

Multi-Channel Signal Analyzer SA-02M  
4-Channel Signal Analyzer SA-02A4



# Multi-Channel Signal Analyzer SA-02M

## 4-Channel Signal Analyzer SA-02A4



# Multi-Channel Signal Analyzer SA-02 Combines 1/1, 1/3, 1/12 Octave Band Analysis Capability

- Up to 32 channels supported (using two SA-02M units)
- Allows high frequency analysis in multiple channels
- Direct sensor connection **TEDS compliant**
- Various analysis software available
- Customizing of analysis software also possible
- Easy operation



## Multi-Channel Signal Analyzer SA-02M **4ch** **8ch** **12ch** **16ch**

Versatile multi-channel configuration suits many applications  
Number of input channels is expandable from 4 to 8, 12, or 16

By linking two SA-02M units, up to 32 channels are supported



# FFT Analysis and



260 mm

AC output connector

58 mm

210 mm

## 4-Channel Signal Analyzer SA-02A4 **4ch**

4 channels fixed  
Compact size

### Rear panel (connector section) SA-02M

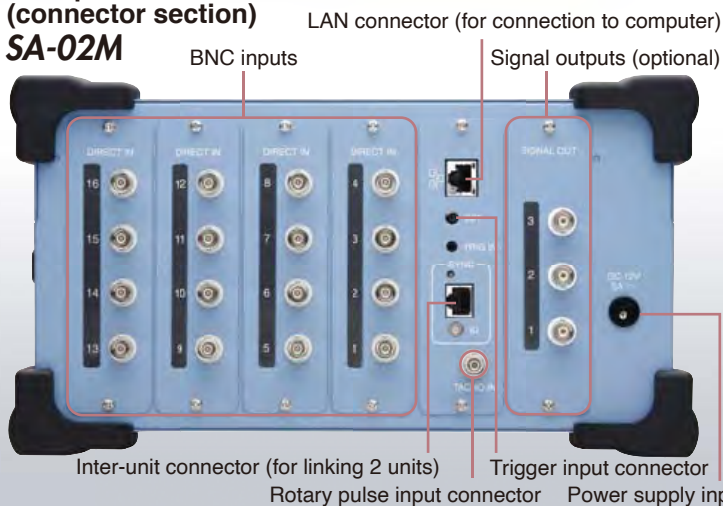

### Rear panel (connector section) SA-02A4

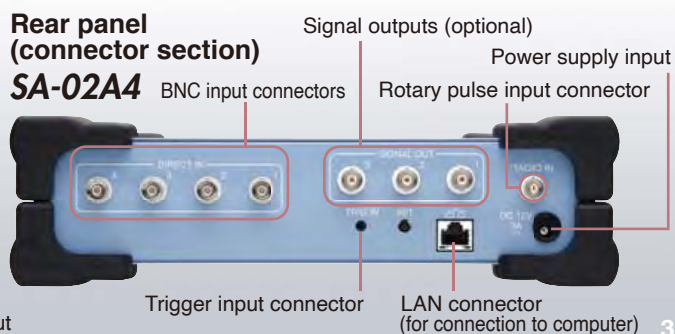

# Connection Examples (Measurement also requires a computer and software)

## Sound level measurement

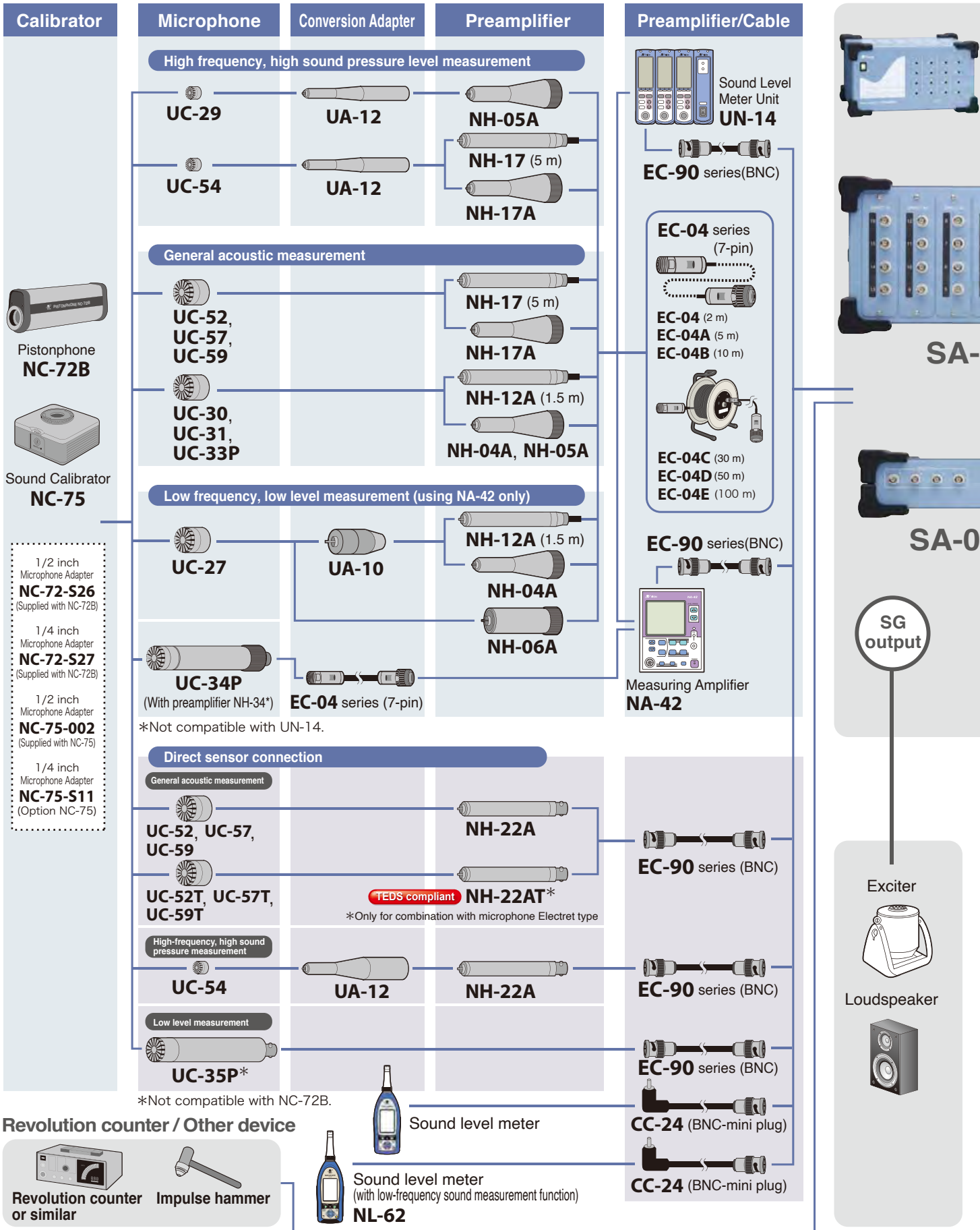

# Vibration measurement

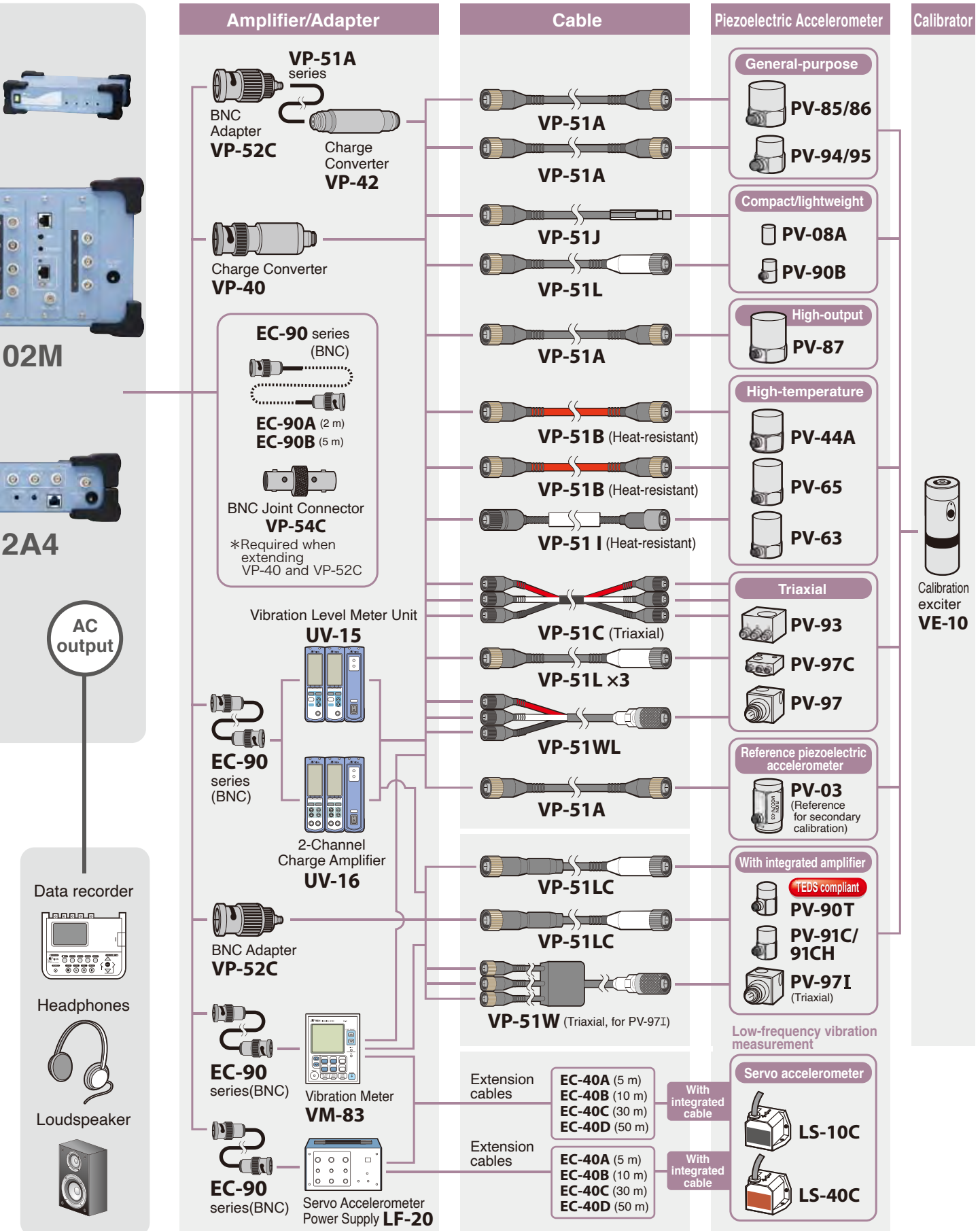

\*Other vibration level meters can also be connected. \*UV-16 and VM-83 are not TEDS compliant.

# Analysis Result Display Examples (Standard Software)

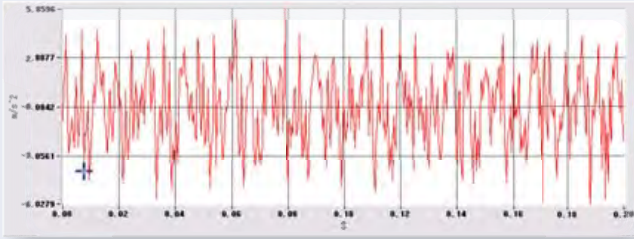

## Time waveform

The time waveform for the number of samples (number of FFT analysis points) is displayed. When time waveform recording was carried out, the waveform for the entire recorded period can be displayed, and secondary processing of various parameters from the recorded waveform is also possible.

This is a graph representing the behavior of a sound or vibration phenomenon as a waveform. The horizontal axis represents the time and the vertical axis the magnitude of the signal. Frequency analysis is performed based on these data.

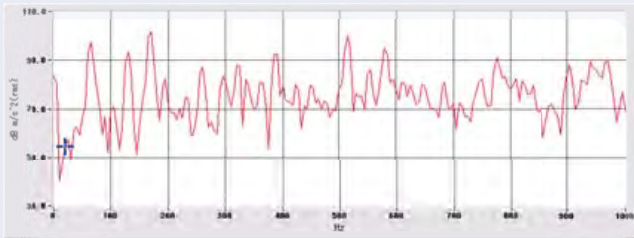

## FFT analysis

When a composite signal that seems to have an irregular pattern is analyzed using Fast Fourier Transform (FFT), certain patterns can be identified and frequency spectrum analysis becomes possible. This technique is particularly effective for examining an audio signal, and it is also widely used in acoustic and vibration signal analysis for applications such as quality evaluation of automobiles or electrical household goods, detection of unusual sounds that are indicative of problems, etc.

Here the FFT analysis result is represented as a graph. The horizontal axis represents frequency and the vertical axis the magnitude of the signal. A characteristic of FFT analysis is that the analysis frequency, number of sampling points, time window function, and overlap ratio can be specified to focus the analysis on a specific frequency, with a specific time resolution. Both average and maximum values can be calculated. FFT analysis is used extensively in development and research applications.

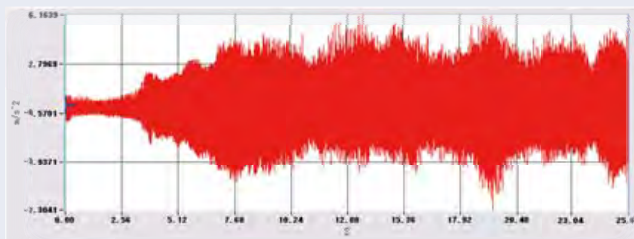

## Time waveform recording

This function allows storing of the time waveform in the memory of the computer. The available recording time depends on the memory capacity of the computer, the number of channels, and the frequency range.

The input signal can be recorded. This makes it possible to (1) play back audio information, and (2) perform repeated analysis of the signal.

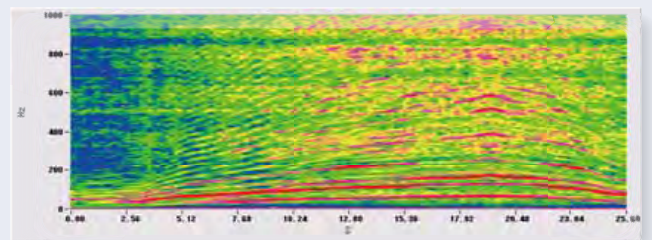
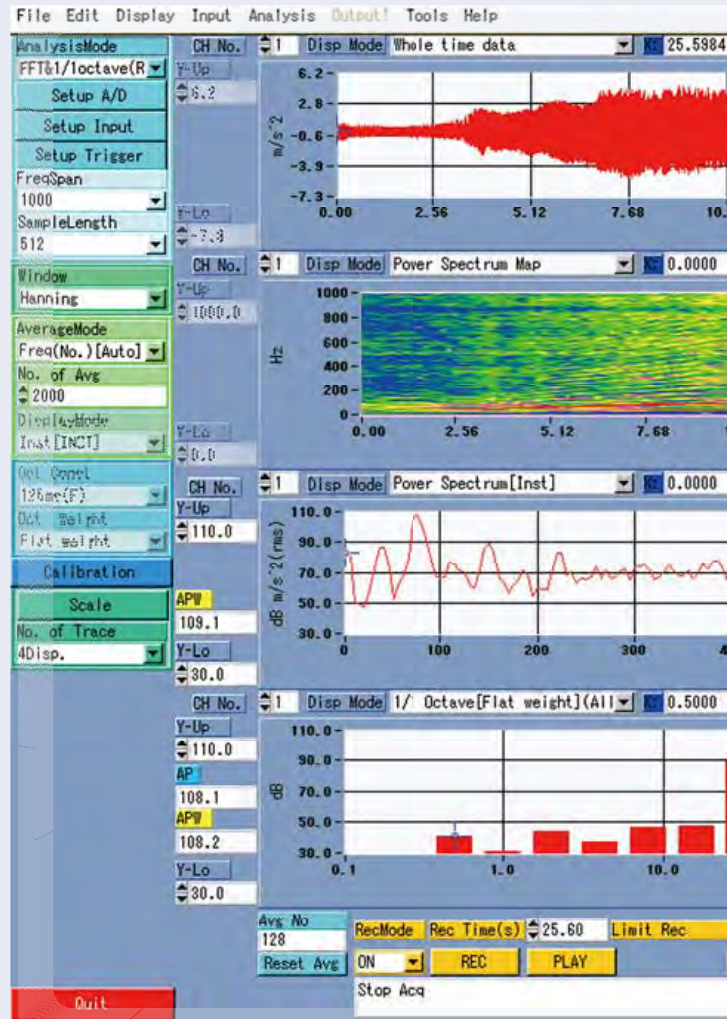

## Power spectrum map, octave map

Using the results of power spectrum and octave band analysis, the time can be plotted on the horizontal axis and the frequency and, using a different color, the level can be plotted on the vertical axis.

The horizontal axis represents the time, while the frequency and level are plotted with different colors on the vertical axis. This results in a display that resembles a voice print analysis screen, providing a visualization of signal level fluctuations.

## Auto-correlation function

This function is used to measure synchronism and affinity conditions within the signal. It is effective in identifying periodic signal occurrences that were buried in random noise.

## Cross-correlation function

By determining affinity between two types of signals, this function allows measuring time lag, transmission path characteristics, and other properties. It is useful for detecting mutual interdependence between signals.

## Basic screen layout

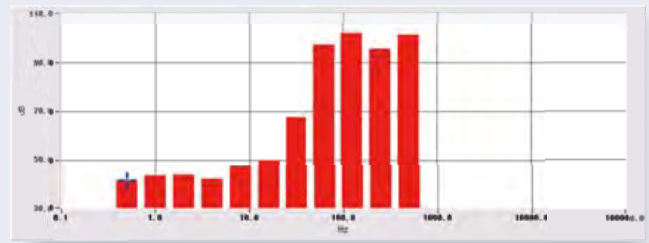
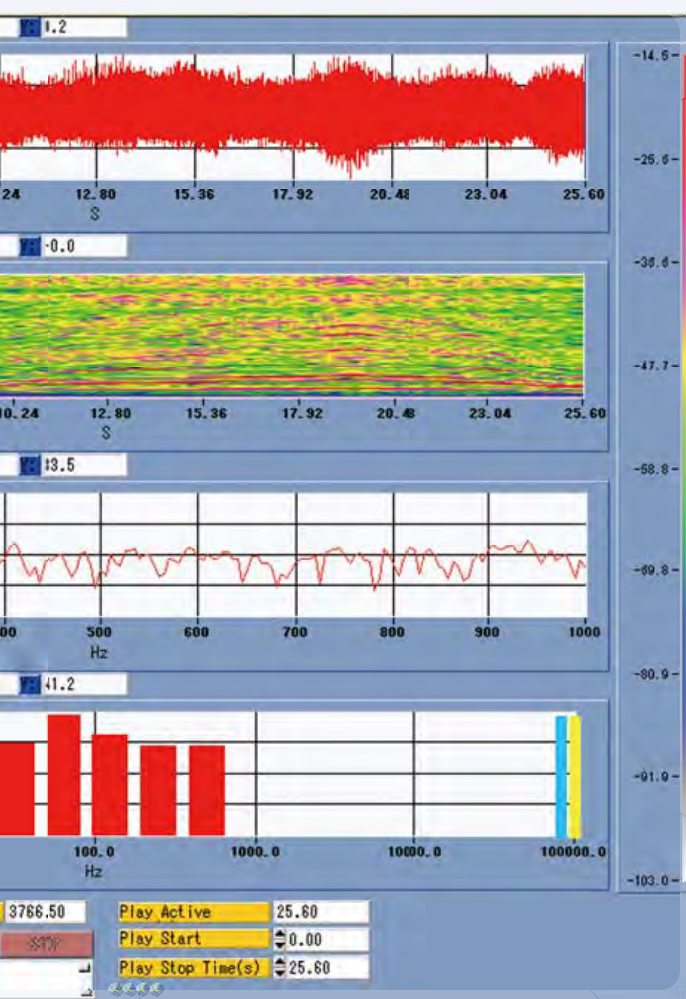

## Octave band analysis

One octave is defined as the interval between two points with a frequency ratio of 1 : 2. An octave bandpass filter therefore is a filter where the upper limit frequency is double that of the lower limit frequency. When performing analysis with the aim of evaluating noise levels or vibration levels and devising countermeasures, octave band filters (1/1 octave, 1/3 octave, 1/12 octave) are usually applied to provide correlation to human sensory perception.

The graph displays the result of octave band analysis. The horizontal axis represents the time and the vertical axis the magnitude of the signal. Major features of octave band analysis are (1) fewer setting items than for FFT analysis, and (2) frequency resolution is logarithmic, which resembles the way such phenomena are perceived by humans. With this type of analysis, the  $L_{eq}$ ,  $L_{max}(AP)$ ,  $L_{max}(\text{Band})$ , and  $L_E$  values can be calculated for each frequency band.

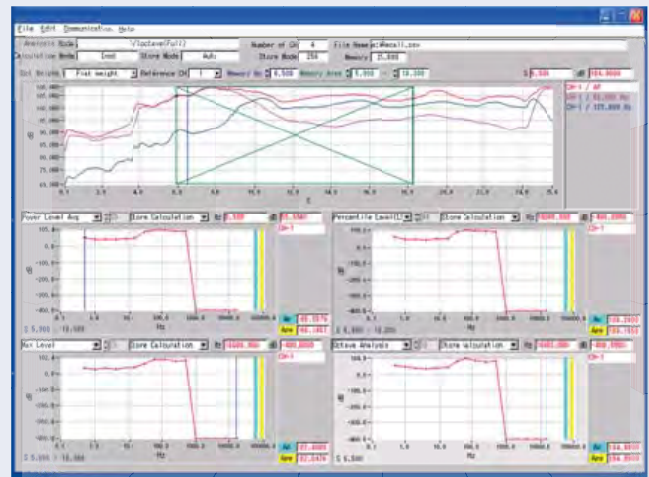

## Recall processing

The results of octave band analysis are used for secondary arithmetic processing.

Octave band analysis offers a so-called "store mode" which allows saving the analysis results at specified intervals during measurement. By recalling these results and performing arithmetic processing on the data, (1) variations over time can be observed, (2) the analysis result for a specific moment can be displayed, and (3) the processing values ( $L_{eq}$ ,  $L_{max}$ ,  $L_X$ ) for a specified range can be displayed.

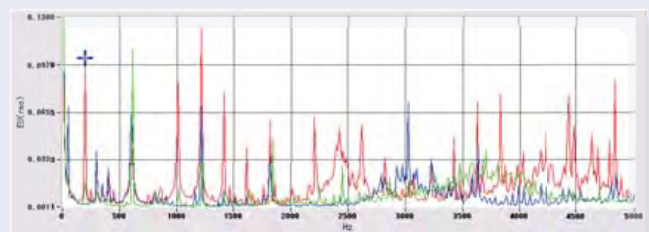

## Overlay display

Several FFT analysis results can be superimposed on screen. This is highly effective for example to judge before/after conditions or to perform visual pass/fail evaluation of data.

## Transfer function, coherence function

The transfer function indicates a ratio between input signal and output signal in the frequency domain, which is displayed as amplitude and phase. The coherence function determines affinity between two signals in the frequency domain. It is expressed as a numeric value between 0 and 1. When the value is close to 0 for a given frequency, correlation between the two signals is low. Higher values tending towards 1 indicate increasing affinity between the two signals. The coherence function is used to evaluate the transfer function results. It is effective for applications such as S/N ratio measurement and determination of sound source influence ratio.

The transfer function is used to examine the relationship between an input signal and an output signal. For example, using an impulse hammer and accelerometer arrangement, the natural vibration frequency of an object can be measured. The coherence function then is helpful to evaluate the data for validity.

## Amplitude probability density function

By numerically determining the probability within a certain amplitude, the statistical properties of a fluctuating signal can be assessed and analyzed.

# Optional Software

## Throughput Disk CAT-SA02-TH (This software is a product of Catec Inc.)

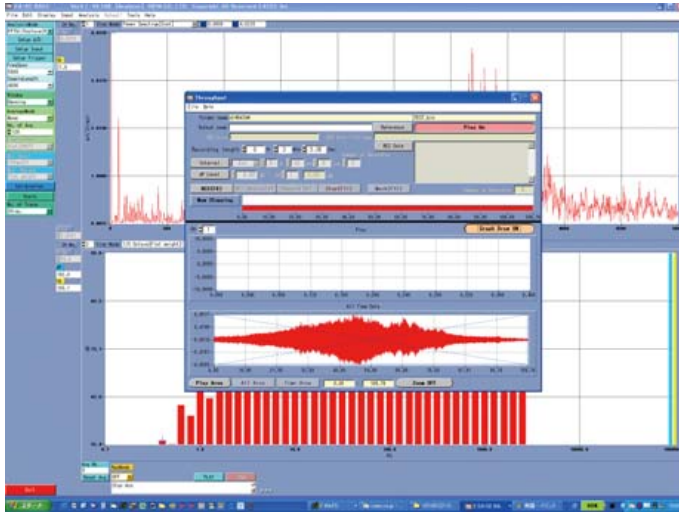

### Long-term time waveform recording

This software enables directly storing time waveform data on the hard disk of a computer for long-term recording. Data stored on the throughput disk can be used for repeated FFT analysis or octave band analysis with different settings. Waveform data from other sources besides the SA-02 can also be handled.

Optional support for the following formats is available:

- TAFFmat format for TEAC DAT media
- PC-SCAN II format for Sony DAT media
- CSV format specified by Rion for time data

## Waveform Data Manipulation Software CAT-SA32 (This software is a product of Catec Inc.)

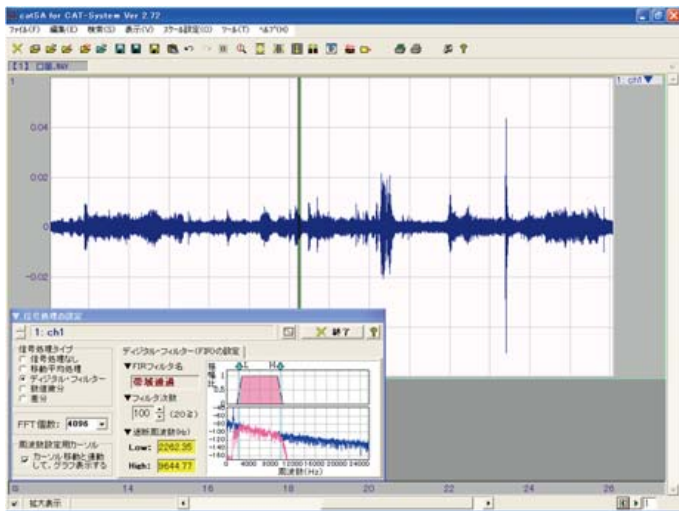

### Versatile data manipulation

Digital filtering, moving average processing, integral processing, differential processing and other functions can be easily performed by mouse operation, and the results are displayed immediately.

### FFT processing

Any part of the waveform can be selected for FFT processing, and the results are displayed immediately.

### Arithmetic processing

Arithmetic formula can be input (basic arithmetic, trigonometric functions, etc.) and used for data manipulation.

### Overlay display

Simply by dragging and dropping a channel name, an overlay display can be created quickly. When data from multiple files are shown in overlay mode, movement on the time axis (shifting the start point) is possible by using the mouse.

### Storing manipulated data

Manipulated data can be stored in CSV or WAVE format, which allows further processing at a later point, or playback as sound.

### Data import function

Data from a data recorder can be imported for manipulation.

## Report Creation Support Tool CAT-Report (This software is a product of Catec Inc.)

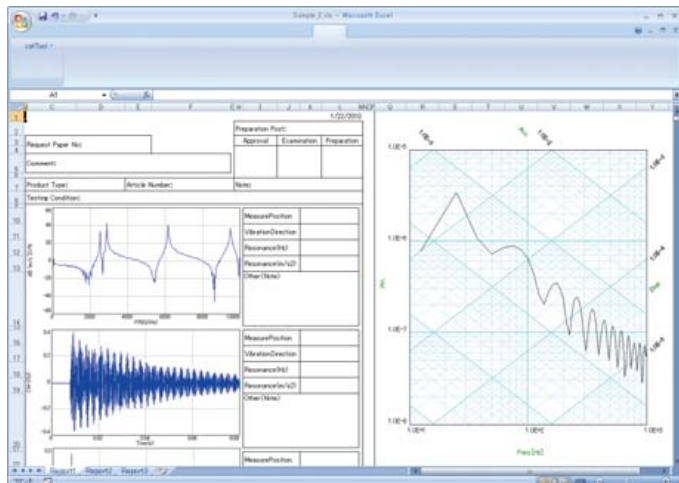

### Excel add-on

Because this is an Excel add-on, it can be easily accessed via the Excel toolbar. Storing as regular XLS files is also supported. Display and printing are possible even when the tool is not installed.

### Ease of operation

A simple button click shows an object area on the sheet, which can be resized and repositioned at will (copying also possible). When an object has been created, settings can be changed with a single button.

### XY graph

Axis settings (maximum value, minimum value, logarithmic axis, etc.) and plot settings (file and channel, etc.) can be made on a dedicated screen with preview capability.

- Any channel can be assigned to the X axis and Y axis.
- Line color, thickness, type, and legend symbols can be specified for each plot.

### Cell linking function

The information from an object can be reflected automatically in a specified cell (for example the maximum value of the waveform in a XY graph).



# Sound and Vibration Measurement System CAT-SA02-Pro

(This software is a product of Catec Inc.)

- Simultaneous analysis, FFT, octave band and recall processing during waveform recording.
- Downsampling FFT
- Two sets of frequencies range and number of sampling points can be handled simultaneously.
- Long-term time waveform recording
- Comments and memo on measurement results
- USB camera or high-speed camera supported (Optional).
- Tracking Analysis and Sound Quality Evaluation supported (Optional).

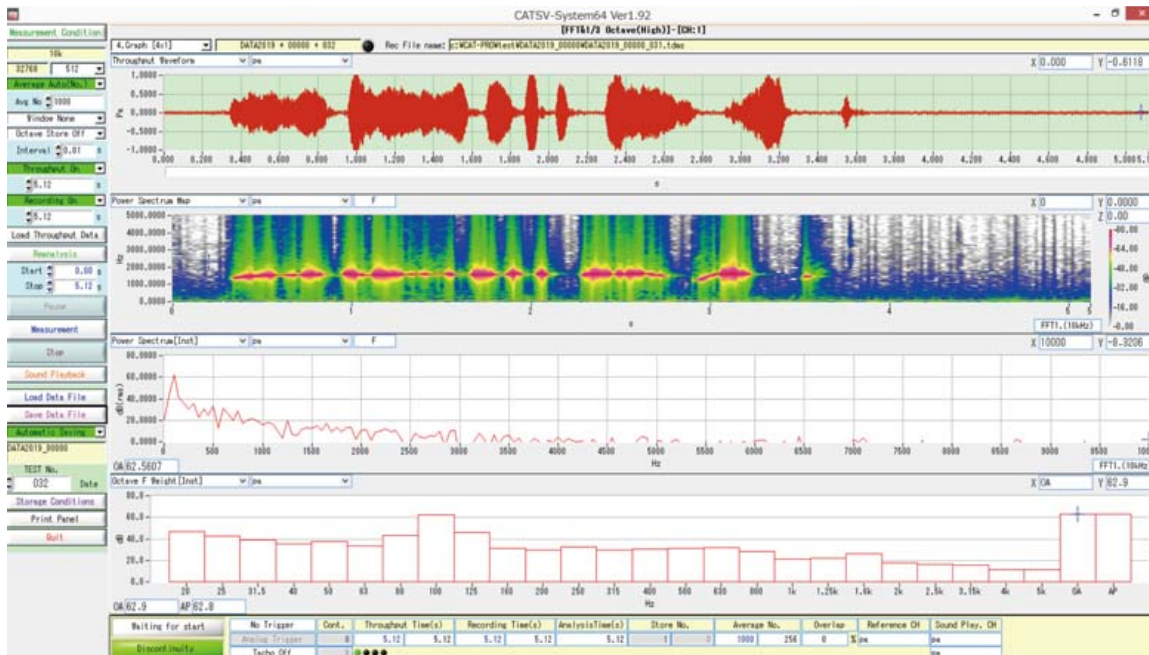

Basic

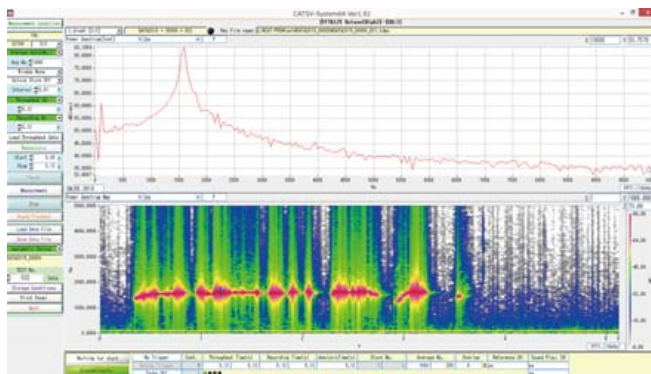

Spectrum map

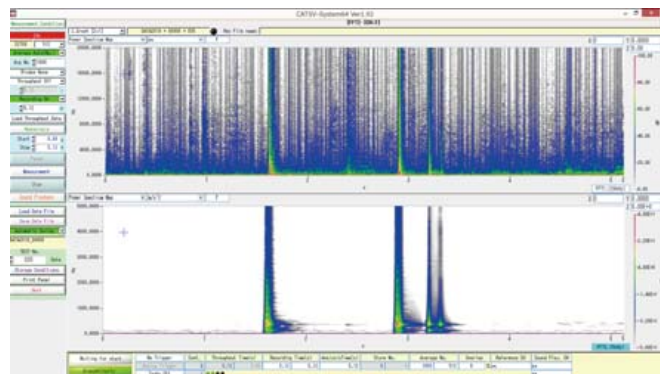

Sound and vibration down-sampling



Recall

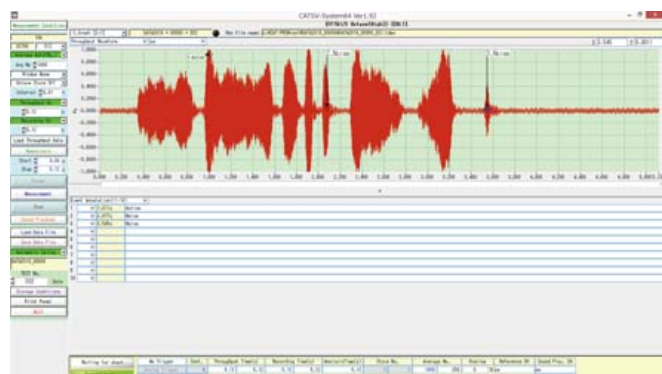

Memo display

# Dedicated Analysis Software

## Airborne Noise/Floor Impact Noise Insulation Measurement Software AS-20PE5

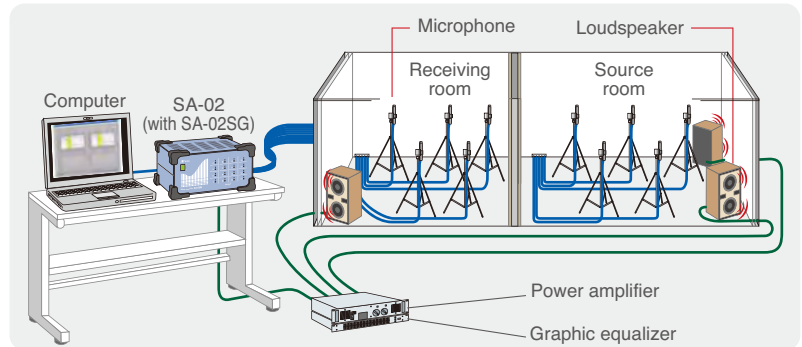
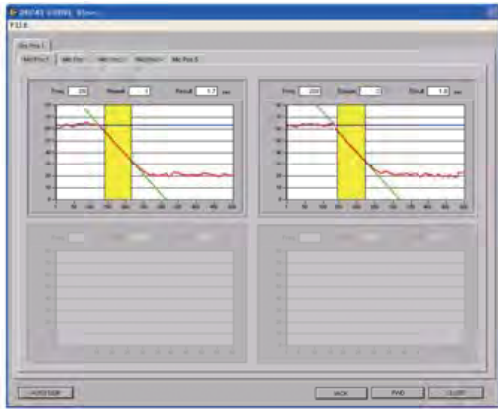

● Designed for sound insulation measurement of buildings and building materials based on JIS specifications. Measurement and evaluation for the categories of reverberation time, floor impact sound and attenuation, airborne sound, and sound absorption in a reverberation room are possible.

● Applicable standards

- ISO 354 Acoustics - Measurement of sound absorption in a reverberation room
- ISO 140-1 Acoustics - Measurement of sound insulation in buildings and of building elements - Part 1: Requirements for laboratory test facilities with suppressed flanking transmission
- ISO 140-3 Acoustics - Measurement of sound insulation in buildings and of building elements - Part 3: Laboratory measurements of airborne sound insulation of building elements
- ISO 140-4 Acoustics - Measurement of sound insulation in buildings and of building elements - Part 4: Field measurements of airborne sound insulation between rooms
- ISO 140-7 Acoustics - Measurement of sound insulation in buildings and of building elements - Part 7: Field measurements of impact sound insulation of floors
- ISO 717-1 Acoustics - Rating of sound insulation in buildings and of building elements - Part 1: Airborne sound insulation
- ISO 717-2 Acoustics - Rating of sound insulation in buildings and of building elements - Part 2: Impact sound insulation
- ISO 140-8 Acoustics - Measurement of sound insulation in buildings and of building elements - Part 8: Laboratory measurements of the reduction of transmitted impact noise by floor coverings on a heavyweight standard floor

## Sound Power Level Measurement Software for Hemi-anechoic Room AS-30PA5

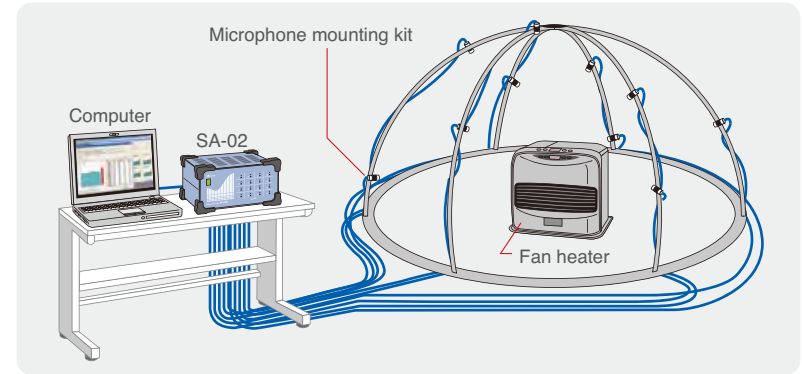
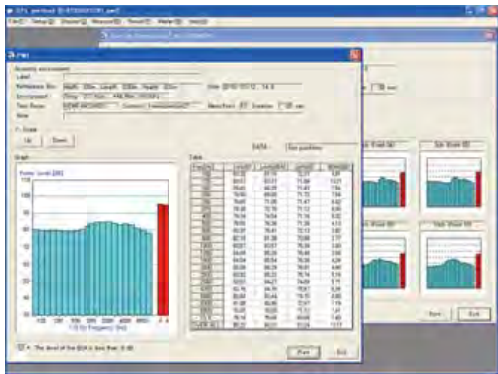

- Allows 1/3 octave band acoustic power level measurements, according to specifications for acoustic power level measurements in hemi-anechoic chambers.
- Sound pressure level values are measured in a hemi-anechoic chamber using measurement points arranged on a virtual measurement surface (hemispheric, cuboid). While applying background noise compensation for the sound pressure level at the sound source, the FLAT characteristics acoustic power level and A-weighted acoustic power level values are determined.
- Applicable standards ISO 3745 Acoustics - Determination of sound power levels of noise sources using sound pressure - Precision methods for anechoic and hemi-anechoic rooms  
ISO 3744 Acoustics - Determination of sound power levels of noise sources using sound pressure - Engineering method in an essentially free field over a reflecting plane

## Sound Power Level Measurement Software for Reverberation Room AS-31PA5

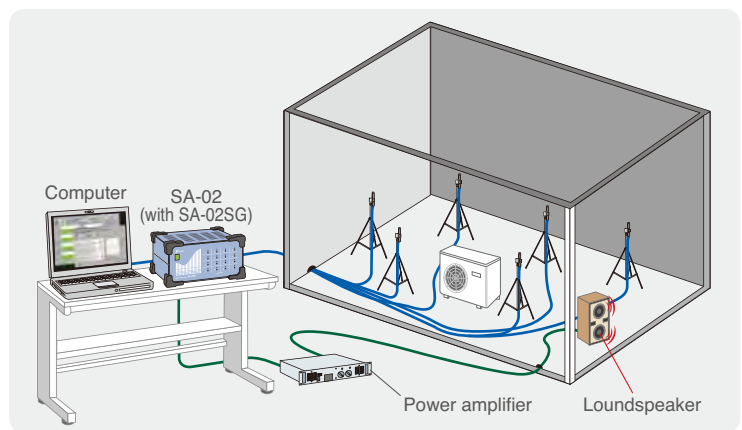
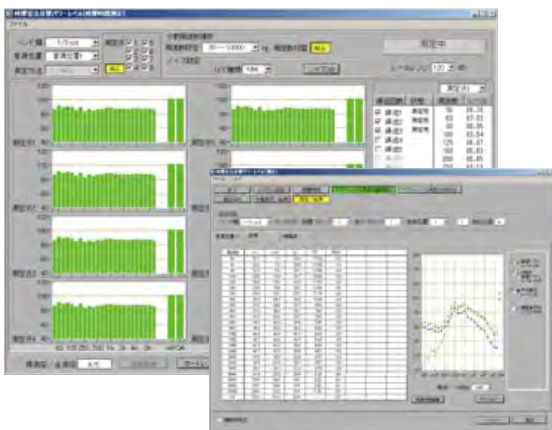

- Supports direct and comparative measurement. Also allows reverberation time measurement.
- Supports multi-channel measurement and microphone rotator use.
- Simultaneous power level measurement for up to 32 channels possible (up to 8 channels for reverberation time measurement).
- Applicable standards ISO 3741: 1999 Acoustics - Determination of sound power levels and sound energy levels of noise sources using sound pressure - Precision methods for reverberation test rooms

## Loss Factor Measurement Software AS-14PA5

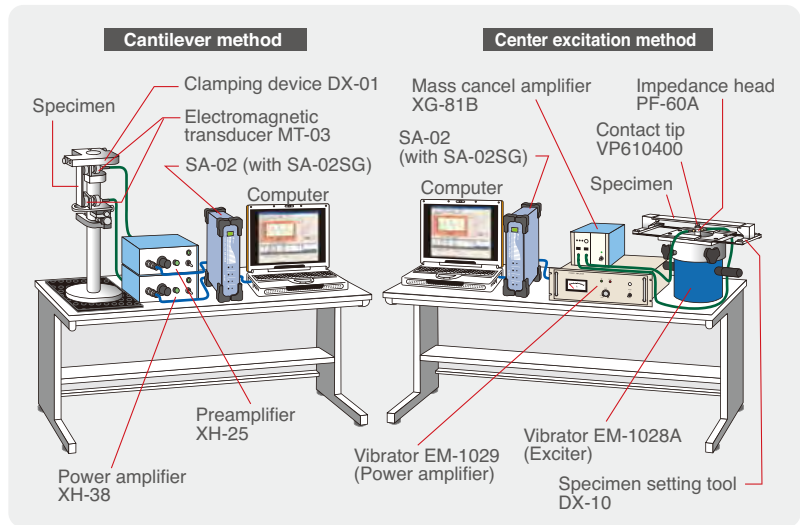
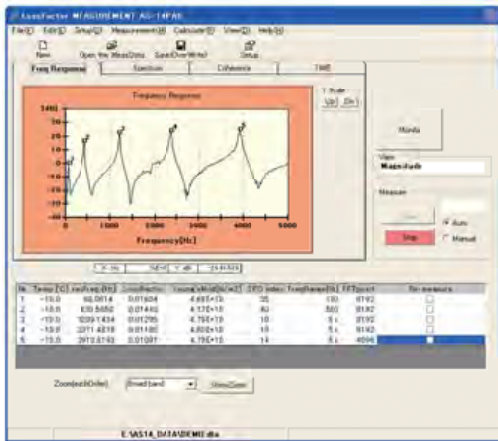

- Using the center excitation method or cantilever method, the frequency response of a strip specimen is measured, and the resonance characteristics are used to determine the loss factor and Young's modulus (or shear coefficient) of the specimen according to the half-power bandwidth method.
- Automatic measurement including temperature control of a thermostatic chamber is supported.

\* When performing vibration attenuation testing for non-constraint compound damping, "Monogram display of damping material characteristics" is supported with optional software.

## Acoustic Intensity Measurement Software AS-15PA5

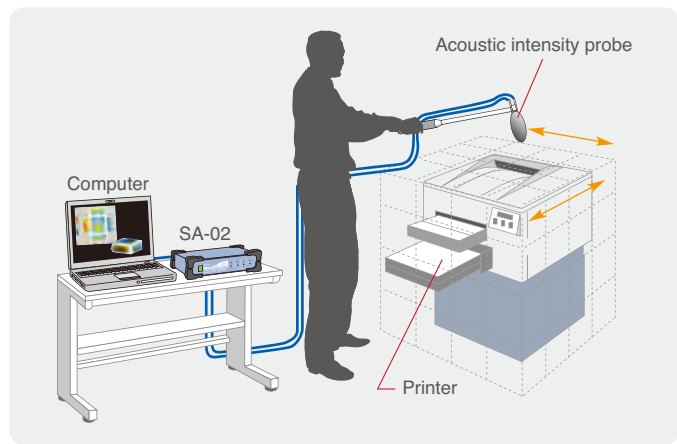
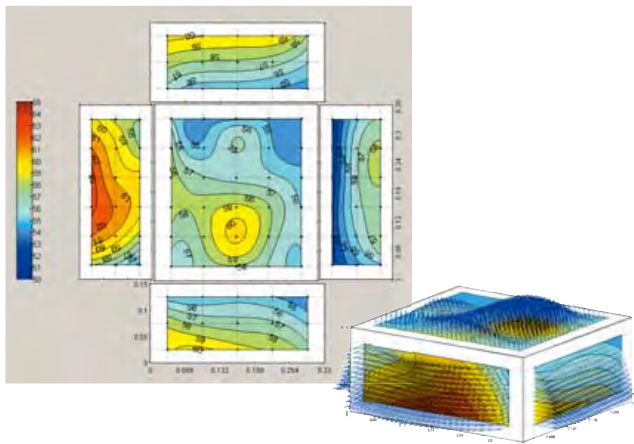

- Calculates acoustic intensity and performs graphics processing.
- Displays frequency spectrum, band level, and intensity spectrum information as spectrum line diagram, contour diagram, or mesh diagram, and shows acoustic power levels.

## Sound Source Location Software AS-16PA5

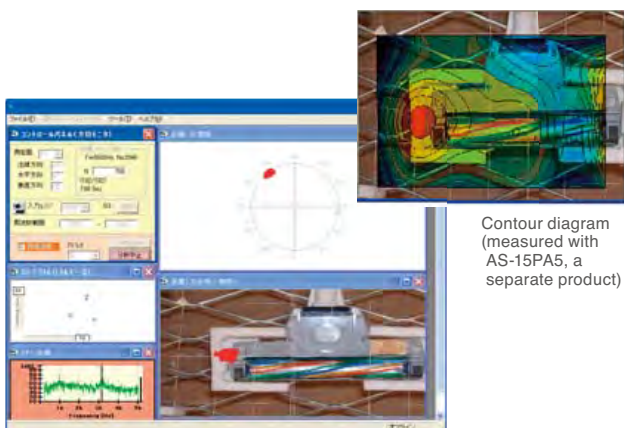

Contour diagram (measured with AS-15PA5, a separate product)

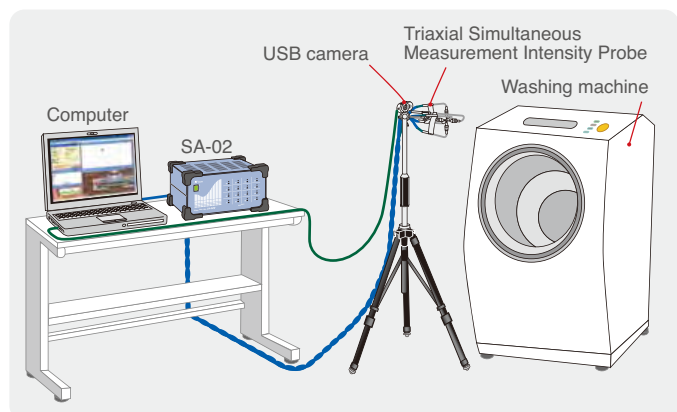

- Determines sound incident direction using a 3-axis acoustic intensity probe, and displays it on screen along with a camera image.
- Overlays presumed sound source location with captured image and allows selecting the frequency (range) to analyze.
- Also supports moving sound source measurement on video (option).

# Dedicated Analysis Software

## Tracking Analysis Software CAT-SA02-Order (This software is a product of Catec Inc.)

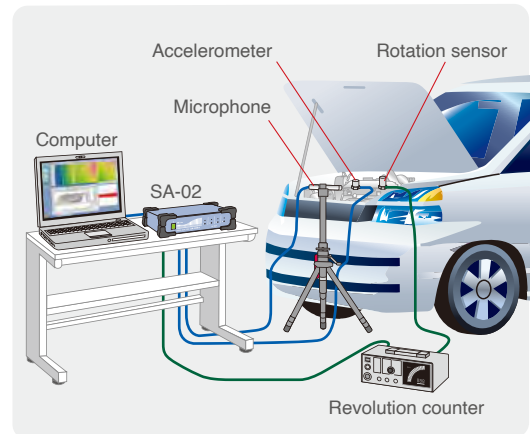
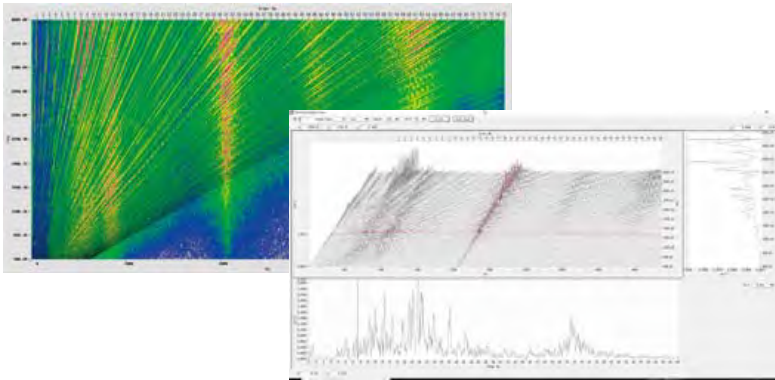

- Rotation data and sound/vibration data are recorded simultaneously to analyze the rotation order ratio.
- Available display formats include three-dimensional mapping, Campbell diagram, rpm-level display and more.

## Mode Analysis Software ME'Scope VES (This software is a product of Vibrant Technology Inc.)

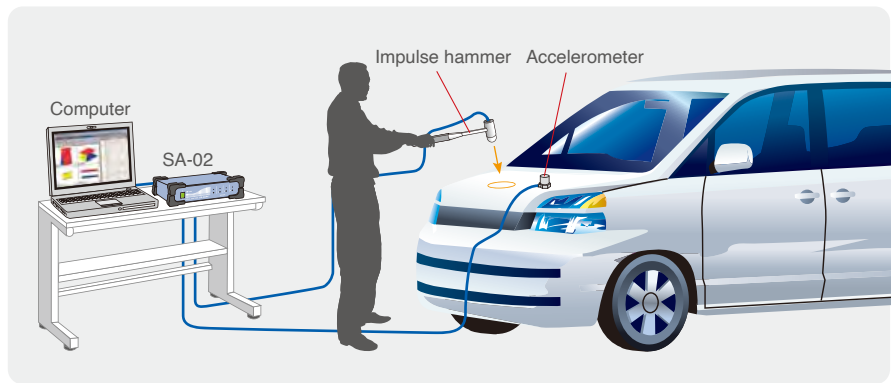
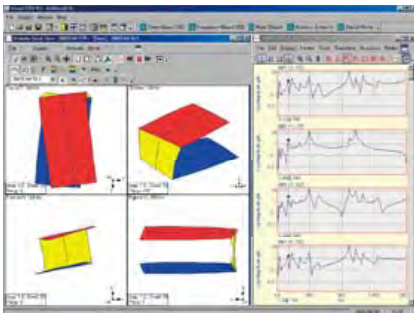

- Allows direct linking of SA-02 and mode analysis software
- Measurement points and direction for each channel can be displayed on screen using arrows, making it easy to check the next measurement point.
- Analysis using animated display can be generated in a few steps.

## Sound Quality Evaluation Software CAT-SA02-SQ (This software is a product of Catec Inc.)

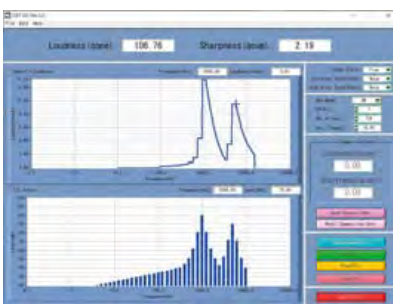

Steady-state loudness and steady-state sharpness

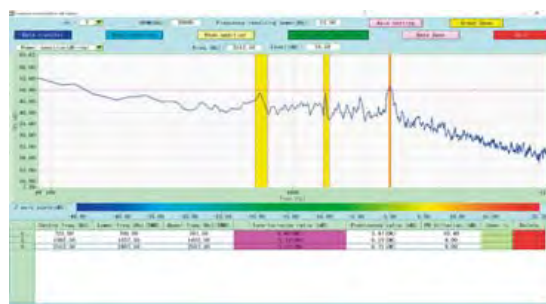

Tonality evaluation (TNR, PR)

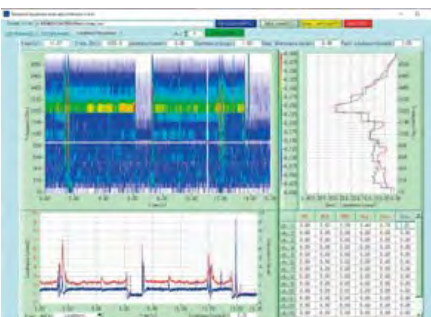

Transient loudness (DIN4563/A1 compliant)  
Transient sharpness

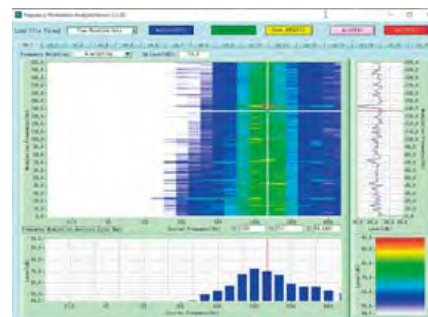

Modulation Frequency Analysis

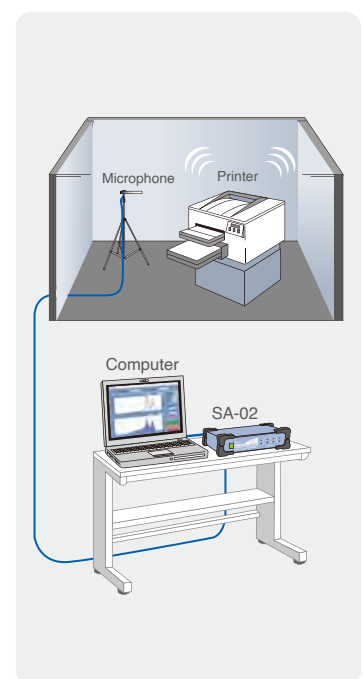

- WAVE data collected with the SA-02 and similar data can be imported into a measurement data file and used to calculate psychoacoustic evaluation quantities.
- Calculates loudness (steady-state and transient\*), sharpness, roughness, intensity fluctuation, and tonality evaluation parameters. \*Calculation of transient loudness available as an option.

## Sound Transmission Loss Measurement System using SI technique (This software is a product of Catec Inc.)

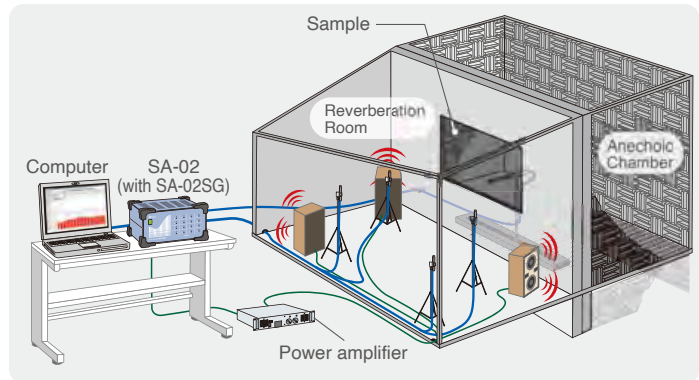
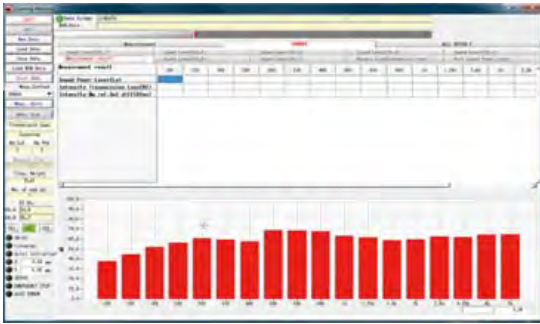

- Allows sound transmission loss to be measured using an acoustic intensity probe
- Can also measure surface and sound power levels
- Capable of automatic measuring in conjunction with a traverse system
- Applicable standards ISO 15186-1:2000, Acoustics—Measurement of sound insulation in buildings and of building elements using sound intensity—Part 1: Laboratory measurements
- Supports scanning and discrete point methods (optional)

## Sound Absorption Coefficient Measurement System for Reverberation Room (This software is a product of Catec Inc.)

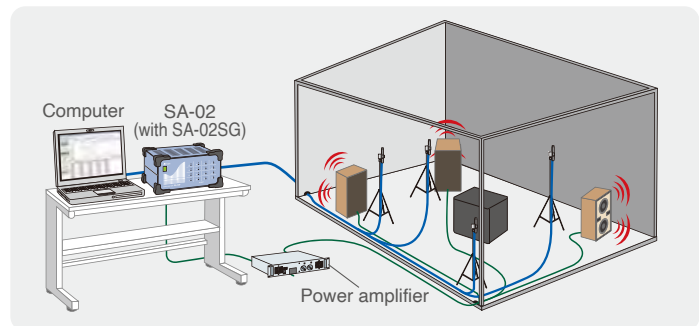
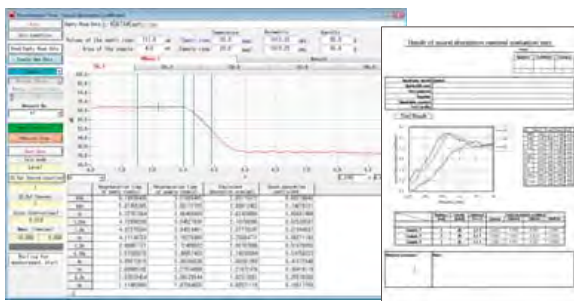

- Speaker and microphone positions can be switched for measurements
- Supports the intermittent noise method and integrated impulse response method (Schroeder method)

## Hand-arm Vibration Measurement Software CAT-SA02-HT (This software is a product of Catec Inc.)

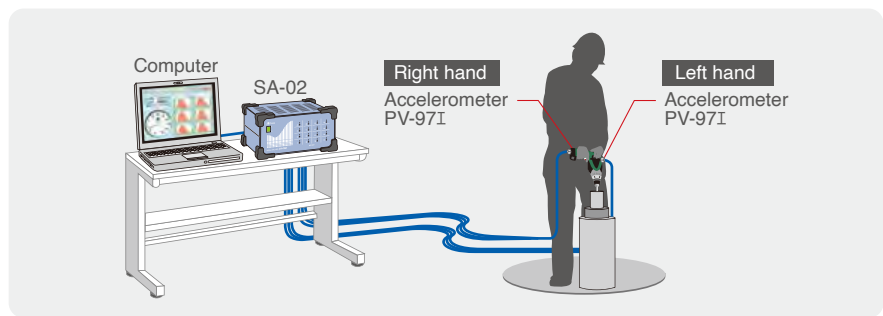
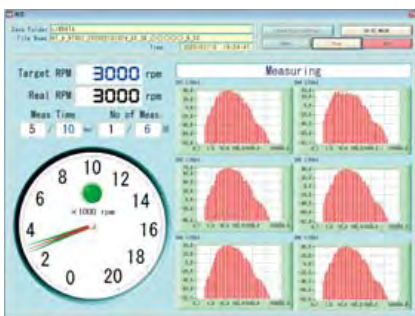

- Applicable standards ISO 8041 Human response to vibration - Measuring instrumentation  
ISO 5349-2 Mechanical vibration - Measurement and evaluation of human exposure to hand-transmitted vibration - Part 2: Practical guidance for measurement at the workplace
- Frequency-weighted acceleration rms values are measured for the X, Y, Z axes simultaneously. From these values ( $a_{hx}$ ,  $a_{hy}$ ,  $a_{hz}$ ), the software determines the triaxial combined value  $a_{hr}$ .

## Sound Power Level Measurement System for Construction Machinery CAT-SA02-CPWL (This software is a product of Catec Inc.)

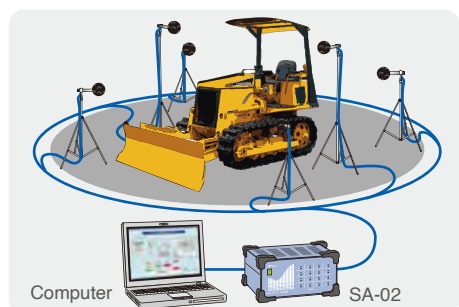
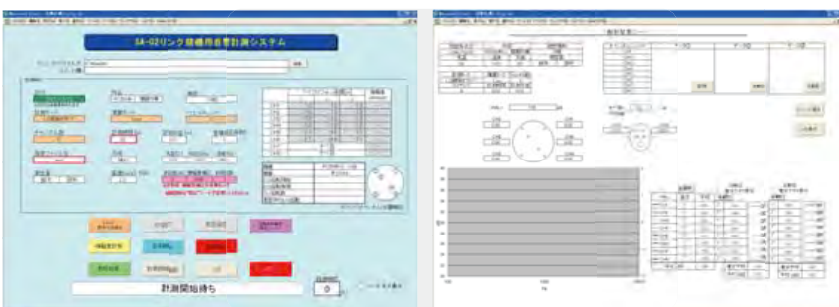

- Applicable standards ISO 4872 Acoustics - Measurement of airborne noise emitted by construction equipment intended for outdoor use - Method for determining compliance with noise limits  
ISO 6395 Earth-moving machinery - Determination of sound power level - Dynamic test conditions ISO 6393 Earth-moving machinery - Determination of sound power level - Stationary test conditions
- Using an Excel macro, the acoustic power level of construction machinery can be measured.

## Array Type Visualization Software CAT-SA02-AR (This software is a product of Catec Inc.)

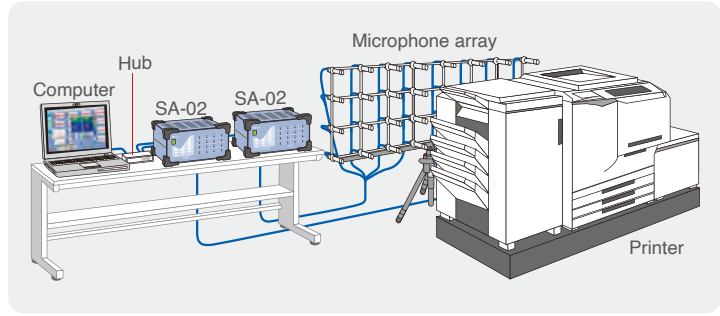
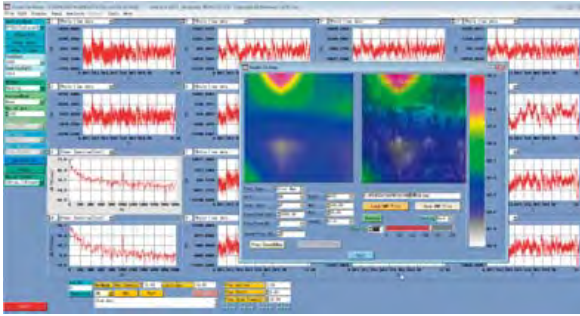

- Sound pressure level fluctuations and changes are made visible using a 32-microphone array.
- Visualization can be performed separately by frequency or overall. Microphone frequency analysis results can be displayed for each mode.
- Power spectrum and 3-D spectrum map can be observed for each array element, based on sound pressure level at the measurement position. Overlay with image data from a digital camera or similar is also possible.

## Envelope Analysis Software CAT-SA02-ENV (This software is a product of Catec Inc.)

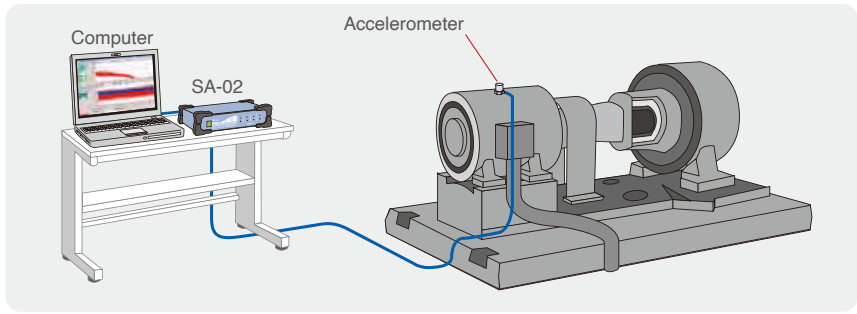
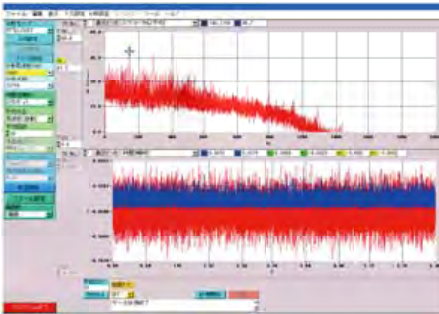

- Designed for bearing problem diagnosis
- Envelope analysis produces equidistant peaks.
- When the bearing part dimensions, number of rolling elements, axis rpm and other parameters are known, the primary frequency of the aligned peaks can be used to pinpoint problem locations.

## External Control Library (This software is a product of Catec Inc.)

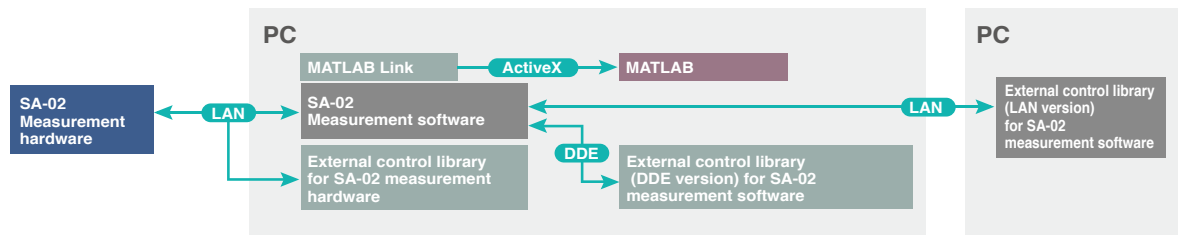

### External Control Library for Measurement Software

**DDE Version**      **LAN Version**  
 CAT-SA02-LIBDDE      CAT-SA02-LIBLAN

This control library (DLL) for SA-02 measurement software can be called from Excel, VB, VC, or LabVIEW. By using this library, measurement start and stop, measurement data transfer function (via memory), and other functions can be controlled. For control operation within the same computer, the DDE version should be used. If control is to be performed among different computers, the LAN (TCP/IP) version is suitable.

### External Control Library for Measurement Hardware (Lab VIEW Compatible)

CAT-SA02-LIBBLV

This control library (VI, DLL) for SA-02 measurement hardware can be called from LabVIEW, VB, VC, or similar. By using this library, the functions of the SA-02 measurement hardware can be controlled directly, without going through the SA-02 standard software. This makes it possible to configure purpose-built systems. Unlike the external control library for SA-02 measurement software, this library consists of hardware control functions (VI).

### MATLAB Link CAT-SA02-LIBMAT

Allows sending measurement data in real time to MATLAB (via memory), enabling the execution of scripts created in MATLAB. This is equivalent to using MATLAB as the user language of the SA-02. The MATLAB user can make SA-02 measurement settings and then create programs for value analysis within MATLAB, using regular procedures. Measurement and numeric analysis can therefore be implemented in real time.

# CUSTOMIZATION

RION is offering a range of optional software for various measurement scenarios, but we can also further customize the software to adapt to the specific needs of our customers.

This can provide a further efficiency boost for production line testing and for research and development applications.



## Customization flow

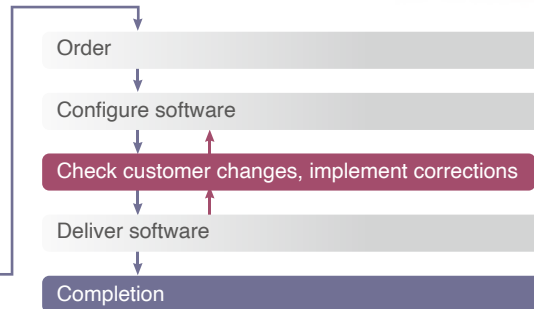
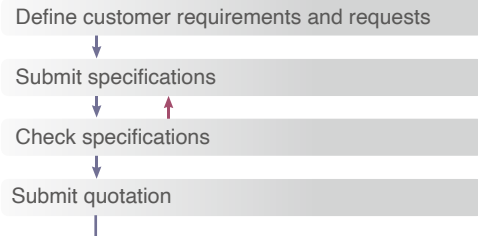

## Some customization examples

### Car interior sound measurement system

- Using the SA-02, this system is designed to allow easy measurement of vibrations occurring in a running car.
- The system covers all steps from tracking analysis to report creation.

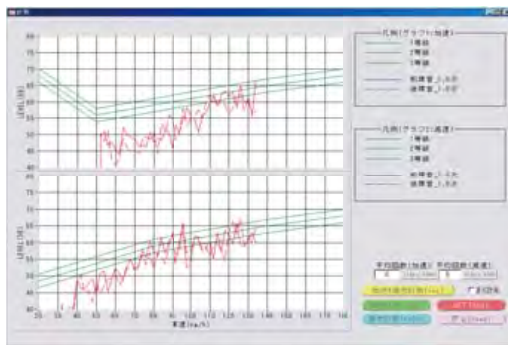

### Measurement system for train sound and vibration.

- This vibration sound analysis software enables the SA-02 to be used for measuring train noise.
- Vibrations and sound caused by the passing of a train can be analyzed and a report can be created with a few simple steps.

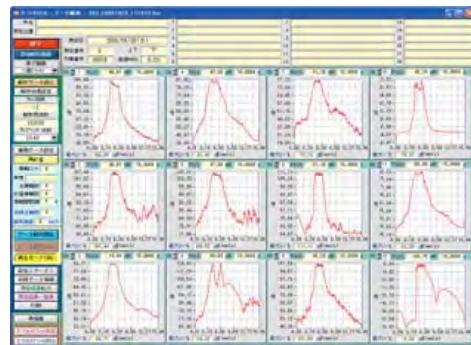

### Automatic measurement system for washing machine vibrations

- Vibrations occurring at various stages of the washing machine cycle (water inflow, washing, spin dry etc.) are measured and recorded, along with rpm data. The system then automatically compiles maximum values for each stage in a list and creates a report.

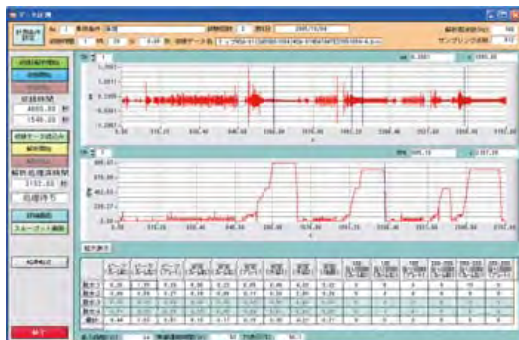

### Speaker Performance Measurement System

- The system uses the SA-02 to measure properties such as frequency response, harmonic distortion, and impedance characteristics.
- Usage with a rotating stage allows measurement of directivity.



# Specifications

Standard compliance	1/1, 1/3, 1/12 octave band filters: IEC 61260-1: 2014 class 1 (JIS C 1513-1: 2020 (Filter), JIS C 1514: 2002 class 1), WEEE Directive, RoHS Directive, Chinese RoHS Directive			
Input section				
Number of channels	SA-02A4	4 channels		
	SA-02M	4 channels (standard) 8 channels (with 1 SA-02E4 unit) 12 channels (with 2 SA-02E4 units) 16 channels (with 3 SA-02E4 units) Max. 32 channels (using two SA-02M)		
Connectors	Type	BNC x number of channels		
	Max. input voltage	±20 V		
	Input impedance	100 kΩ		
	CCLD	4 mA, 24 V (separate on/off setting for each channel)		
	Input coupling	AC/DC (separate setting for each channel), 0.05 Hz (-3.0 dB, 6.0 dB/oct, for AC coupling)		
	TEDS	TEDS sensor compliant		
Range (per channel)	-40 dB to +20 dB, 10-dB steps (taking 1 Vrms as 0 dB)			
Amplifier section				
Frequency range	DC to 40 kHz			
Analog filters (per channel)	Frequency filters (per channel)			
	High-pass filter (HPF)	OFF / 20 Hz (-1.0 dB, 18 dB/oct)		
	Low-pass filter (LPF)	OFF / 1 kHz (-1.0 dB, 18 dB/oct) / 20 kHz (-1.0 dB, 18 dB/oct)		
Frequency weighting characteristics	FLAT / A / C (A and C available only when both HPF and LPF are OFF) (A and C characteristics corresponding to JIS C 1509-1, class 1)			
Residual noise	-85 dB or less (all-pass level, 0 dB range) -105 dB or less (all-pass level, -40 dB range, Vrms = 1 V as 0 dB)			
Crosstalk	-105 dB or less (1/3 octave, 0 dB range, 1 kHz band)			
Overload level	+2 dB of range full-scale			
A/D converter section				
A/D converter	Simultaneous sampling of all channels 24-bit Σ-Δ type converter Sampling frequency 102.4 kHz			
FFT analyzer section	Analysis frequencies	100 Hz / 200 Hz / 500 Hz / 1 kHz / 2 kHz / 5 kHz / 10 kHz / 20 kHz / 40 kHz		
	Number of analysis points	64 / 128 / 256 / 512 / 1024 / 2048 / 4096 / 8192 / 16384 / 32768		
	Overlap ratio	0 % / 50 % / 75 % / 87.5 % / 93.75 %		
	Time window functions	Rectangular / Hanning / Flat-top / Exponential / Force Exponential		
	Processing functions			
	Linear averaging	Averaging count setting range: 2 to 10000		
	Exponential averaging	Averaging constant setting range: 1/2 to 1/512		
	Maximum value hold	Monitored for every frame analysis, maximum value held for every frequency Maximum value detection count setting range: 2 to 10000		
	Functions			
	Frequency domain	Spectrum, cross-spectrum, transfer function, coherence		
Time domain	Autocorrelation, cross-correlation, amplitude probability density, amplitude probability distribution			
Octave band analyzer section	Analysis band range			
	Number of channels used	1 to 4	5 to 8	9 to 16
	Analysis mode	1/1	0.5 Hz to 16 kHz	
		1/3	0.4 Hz to 20 kHz	
		1/12	0.36 Hz to 22 kHz*	0.36 Hz to 11 kHz*
	* Depending on number of channels used per unit			
	Time weighting characteristics (per channel)	1 ms / 10 ms / 35 ms / 125 ms (F) / 630 ms (VL) / 1s (S) / 10 s		
	Processing functions			
	Linear averaging	Processing time 1 to 3600 s, direct calculation from filter output waveform		
	Maximum value hold	Instantaneous value for every sample is monitored and held		
Maximum value hold type				
Band	Monitored and held for every frequency band			
All-pass	Maximum value of all-pass band is monitored, and maximum values for all frequency bands at that point are stored			
Memory functions				
Store data	Instantaneous value / linear average value / maximum value tach pulse (only with compatible software)			
Store cycle	Instantaneous value 1 ms to 1000 ms (1-ms steps)			
Maximum number of store data				
Analysis mode	1/1 : 36000, 1/3 : 36000, 1/12 : 18000			

Display section	Number of windows	2 / 4 / 8 / 12 / 16 / 32	
	FFT analysis	Functions calculated with FFT are shown (dependent on FFT analysis functions)	
	Octave band analysis	1/1, 1/3, 1/12 octave band analysis results and processing results are shown	
Recording section			
File input/output	Test parameter file	Settings can be saved to and loaded from a file	
	Data file	Analysis data can be saved to and loaded from a file in CSV format	
	JPEG file	Graphs can be saved to a file in JPEG format	
Copy function	A specified graph or the entire window can be copied to the clipboard		
Input/output section			
AC output connectors	Type	2.5 dia. mono mini jack x number of channels	
	Output impedance	600 Ω	
	Output voltage	1 Vrms (at full-scale input range)	
	Output signal	Routed through analog filter before output	
Trigger input connector	Type	2.5 dia. mono mini jack x 1	
	Input signal	Open collector supported 5 V input, TTL level threshold	
Rotary pulse input connector	Type	BNC x 1	
	Input signal	Rotary pulse, 0 to 10 V	
	Input impedance	100 kΩ	
	H-L threshold	1 to 4 V, changeable in 0.1-V steps	
	Pulse measurement method	Cycle measurement with 12.5 MHz sampling	
	Measurement range	30 to 600000 pulses/minute	
Data save cycle	Time waveform transfer mode: sampling frequency of A/D converter Octave mode: every 100 ms		
LAN connector	RJ-45 x 1, 100 Base -TX		
Inter-unit connector	RJ-45 x 1, cable length 50 cm (SA-02M only)		
Other items			
Calibration and engineering units	Analysis result readout values are calibrated, or engineering units selected, according to sensitivity of connected sensor		
	Calibration	Using calibration value or calibration signal	
Printing	A specified graph or the entire window can be printed		
Power	Supply principle	AC adapter NC-99A (supplied)	
	Voltage range	9 to 15 V DC	
	Power consumption (without option units, using NC-99A)	SA-02A4: approx. 30 VA	
		SA-02M (4 channels installed): approx. 30 VA	
		SA-02M (8 channels installed): approx. 40 VA SA-02M (12 channels installed): approx. 50 VA SA-02M (16 channels installed): approx. 60 VA	
Environmental conditions for use	0 °C to 40 °C, max. 90 % RH (no condensation)		
Supplied accessories	SA-02 Install CD x 1	AC adapter x 1	
	LAN cable (cross-wired) for connection to computer (STP cable is recommended) x 1 USB protection key x 1		
Dimensions, Weight	SA-02A4	58 (H) x 260 (W) x 210 (D) mm (without protruding parts and rubber feet)	
		Approx. 2.5 kg	
	SA-02M	151 (H) x 290 (W) x 249 (D) mm (without protruding parts and rubber feet)	
		4 channels installed	Approx. 5.4 kg
		8 channels installed	Approx. 5.9 kg
12 channels installed	Approx. 6.3 kg		
16 channels installed	Approx. 6.8 kg		

\* A computer is not supplied.

## Hardware options

Product	Model number
4-Channel Input Unit	SA-02E4
Signal Output Unit	SA-02SG
Connecting kit	—

\* For SA-02M, when more than 16 channels are required.

## Recommended computer specifications

CPU	Intel Core i5/i7 1.4 GHz or higher (Core 2 Duo 2 GHz or higher)
RAM	2 GB or more
Display	XGA (1024 x 768) or higher, 65536 colors or more
Operating system	Microsoft Windows 8.1 Pro 32 bit / 64 bit, 10 Pro 32 bit / 64 bit



**JCSS**  
JCSS 0197

RION CO., LTD. is recognized by the JCSS which uses ISO/IEC 17025 as an accreditation standard and bases its accreditation scheme on ISO/IEC 17011. JCSS is operated by the accreditation body (IA Japan) which is a signatory to the Asia Pacific Accreditation Cooperation (APAC) as well as the International Laboratory Accreditation Cooperation (ILAC). The Quality Assurance Section of RION CO., LTD. is an international MRA compliant JCSS operator with the accreditation number JCSS 0197.



ISO 14001 RION CO., LTD.  
ISO 9001 RION CO., LTD.

\* Windows is a trademark of Microsoft Corporation. \* Specifications subject to change without notice.

Distributed by:



3-20-41, Higashimotomachi, Kokubunji, Tokyo 185-8533, Japan  
Tel: +81-42-359-7888 Fax: +81-42-359-7442