



Table of Contents

Instrument Set-up	2	Limits of use	11
Introduction	2	Disposal	11
Overview	2	Electromagnetic Compatibility (EMC)	11
Display	3	FCC statement (applicable in U.S.)	12
Insert batteries	3	Laser classification	12
Operations	4	Labelling	12
Switching ON/OFF	4		
Clear	4		
Message Codes	4		
Adjusting measuring reference	4		
Distance unit setting	4		
Measuring Functions	5		
Measuring single distance	5		
Permanent measuring	5		
Add / Subtract	5		
Area	6		
Volume	6		
Pythagoras (2-point)	7		
Pythagoras (3-point)	7		
Memory (5 last results)	8		
Technical Data	9		
Message Codes	10		
Care	10		
Safety Instructions	10		
Areas of responsibility	10		
Permitted use	11		
Prohibited use	11		
Hazards in use	11		

Instrument Set-up

Introduction

 The safety instructions and the user manual should be read through carefully before the product is used for the first time.

 The person responsible for the product must ensure that all users understand these directions and adhere to them.

The symbols used have the following meanings:

WARNING

Indicates a potentially hazardous situation or an unintended use which, if not avoided, will result in death or serious injury.

CAUTION

Indicates a potentially hazardous situation or an unintended use which, if not avoided, may result in minor injury and/or appreciable material, financial and environmental damage.

 Important paragraphs which must be adhered to in practice as they enable the product to be used in a technically correct and efficient manner.

Overview

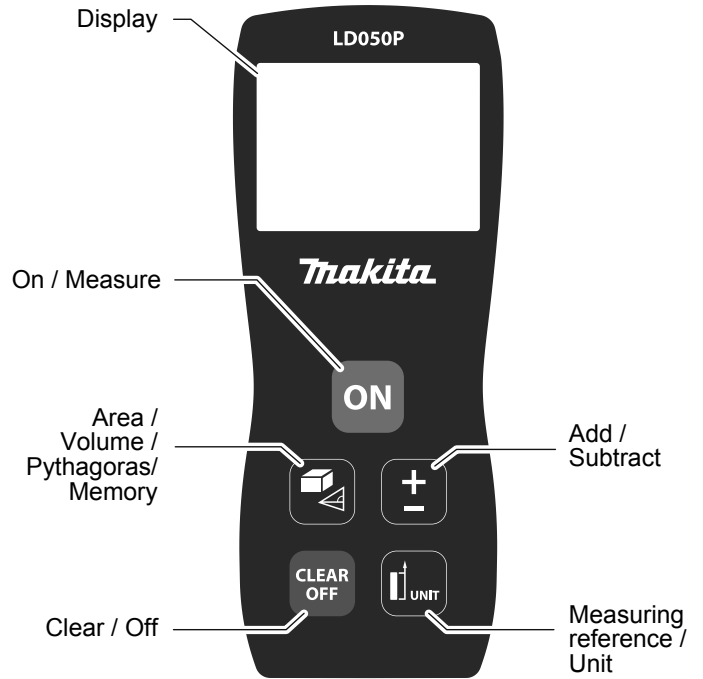

Instrument Set-up Display

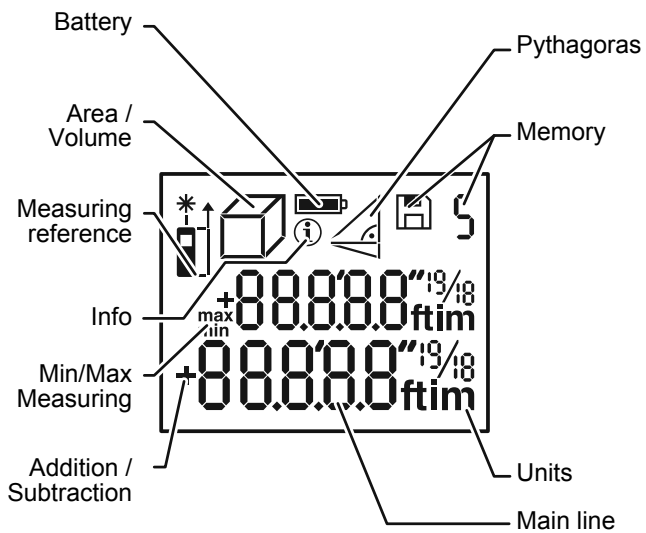

Insert batteries

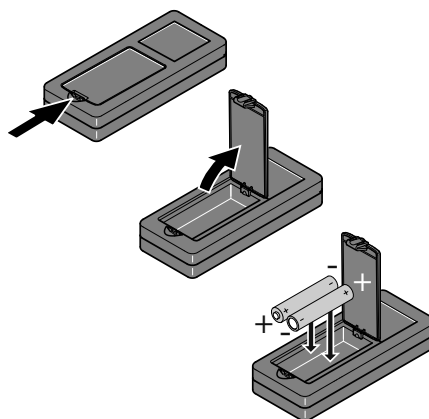

i

To ensure a reliable use, do not use zinc-carbon batteries. Change batteries when battery symbol is flashing.

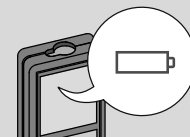

Operations

Switching ON/OFF

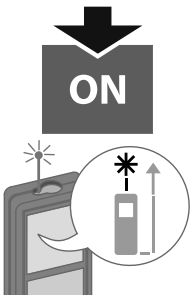

Clear



Undo last action.

Message Codes

If the info icon appears with a number, observe the instructions in section "Message Codes". Example:



Adjusting measuring reference

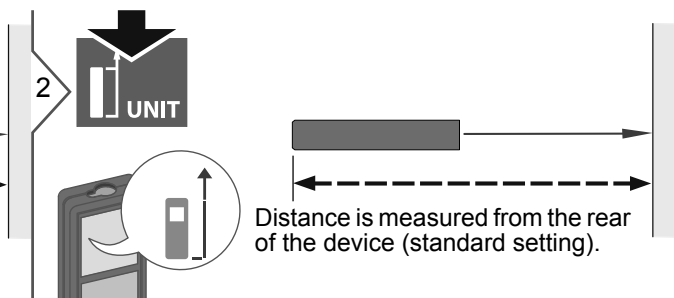
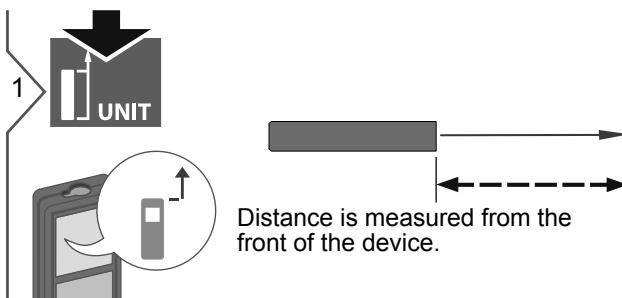

Distance unit setting



Switch between the following units:

0.000m	0'00" 1/16
0.00m	0.00in
0.00ft	0 1/16in

Measuring Functions

Measuring single distance

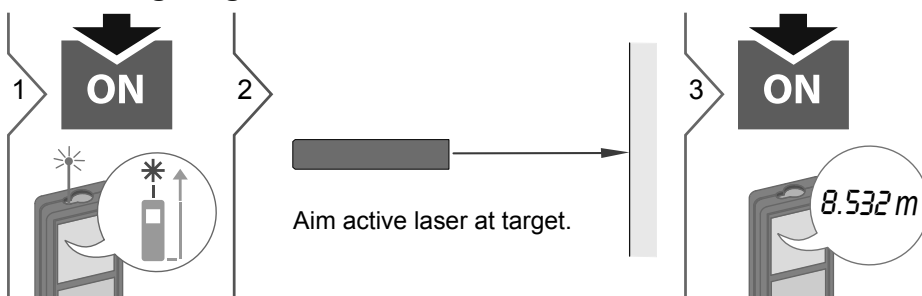

i Target surfaces: Measuring errors can occur when measuring to colourless liquids, glass, styrofoam or semi-permeable surfaces or when aiming at high gloss surfaces. Against dark surfaces the measuring time increases.

Permanent measuring

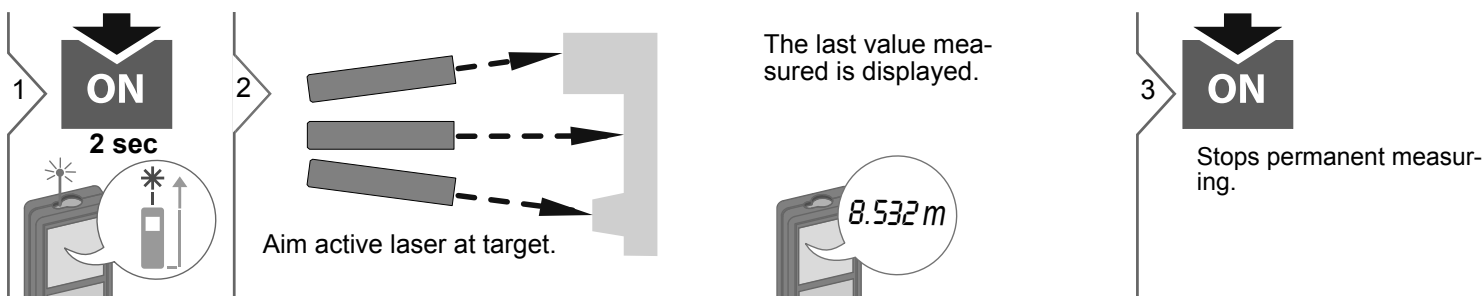

Add / Subtract

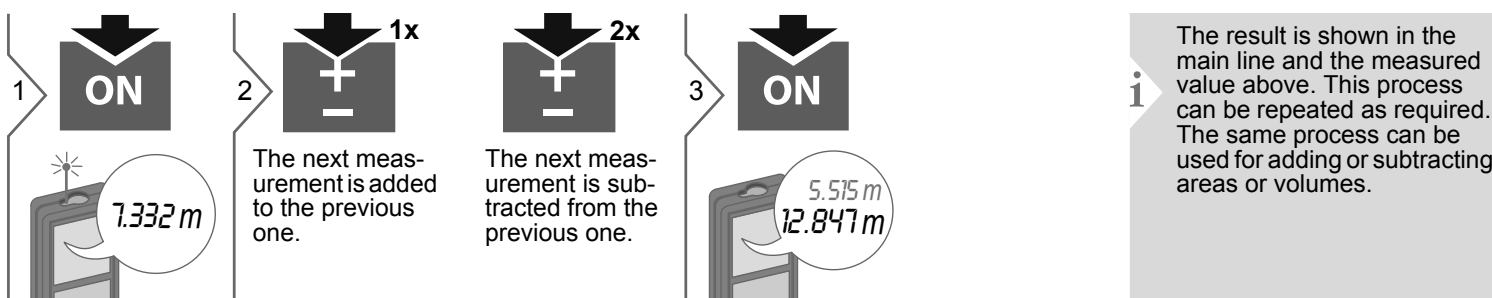

Makita LD050P

en **Measuring Functions**

Area

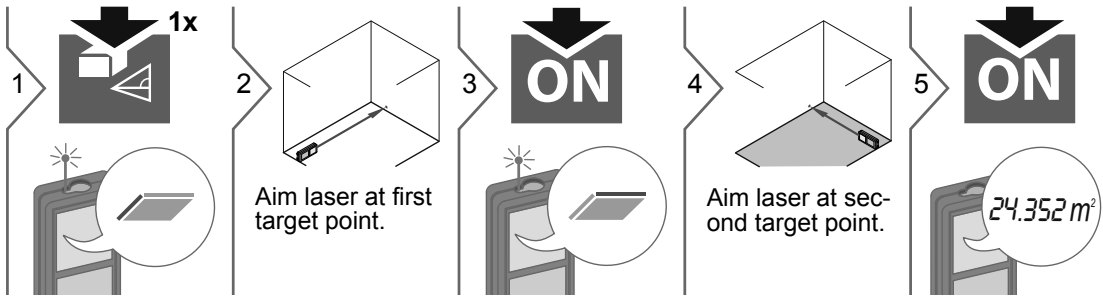

i The result is shown in the main line and the measured value above.

Volume

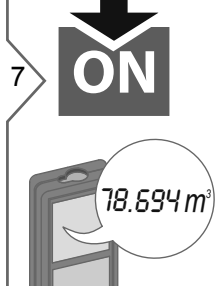
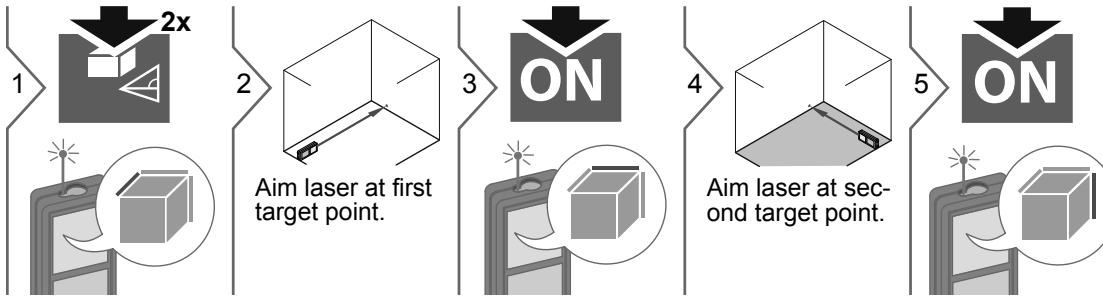

i The result is shown in the main line and the measured value above.

Measuring Functions

Pythagoras (2-point)

1 **3x**

2 Aim laser at upper point.

3 **ON**

4 Aim laser rectangular at lower point.

5 **ON** 8.294 m

i The result is shown in the main line and the measured distance above. Pressing the measuring key for 2 sec in the function activates automatically Minimum or Maximum measurement.

Pythagoras (3-point)

1 **4x**

2 Aim laser at upper point.

3 **ON**

4 Aim laser at rectangular point.

5 **ON**

6 Aim laser at lower point.

7 **ON** 8.294 m

i The result is shown in the main line and the measured distance above. Pressing the measuring key for 2 sec in the function activates automatically Minimum or Maximum measurement.

Measuring Functions Memory (5 last results)

1

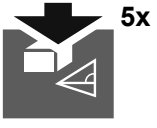

5 last results are displayed.



2



Navigates through 5 last results.



Technical Data

Distance measurement	(ISO 16331-1)
Accuracy with favourable conditions *	± 2.0 mm / 0.08 in ***
Accuracy with unfavourable conditions **	± 3.0 mm / 0.12 in ***
Range with favourable conditions *	50 m / 164 ft
Range with unfavourable conditions **	35 m / 115 ft
Smallest unit displayed	1 mm / 1/16 in
Ø laser point at distances	6 / 30 mm (10 / 50 m)
General	
Laser class	2
Laser type	635 nm, < 1 mW
Protection class	IP54 (dust- and splash water protected)
Autom. laser switch off	after 90 s
Autom. power switch-off	after 180 s
Battery durability (2 x AAA)	up to 5000 measurements
Dimension (H x D x W)	116 x 45 x 29 mm 4.57 x 1.77 x 1.14 in
Weight (with batteries)	0.10 kg / 3.527 oz
Temperature range:	
- Storage	-25 to 70 °C -13 to 158 °F
- Operation	0 to 40 °C 32 to 104 °F

* favourable conditions are: white and diffuse reflecting target (white painted wall), low background illumination and moderate temperatures.

** unfavourable conditions are: targets with lower or higher reflectivity or high background illumination or temperatures at the upper or lower end of the specified temperature range.

*** Tolerances apply from 0.05 m to 10 m with a confidence level of 95%.

With favourable conditions the tolerance may deteriorate by 0.10 mm/m for distances between 10 m to 30 m and by 0.15 mm/m for distances above 30 m.

With unfavourable conditions the tolerance may deteriorate by 0.15 mm/m for distances between 10 m to 30 m and by 0.20 mm/m for distances above 30 m.

Functions	
Distance measuring	yes
Min/Max measuring	yes
Permanent measuring	yes
Addition/Subtraction	yes
Area	yes
Volume	yes
Pythagoras	2-point, 3-point
Memory	5 results

Message Codes

If the message **Error** does not disappear after switching on the device repeatedly, contact the dealer.

If the message **InFo** appears with a number, press the Clear button and observe the following instructions:

No.	Cause	Correction
204	Calculation error	Perform measurement again.
252	Temperature too high	Let device cool down.
253	Temperature too low	Warm device up.
255	Received signal too weak, measuring time too long	Change target surface (e.g. white paper).
256	Received signal too high	Change target surface (e.g. white paper).
257	Too much background light	Shadow target area.
258	Measurement outside of measuring range	Correct range.
260	Laser beam interrupted	Repeat measurement.

Care

- Clean the device with a damp, soft cloth.
- Never immerse the device in water.
- Never use aggressive cleaning agents or solvents.

Safety Instructions

The person responsible for the instrument must ensure that all users understand these directions and adhere to them.

Areas of responsibility

Responsibilities of the manufacturer of the original equipment:

Makita Corporation Anjo,
Aichi 446-8502 Japan /
Makita, Jan-Baptist Vinkstraat 2, 3070,
Belgium

Internet: www.makita.com

The company above is responsible for supplying the product, including the User Manual in a completely safe condition.

The company above is not responsible for third party accessories.

Responsibilities of the person in charge of the instrument:

- To understand the safety instructions on the product and the instructions in the User Manual.
- To be familiar with local safety regulations relating to accident prevention.
- Always prevent access to the product by unauthorised personnel.

Safety Instructions

Permitted use

- Measuring distances
- Tilt measurement

Prohibited use

- Using the product without instruction
- Using outside the stated limits
- Deactivation of safety systems and removal of explanatory and hazard labels
- Opening of the equipment by using tools (screwdrivers, etc.)
- Carrying out modification or conversion of the product
- Use of accessories from other manufacturers without express approval
- Deliberate dazzling of third parties; also in the dark
- Inadequate safeguards at the surveying site (e.g. when measuring on roads, construction sites, etc.)
- Deliberate or irresponsible behaviour on scaffolding, when using ladders, when measuring near machines which are running or near parts of machines or installations which are unprotected
- Aiming directly in the sun

Hazards in use

WARNING

Watch out for erroneous measurements if the instrument is defective or if it has been dropped or has been misused or modified. Carry out periodic test measurements. Particularly after the instrument has been subject to abnormal use, and before, during and after important measurements.



CAUTION

Never attempt to repair the product yourself. In case of damage, contact a local dealer.

WARNING

Changes or modifications not expressly approved could void the user's authority to operate the equipment.

Limits of use

-  Refer to section "Technical data".
-  The device is designed for use in areas permanently habitable by humans. Do not use the product in explosion hazardous areas or in aggressive environments.

Disposal

CAUTION

Flat batteries must not be disposed of with household waste. Care for the environment and take them to the collection points provided in accordance with national or local regulations.

The product must not be disposed with household waste.

Dispose of the product appropriately in accordance with the national regulations in force in your country.

Adhere to the national and country specific regulations.

Product specific treatment and waste management can be downloaded from our homepage.



Electromagnetic Compatibility (EMC)

WARNING

The device conforms to the most stringent requirements of the relevant standards and regulations.

Yet, the possibility of causing interference in other devices cannot be totally excluded.

Safety Instructions

FCC statement (applicable in U.S.)

This equipment has been tested and found to comply with the limits for a Class B digital device, pursuant to part 15 of the FCC Rules. These limits are designed to provide reasonable protection against harmful interference in a residential installation. This equipment generates, uses and can radiate radio frequency energy and, if not installed and used in accordance with the instructions, may cause harmful interference to radio communications.

However, there is no guarantee that interference will not occur in a particular installation. If this equipment does cause harmful interference to radio or television reception, which can be determined by turning the equipment off and on, the user is encouraged to try to correct the interference by one or more of the following measures:

- Reorient or relocate the receiving antenna.
- Increase the separation between the equipment and receiver.
- Connect the equipment into an outlet on a circuit different from that to which the receiver is connected.
- Consult the dealer or an experienced radio/TV technician for help.

Laser classification

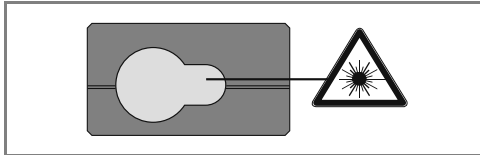

The device produces visible laser beams, which are emitted from the instrument. It is a Class 2 laser product in accordance with:

- IEC60825-1 : 2014 „Radiation safety of laser products“

Laser Class 2 products:

Do not stare into the laser beam or direct it towards other people unnecessarily. Eye protection is normally afforded by aversion responses including the blink reflex.

⚠ WARNING

Looking directly into the beam with optical aids (e.g. binoculars, telescopes) can be hazardous.

⚠ CAUTION

Looking into the laser beam may be hazardous to the eyes.

Description	Value
Maximum peak radiant output power	0.95 mW
Wavelength	635 nm
Pulse duration	> 400 ps
Pulse repetition frequency	320 MHz
Beam divergence	0.16 x 0.6 mrad

Labelling

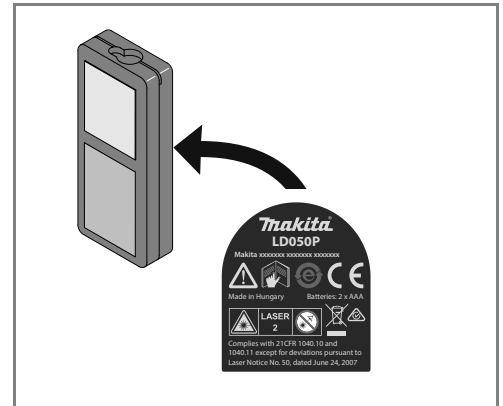

Subject to change (drawings, descriptions and technical data) without prior notice.