



VN	VIETNAM
----	---------

Diagram / Parts List

GA9030

ANGLE GRINDER 230MM



(VN) GA9030 / ANGLE GRINDER 230MM

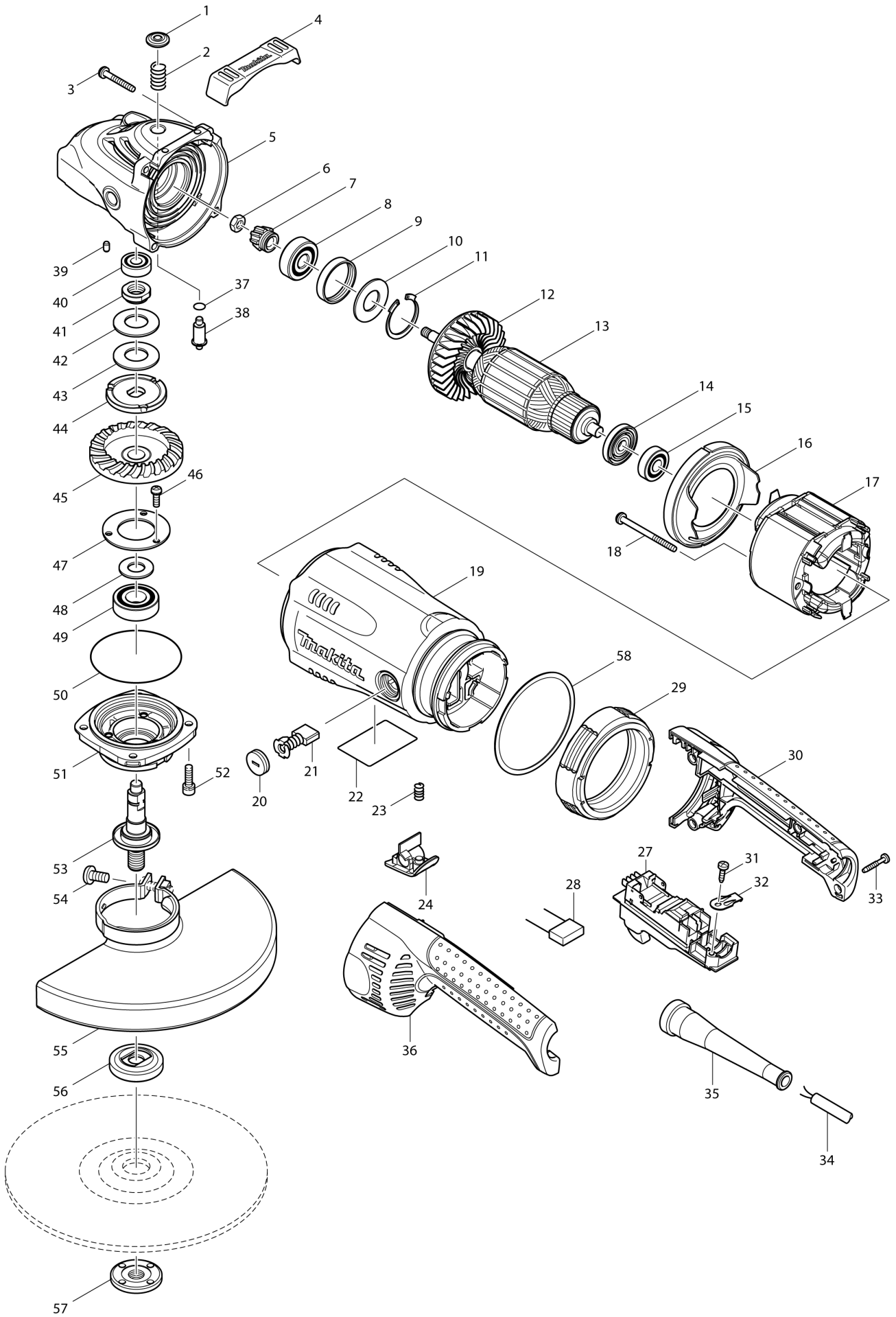

VN	VIETNAM
-----------	----------------

GA9030 / ANGLE GRINDER 230MM

Item	Sub	Parts No.	Parts Description	Qty	I/C	E/C No.	Close No.	Remark
001		419133-4	PIN CAP	1				
002		233292-8	COMPRESSION SPRING 12	1				
003		266012-5	TAPPING SCREW 5X35	4				
004		419144-9	BUMPER	1				
005		154685-5	GEAR HOUSING COMPLETE	1			Y05292	
	C10	262118-7	FELT RING 18	1			Y05292	
005-1		154685-5	GEAR HOUSING COMPLETE	1	O	Y05292	Y05442	
	C10	262118-7	FELT RING 18	1		Y05292	Y05442	
	C20	419134-2	LABYRINTH PLATE	1		Y05292	Y05442	
005-2		154685-5	GEAR HOUSING COMPLETE	1	O	Y05442	A7692	
	C10	262118-7	FELT RING 18	1		Y05442	A7692	
005-3		142754-4	GEAR HOUSING COMPLETE	1	<	A7692		
	C10	262118-7	FELT RING 18	1		A7692		
006		252194-9	HEX. NUT M8	1				
007		227490-4	SPIRAL BEVEL GEAR 12	1				
008		211132-0	BALL BEARING 6301DDW	1				
009		262085-6	RUBBER RING 38	1				
010		267299-2	FLAT WASHER 20	1				
011		962211-4	RETAINING RING R-42	1				
012		240081-4	FAN 80	1				
013		516963-5	ARMATURE ASS'Y 220V	1			83838	
	D10		INC. 12,14,15				83838	
013-1		517828-4	ARMATURE ASS'Y 220V	1	<	83838		
	D10		INC. 12,14,15			83838		
014		681630-2	INSULATION WASHER	1				
015-1		211087-9	BALL BEARING 6200DDW	1				
016		419135-0	BAFFLE PLATE	1				
017		526168-9	FIELD ASS'Y 220V	1			83650	
	C10	654197-3	RING TERMINAL	2			83650	
	C20	654502-4	CONNECTOR P-2	2			83650	
017-1		526193-0	FIELD ASS'Y 220-240V	1	O	83650		
	C10	654197-3	RING TERMINAL	2		83650		
	C20	654502-4	CONNECTOR P-2	2		83650		
018		266029-8	TAPPING SCREW 5X65	2				
019		154786-9	MOTOR HOUSING COMPLETE	1				
	C10	643712-8	BRUSH HOLDER	2				
020		643700-5	BRUSH HOLDER CAP 7-18	2				
021		A-81337	CARBON BRUSH CB-204A	1			83185	
021-1		B-80145	CARBON BRUSH SET CB-204A	1	O	83185	85070	
021-2		B-80357	CARBON BRUSH SET CB-204A	1	<	85070		
022		862125-6	GA9030 NAME PLATE	1				
023		233375-4	COMPRESSION SPRING 7	1				
024		419260-7	LOCK BUTTON	1				
027		651176-2	SWITCH 1267.4109	1			82694	
027-1		650101-0	SWITCH TG08-1100-011	1	O	82694		
029		421936-4	VIBRATION PROOF RUBBER	1				
030		188123-5	HANDLE SET	1				
	C10	423350-0	SPONGE SHEET	1				
	D10		INC. 36					
031		266192-7	TAPPING SCREW 4X14	1				
032		687169-3	STRAIN RELIEF	1				
033		265999-8	TAPPING SCREW 4X25	4				
034		665630-0	POWER SUPPLY CORD 1.5-2-2.5	1			89426	
034-1		695107-1	POWER SUPPLY CORD 1.5-2-2.5	1	O	89426		
035		682560-0	CORD GUARD 10	1				
036		188123-5	HANDLE SET	1				
	C10	423350-0	SPONGE SHEET	1				
	D10		INC. 30					
037		213062-1	O RING 9	1				
038		256491-5	SHOULDER PIN 5	1				
039		263002-9	RUBBER PIN 4	1				
040-1		211061-7	BALL BEARING 6000LLB	1				
041		252429-8	NUT M15-23	1				
042		232163-6	CUP SPRING 20	1				
043		232163-6	CUP SPRING 20	1				

Interchange
O : Yes
X : No
< : the new part can be substituted for the current.
> : the current part can be substituted for the new.
S : Interchangeable as a set.

