



VN	VIETNAM
----	---------

Diagram / Parts List

DUH604S

600MM CORDLESS HEDGE TRIMMER

(VN) DUH604S / 600MM CORDLESS HEDGE TRIMMER

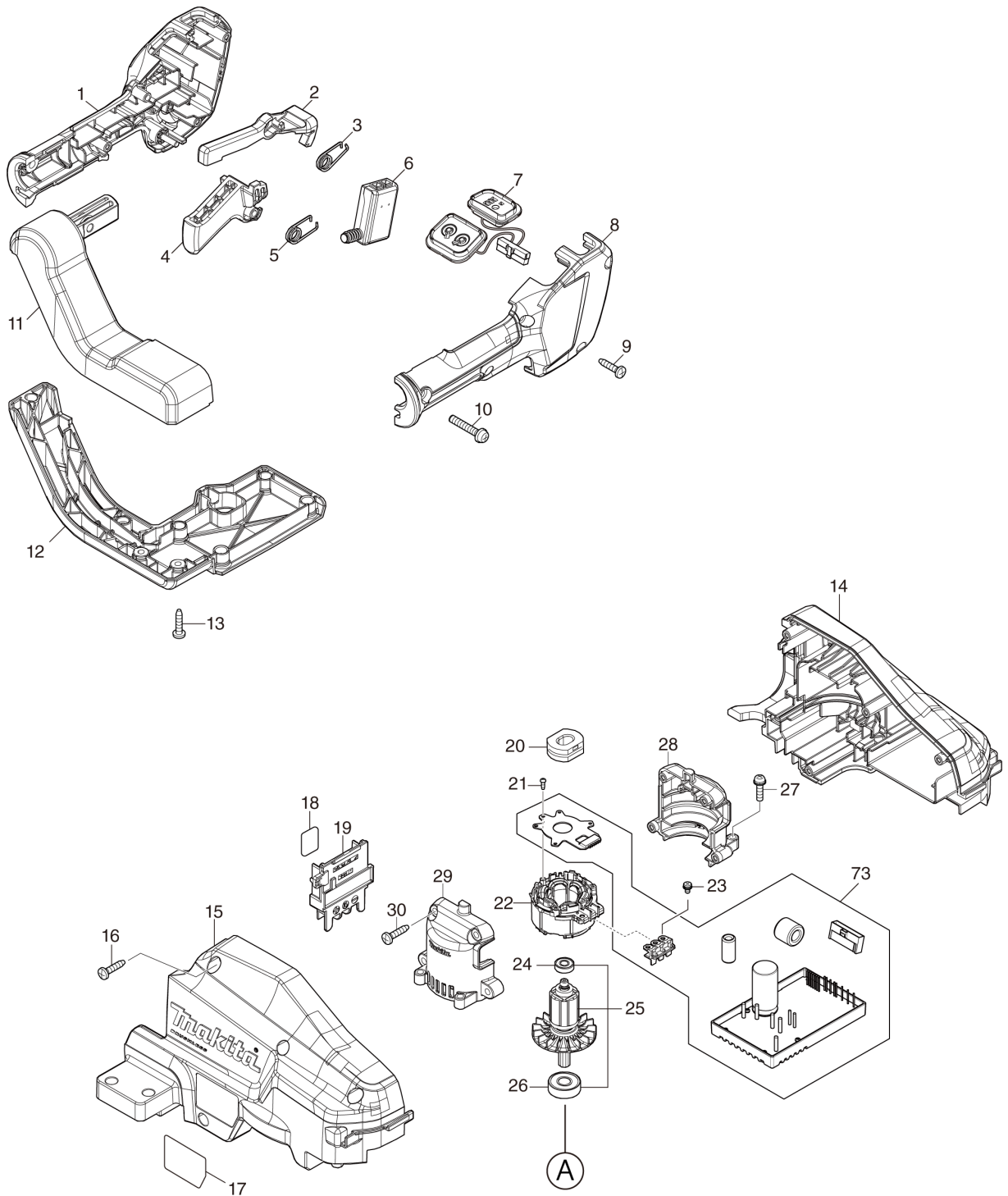

(VN) DUH604S / 600MM CORDLESS HEDGE TRIMMER

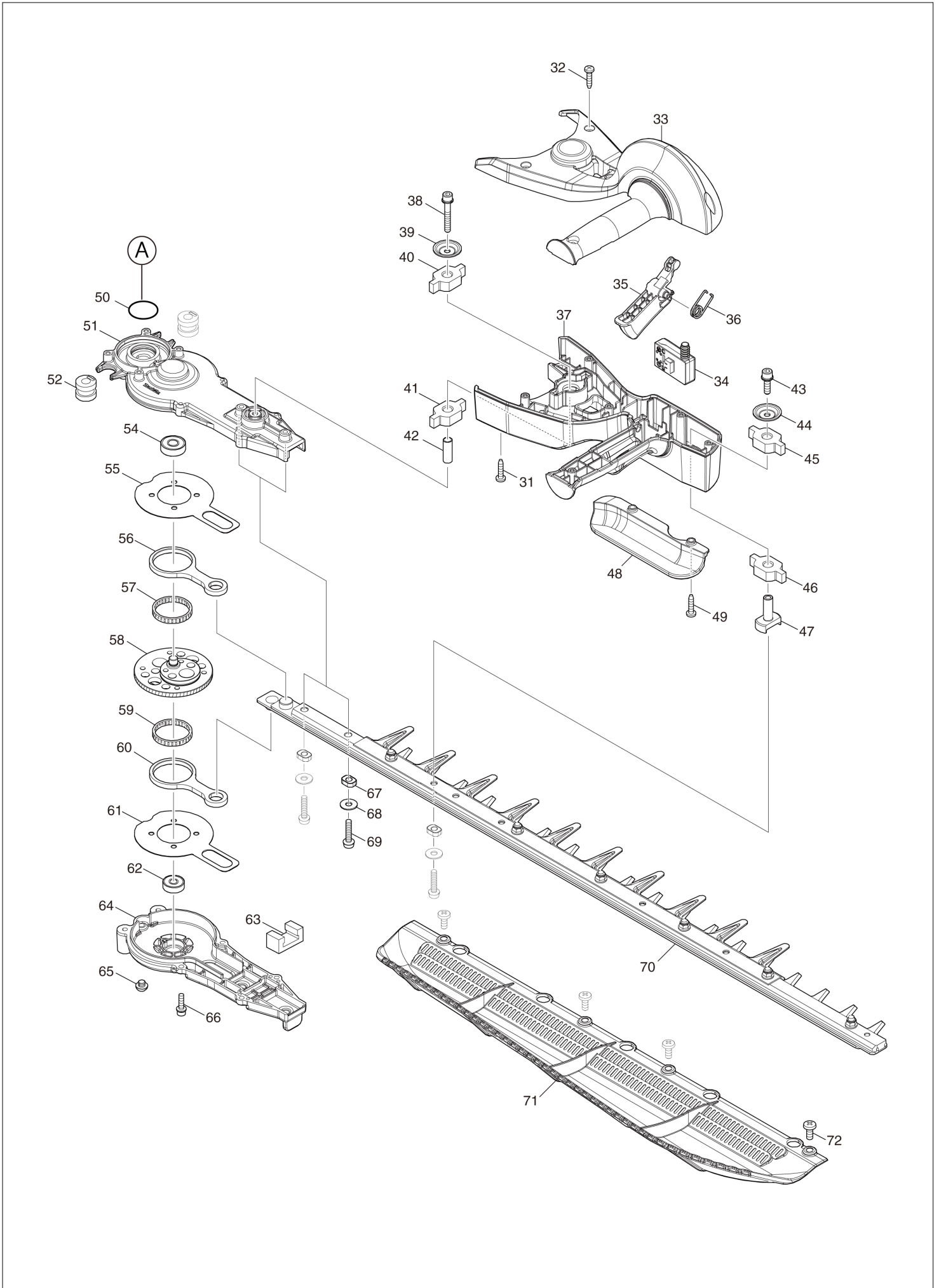

VN	VIETNAM
-----------	----------------

DUH604S / 600MM CORDLESS HEDGE TRIMMER

Item	Sub	Parts No.	Parts Description	Qty	I/C	E/C No.	Close No.	Remark
001		183N66-0	GRIP SET	1				
	C10	252180-0	HEX. LOCK NUT M5-8	1				
	D10		INC. 8					
002		455629-1	LOCK OFF LEVER	1				
003		233621-5	TORSION SPRING 9	1				
004		412315-7	SWITCH LEVER R	1				
005		233621-5	TORSION SPRING 9	1				
006		651083-9	SWITCH C3XA-1PSPM	1				
007		140S92-2	SUB CONTROLLER COMPLETE	1				
	C10	8008M5-7	SWITCH LABEL	1				
	C20	8008M7-3	INDICATION LABEL	1				
008		183N66-0	GRIP SET	1				
	C10	252180-0	HEX. LOCK NUT M5-8	1				
	D10		INC. 1					
009		266326-2	TAPPING SCREW 4X18	4				
010		911253-5	PAN HEAD SCREW M5X30	1				
011		412311-5	GRIP JOINT COVER	1				
012		412310-7	GRIP JOINT	1				
013		266326-2	TAPPING SCREW 4X18	8				
014		183N69-4	HOUSING SET	1				
	C10	263005-3	RUBBER PIN 6	2				
	C20	424344-8	DAMPER	4				
	D10		INC. 15					
015		183N69-4	HOUSING SET	1				
	C10	263005-3	RUBBER PIN 6	2				
	C20	424344-8	DAMPER	4				
	D10		INC. 14					
016		266326-2	TAPPING SCREW 4X18	4				
017		856R28-2	DUH604S NAME PLATE	1				
018		856R31-3	DUH604S SERIAL NO. LABEL	1				
019		643874-2	TERMINAL	1				
020		422261-6	RUBBER SLEEVE	1				
021		266490-9	TAPPING SCREW PT 2X6	3				
022		629352-6	STATOR	1				
023		652069-6	FLAT HEAD SCREW M3X6	3				
024		211157-4	BALL BEARING 695ZZ	1				
025		510448-3	ROTOR ASSY	1				
	D10		INC. 24,26					
026		210005-4	BALL BEARING 608DDW	1				
027		911128-8	P.H.SCREW M4X16 WITH WR	4				
028		183L66-8	MOTOR HOUSING SET	1				
	D10		INC. 29					
029		183L66-8	MOTOR HOUSING SET	1				
	D10		INC. 28					
030		266326-2	TAPPING SCREW 4X18	4				
031		266326-2	TAPPING SCREW 4X18	4				
032		266326-2	TAPPING SCREW 4X18	6				
033		183P30-3	FRONT GRIP SET	1				
	C10	8008M9-9	CAUTION LABEL	1				
	D10		INC. 37					
034		651083-9	SWITCH C3XA-1PSPM	1				
035		412316-5	SWITCH LEVER F	1				
036		233621-5	TORSION SPRING 9	1				
037		183P30-3	FRONT GRIP SET	1				
	C10	8008M9-9	CAUTION LABEL	1				
	D10		INC. 33					
038		251476-6	H.S.H.BOLT M5X35 WITH WR	1				
039		253416-0	DISH WASHER 5	1				
040		422260-8	RUBBER SLEEVE 8	1				
041		422260-8	RUBBER SLEEVE 8	1				
042		257678-2	SLEEVE 6	1				
043		922228-9	H.S.H.BOLT M5X18 WITH WR	1				
044		253416-0	DISH WASHER 5	1				
045		422260-8	RUBBER SLEEVE 8	1				
046		422260-8	RUBBER SLEEVE 8	1				

B:DUH604SRT(H)
C:DUH604SRGE(H)

Interchange
O : Yes
X : No
< : the new part can be substituted for the current.
> : the current part can be substituted for the new.
S : Interchangeable as a set.

