

# MULTICHANNEL ANEMOMASTER

SYSTEM 6 2 4 2 / 6 2 4 3  
(MODEL 1550) (MODEL 1560)

## INSTRUCTION MANUAL

We thank you very much for purchasing our Multichannel Anemomaster. This manual describes the operating procedure of the Anemomaster System 6242 & 6243. It is therefore suggested to read it carefully for proper and full use of the systems, and store it along with them.

CHAPTER 1	PRIOR TO USING THE ANEMOMASTER
CHAPTER 2	PREPARING FOR USE
CHAPTER 3	PRINTING DATA
CHAPTER 4	RS-232C DATA TRANSFER
CHAPTER 5	OPTIONS
CHAPTER 6	OTHERS

KANOMAX JAPAN INC.

# TABLE OF CONTENTS

## CHAPTER 1    PRIOR TO USING THE ANEMOMASTER

PARTS NAME AND FUNCTION .....	2
EVER TAKE THE FOLLOWING ACTIONS ! .....	4

## CHAPTER 2    PREPARING FOR USE

CHECKING THE SYSTEM CONFIGURATION .....	6
EXPLANATION ABOUT THE MODULES .....	7
MOUNTING A CHARACTERISTIC ROM .....	8
ADDRESSING THE MODULES .....	9
MOUNTING THE MODULES IN THE SYSTEM .....	10
CONNECTING A PROBE TO THE SYSTEM .....	11
NOTE OF THE PROBE NO. AND .....	13
THE MODULE NO.	
DESCRIPTION OF THE DISPLAY ITEMS .....	15

## CHAPTER 3    PRINTING DATA

PRINTING DATA .....	20
Connecting a printer cable .....	20
Connector pin allocation .....	20
Operation method .....	21
Examples of the printing data .....	22
PRINTING PRECAUTIONS .....	23
Data overflow .....	23
Others .....	23



## CHAPTER 4    RS-232C DATA TRANSFER

OVERVIEW OF DATA TRANSFER .....	26
OUTPUT CONNECTOR .....	27
CHECKING THE OUTPUT FORMAT .....	28
DESCRIPTION OF MEASUREMENT MODES .....	29
(BURST MODE AND CHANNEL MODE )	
OUTPUT FORMAT (1) BURST MODE .....	31
OUTPUT FORMAT (2) CHANNEL MODE .....	33
TIMING CHART FOR DATA READING .....	34
DESCRIPTION ON COMMANDS .....	36
SETTING THE DELIMITER ( CR, CR/LF) .....	40
ERROR FLAG (RETURN CODE) .....	41
COMMAND INPUT PROCEDURE .....	42
EXAMPLE OF PROGRAM TO TAKE DATA .....	43

## CHAPTER 5    OPTIONS

ANALOG OUTPUT .....	46
CASCADE CONNECTION(Extended RS-232C) .....	50
GP-IB INTERFACE .....	51

## CHAPTER 6    OTHERS

SYSTEM SPECIFICATIONS .....	58
PROBE SPECIFICATIONS .....	60
TROUBLESHOOTING .....	61
WARRANTY AND AFTER-SALE .....	62
SERVICE OF PRODUCT	



# TABLE OF CONTENTS-CHAPTER 1

PRIOR TO USING THE ANEMOMASTER

- ◆ PARTS NAME AND FUNCTION ..... 2
- ◆ NEVER TAKE THE FOLLOWING ACTIONS ! ..... 4

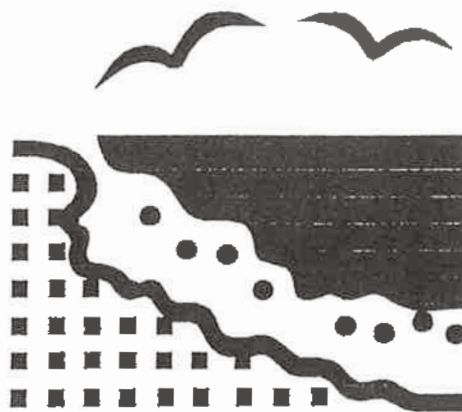

# PARTS NAME AND FUNCTION

## [An Example of Display]

The module v displays all data of 4 channels simultaneously.

### Display Section

Data is displayed on a module basis. In the AUTO mode, the screen automatically changes every 2 seconds.

Module NO.	(M-01)	[V]	Module Name
V1	12.5	m/s	[V] : Air velocity
V2	13.6	m/s	[VT] : Air velocity and temperature
V3	12.9	m/s	[VTH] : Air velocity, temperature and relative humidity
V4	14.7	m/s	
	[AUTO]		

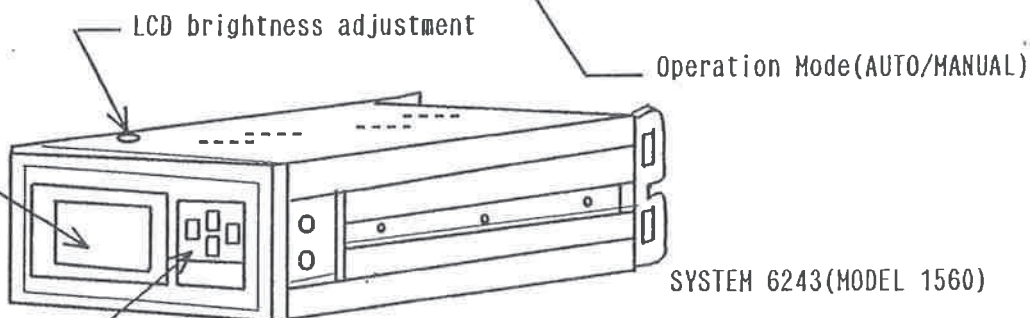

### Operation Section

AUTO	Automatically changes modules every 2 seconds to display data on the LCD screen.	
MANUAL	Operating the [UP] and [DOWN] KEYS ALLOWS module selection for display.	
MAN.	UP	Module NO. M- 1→2→3.....→8.....→16
	DOWN	Module NO. M- 16→...8.....→3→2→1
PRINT	Prints displayed data to externally connected printer every 2 seconds. AUTO : Automatically selected module MANUAL : Same module	

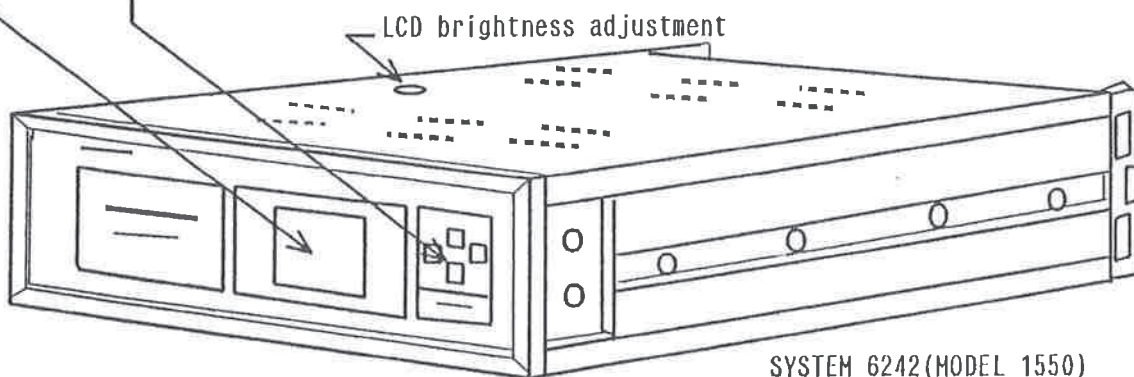

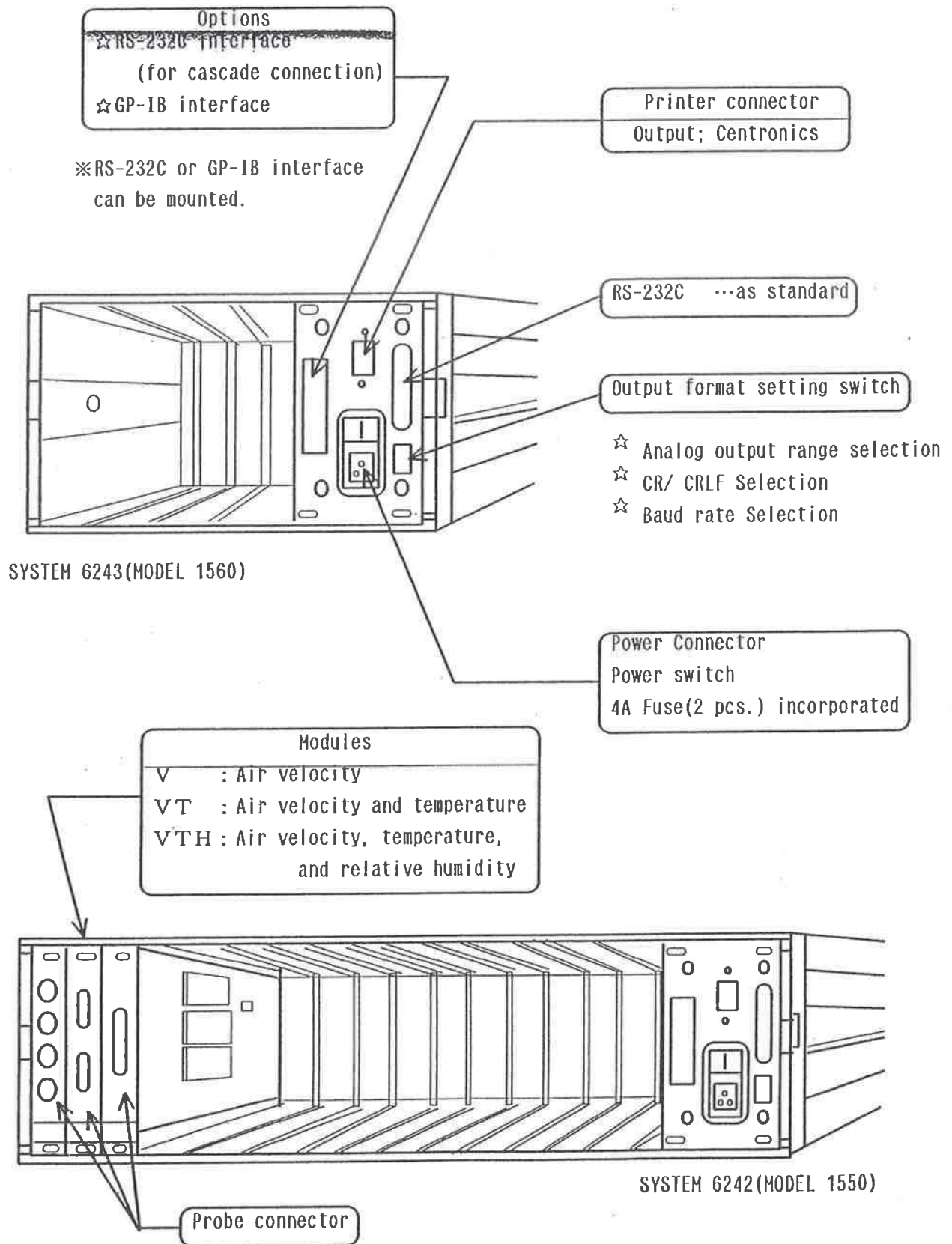



# NEVER TAKE THE FOLLOWING ACTIONS!

※ Take special care when connecting and disconnecting the probe.

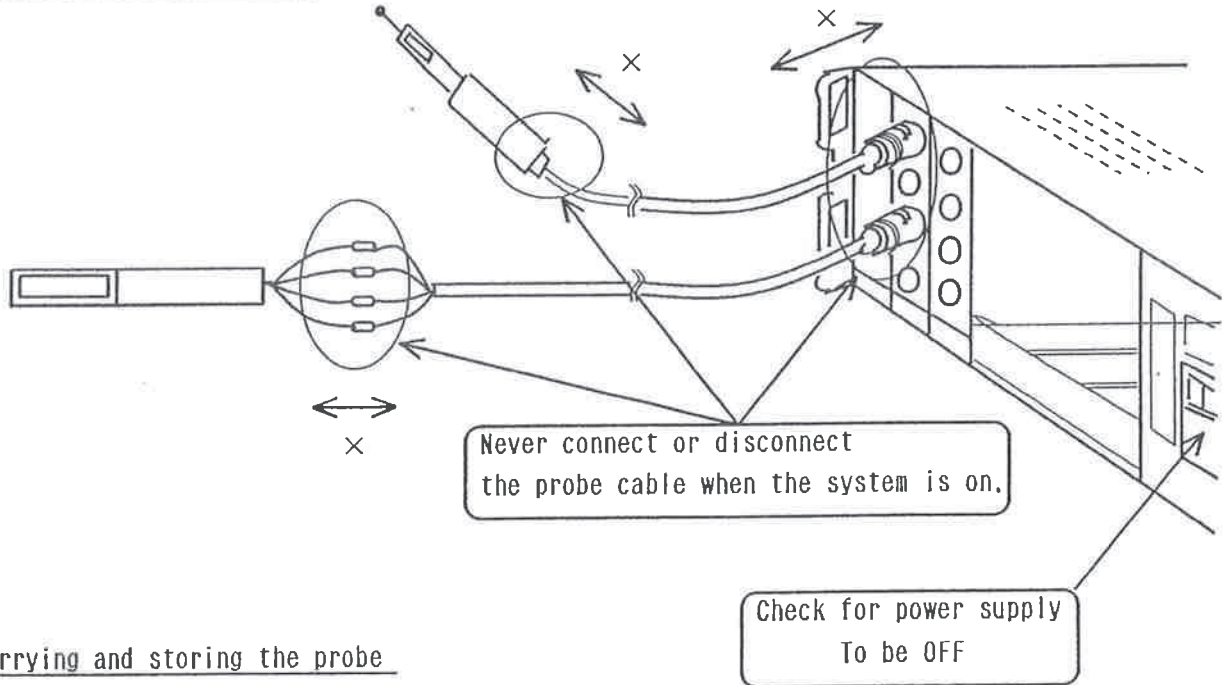

※ Carrying and storing the probe

"Be sure to use a protective cap."

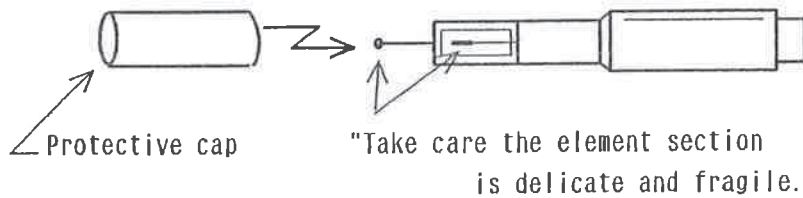

Bending the element section exerts an adverse effect on its characteristics. Take due care in handling it.



Do not touch the element section.

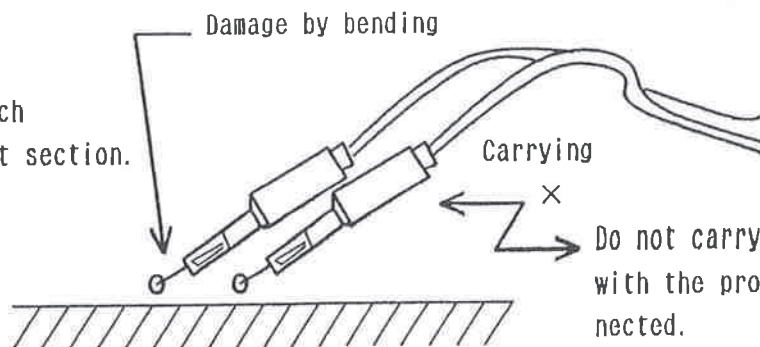

# TABLE OF CONTENTS-CHAPTER 2

## PREPARING FOR USE

◆ CHECKING THE SYSTEM CONFIGURATION	( STEP 1 )	.....	6
◆ EXPLANATION ABOUT THE MODULES	( STEP 2 )	.....	7
◆ MOUNTING A CHARACTERISTIC ROM	( STEP 3 )	.....	8
◆ ADDRESSING THE MODULES	( STEP 4 )	.....	9
◆ MOUNTING THE MODULES IN THE SYSTEM	( STEP 5 )	.....	1 0
◆ CONNECTING A PROBE TO THE SYSTEM	( STEP 6 )	.....	1 1
◆ NOTE OF THE PROBE NO. AND THE MODULE NO.	( STEP 7 )	.....	1 3
◆ DESCRIPTION OF THE DISPLAY ITEMS	( STEP 8 )	.....	1 5



### [1] Body

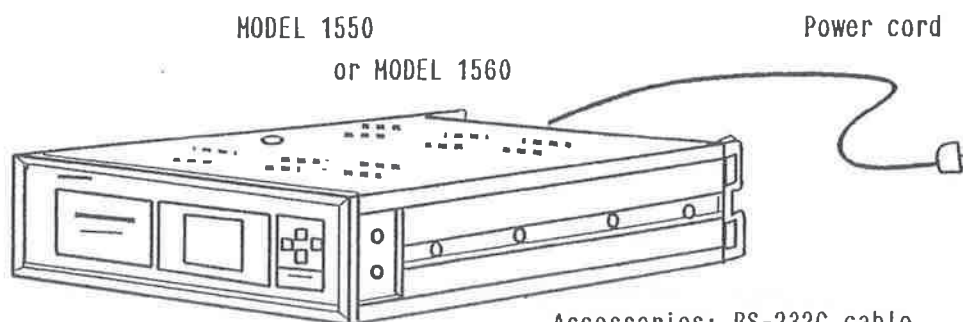

Accessories: RS-232C cable  
printer cable  
power cord  
& 2 fuses (4A)

### [2] Module

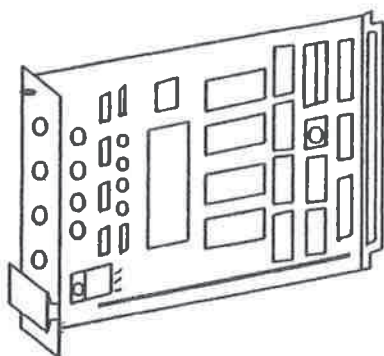

- ※ Check the module for a model NO.
- ☆ MODEL 1504 : 4 channels for air velocity
- ☆ MODEL 1511 : 2 channels each for air velocity and temperature
- ☆ MODEL 1512 : 1 channel each for air velocity, temperature and relative humidity

### [3] Probe Cable

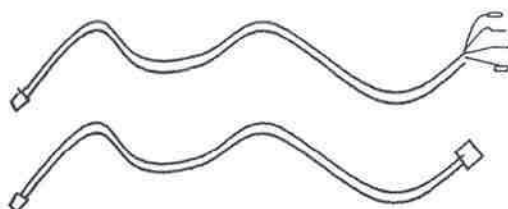

※ A probe cable to be used differs depending on probe type. So, check for the right cable.

### [4] Probe

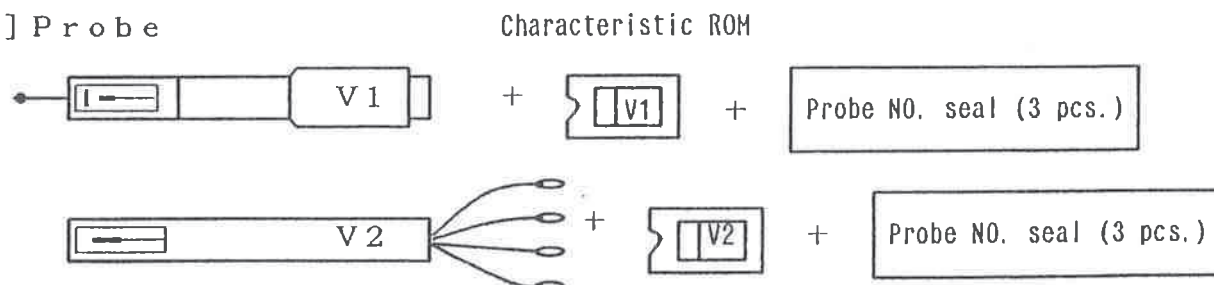

※ A probe and a ROM form a pair. Each Probe has different probe characteristics, and its characteristics data is written in the ROM. When mounting the ROM on the module, check the ROM for compatibility with the intended probe.

# EXPLANATION ABOUT THE MODULES

STEP 2

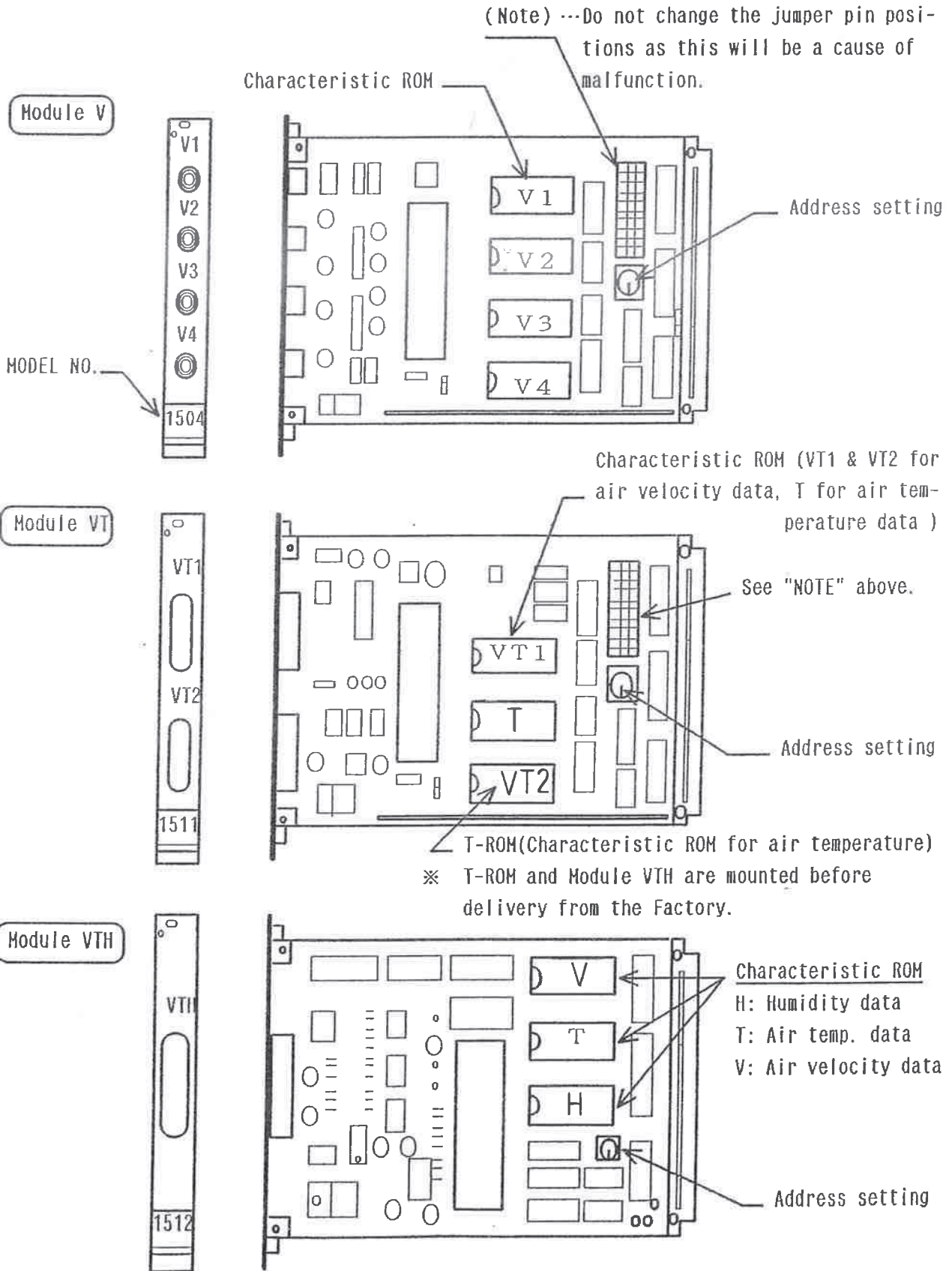

- ◆ Mount a characteristic ROM that is appropriate to the intended probe, in the correct position, in accordance with Step 2 of the previous page.

※ Take care of the ROM mounting orientation as wrong mounting may cause malfunction.  
 ※ Mount the ROM while taking care not to bend its legs.

[An Example: Module V]

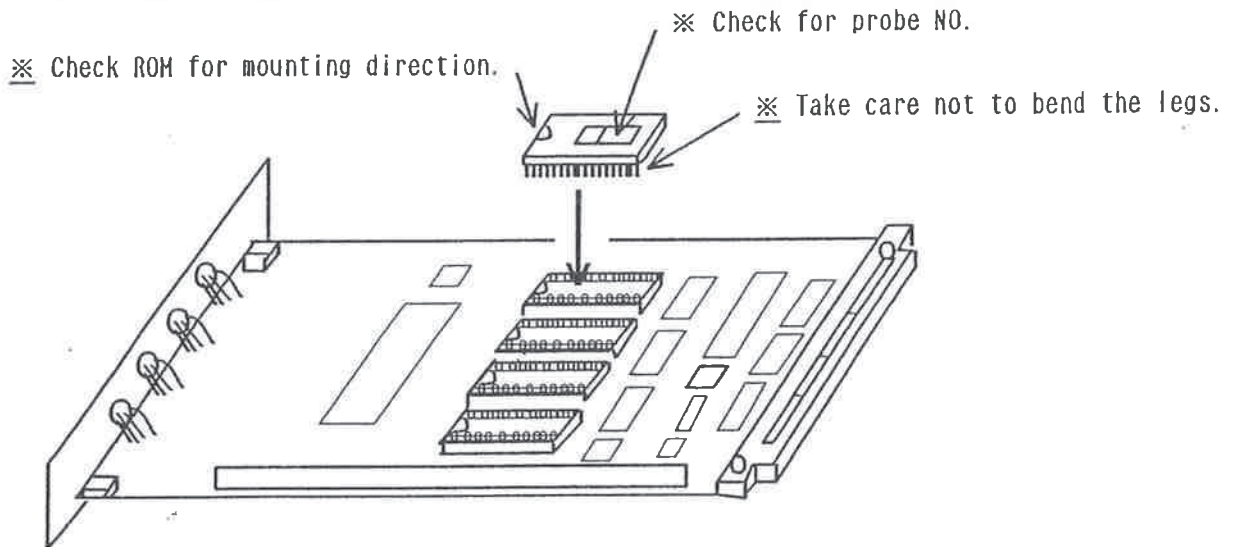

### Removing the characteristic ROM

- ◆ Press in a flat-bladed screwdriver between the ROM and the socket, and gradually lift the ROM from each side.
- ◆ Take special care not to lift the ROM unevenly as it may bend the ROM legs.
- ◆ Repeat the procedures (1) to (4) and gradually lift the ROM.

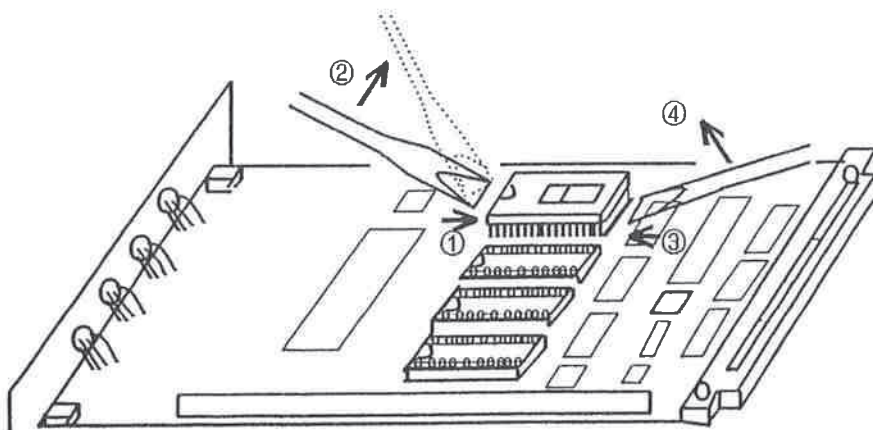

# ADDRESSING THE MODULES

STEP 4

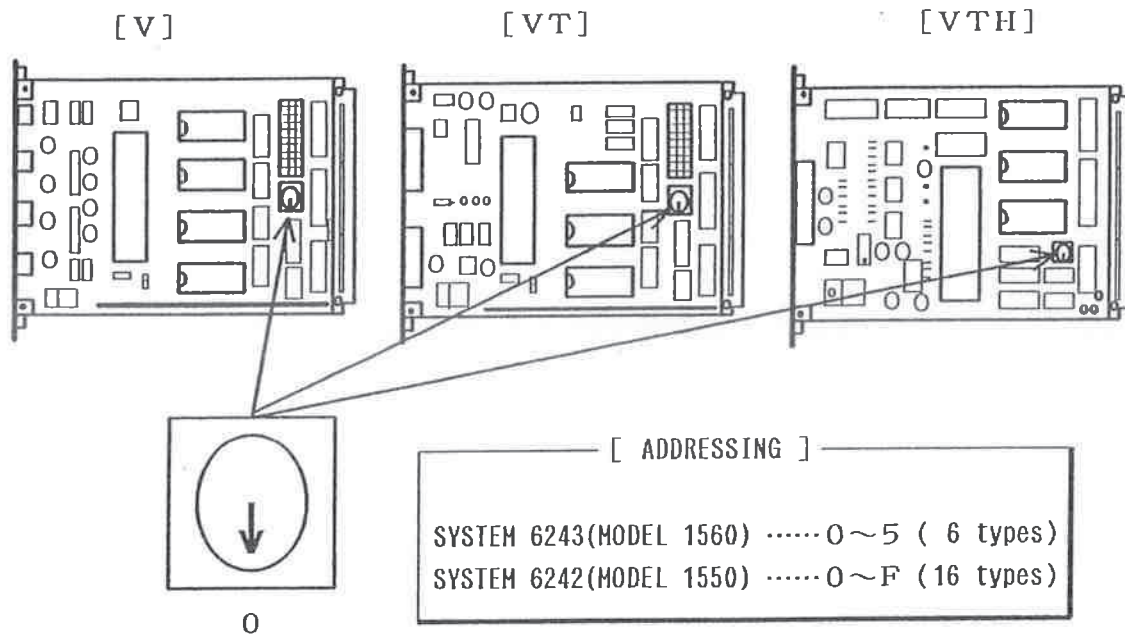

◆ Address each module as follows:

Take care not to use the same address as this will be a cause of malfunction.

Module NO. ...M-01 02 03 04 05 06

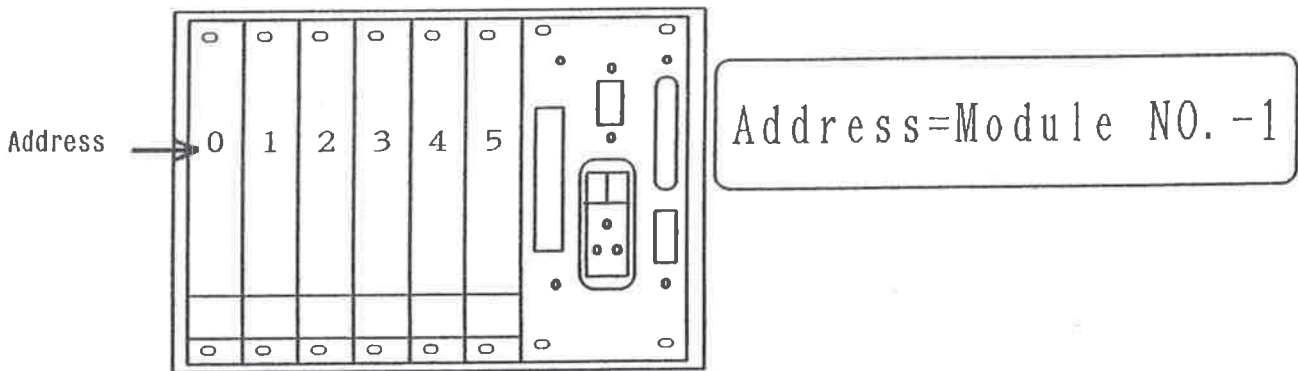

Module NO. ...M-01 02 03 04 05 06 07 08 09 10 11 12 13 14 15 16

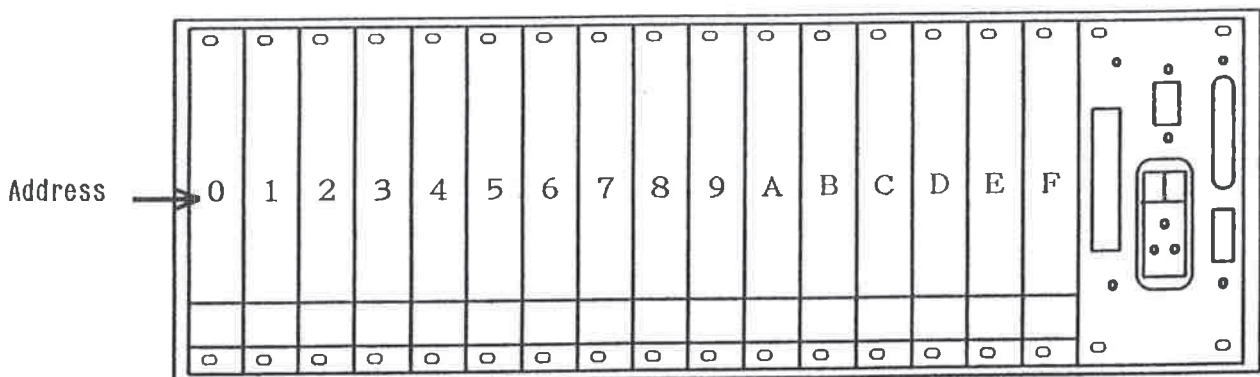

- ① Make sure that power is off.
- ② Insert the module along the guide rails and place it at the position addressed as per Step 4.
- ③ When the module has been properly positioned, secure it using a flat-bladed screwdriver.

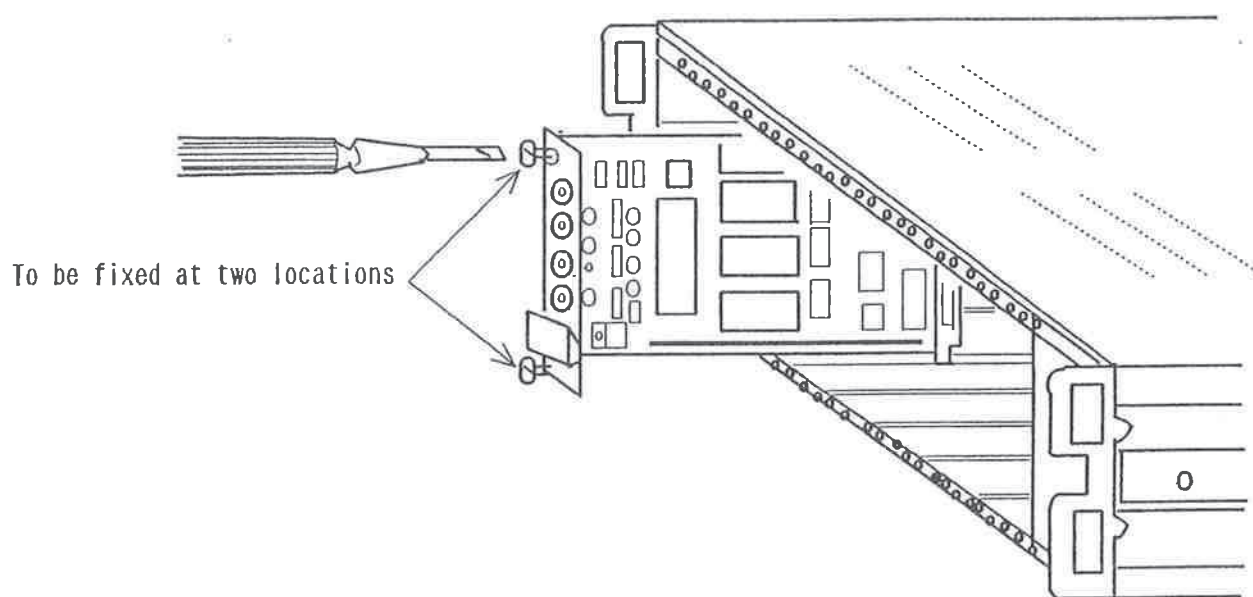

Memo



# CONNECTING A PROBE TO THE SYSTEM

STEP 6

Attach probe NO. seals.

Three probe NO. seals are provided for each probe. Use them at the positions illustrated in the figures.

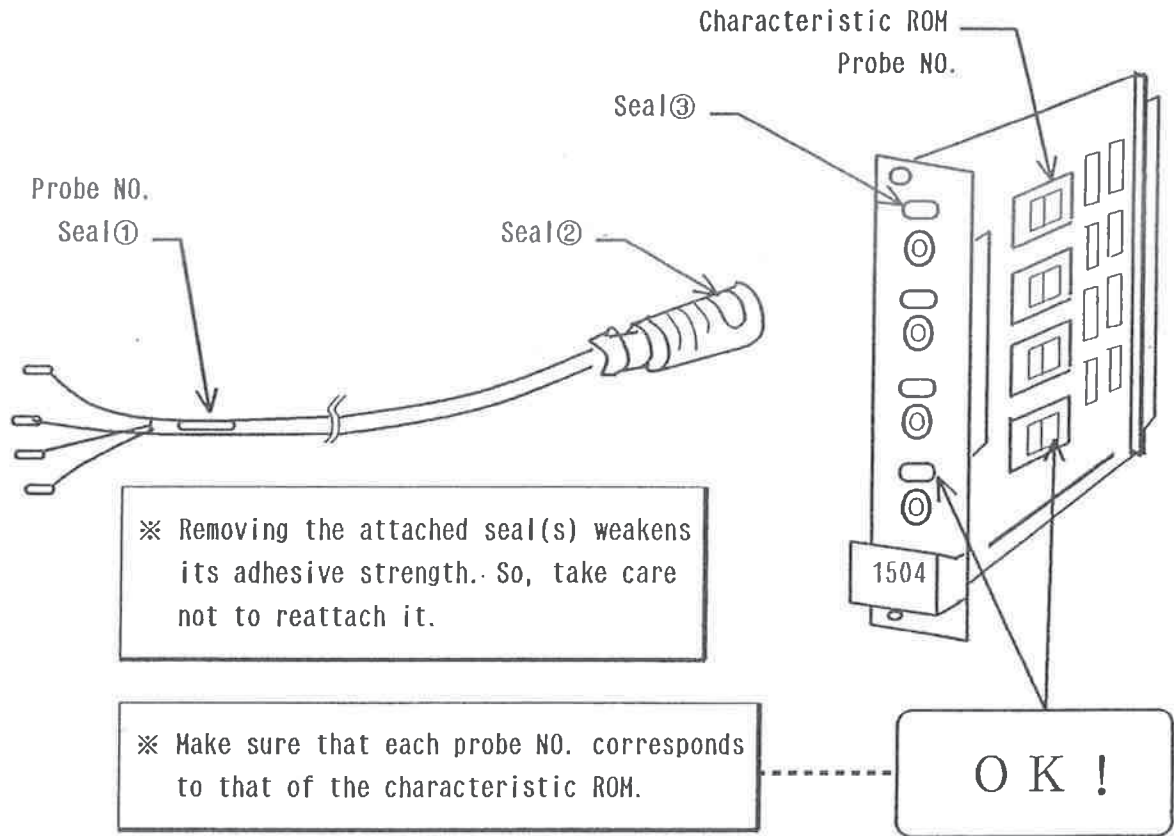

Connecting a probe cable to each module

Connect a probe cable to each module while taking care to ensure the cable NO. is the same as the probe NO. attached on the module.

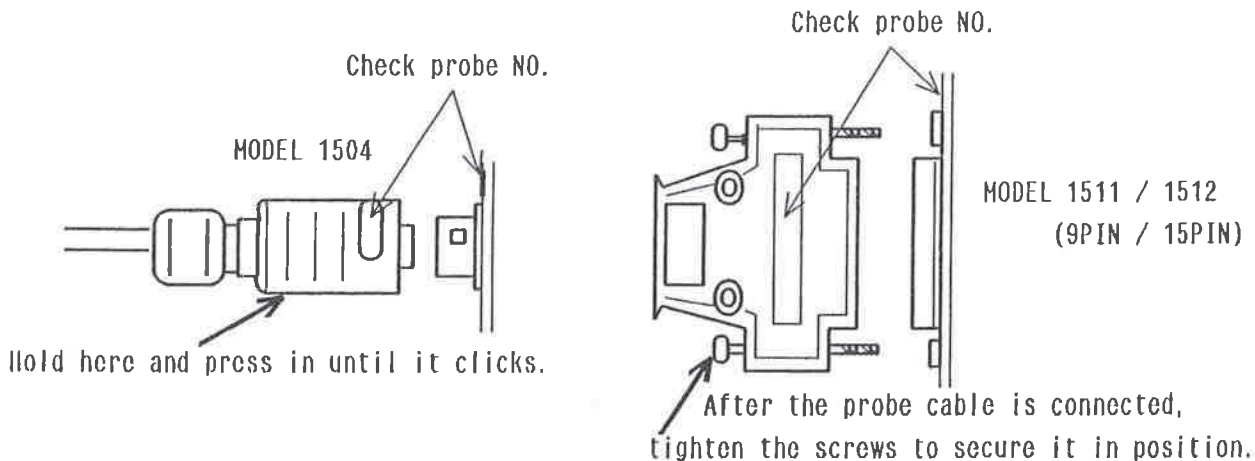

### Connecting a probe

※ Connect and disconnect the probe only after the main switch is turned off, as the probe element may burn to thereby change its characteristics or probe element wire may be broken.

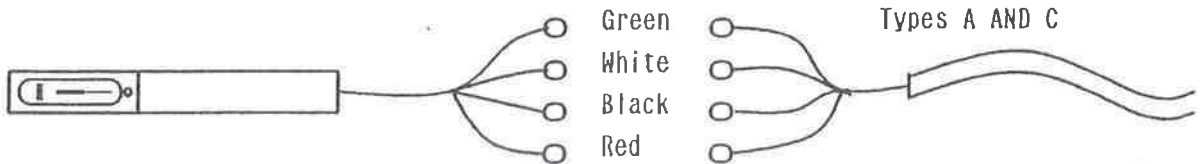

◆ Be sure that the wires of same color are connected together. Otherwise the probe may be damaged.

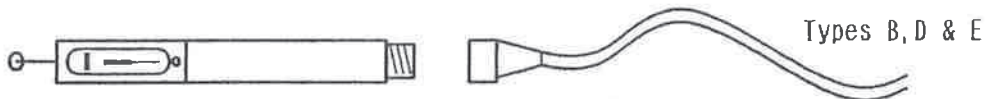

※ Firmly fasten the probe to avoid causing damage to the probe due to poor contact.

### Setting the probe

※ Be sure to set the probe with the wind direction mark facing windward. Although a spherical sensor and other nondirectional probes can measure air characteristics irrespective of air flow directions, calibration is performed with the air flow direction mark facing windward.

※ The higher the air velocity is, the better the response for air temperature becomes. Specifically, a response of approx. 20 to 30 seconds is obtained at 1 m/sec of air velocity. Take the reading when the indication has become stable.

※ Measuring an air flow for temperature in an airflow-free condition gives an indication of higher temperature. Therefore, to measure air temperature with accuracy, it is necessary to maintain the air velocity at more than 0.1 m/sec.

※ Performing prolonged measurement in an atmosphere of high humidity or measurement in an atmosphere subjected to a sudden temperature change may cause dew condensation, which may in turn give a measured value of abnormally high humidity. When such dew condensation is observed, leave the system standing at a relative humidity of below 40%RH for 24 hours.

[An Example]

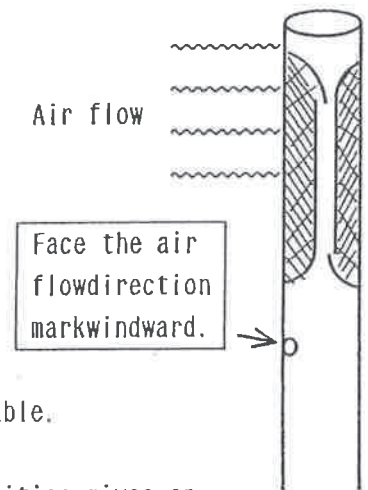



# NOTE OF THE PROBE NO. AND THE MODULE NO. STEP 7

Write down the probe NO. and the module NO. under the table for preventing a mistake of the channel NO.

MODULE NO. (V)	PROBE NO.			
	V1	V2	V3	V4
1				
2				
3				
4				
5				
6				
7				
8				
9				
10				
11				
12				
13				
14				
15				
16				

MODULE NO. (VT)	PROBE NO.	
	VT1	VT2
1		
2		
3		
4		
5		
6		
7		
8		
9		
10		
11		
12		
13		
14		
15		
16		

MODULE NO. (VTH)	PROBE NO.
	VTH
1	
2	
3	
4	
5	
6	
7	
8	
9	
10	
11	
12	
13	
14	
15	
16	

For the mixed modules (V,VT and VT module)

MODULE		PROBE NO.								MEMO
NAME	NO.	CH	NO.	CH	NO.	CH	NO.	CH	NO.	
V	1									
V	2									
V	3									
VT	4									
VT	5									
V	6									
VTH	7									
V	8									
VT	9									
VT	10									
V	11									
	12									
	13									
	14									
	15									
	16									

[ An Example ]

MODULE		PROBE NO.								MEMO
NAME	NO.	CH	NO.	CH	NO.	CH	NO.	CH	NO.	
V	1	V1	0001	V2	0002	V3	0003	V4	0004	
V	2	V1	0015	V2	0016	V3	0017	V4	0018	
V	3	V1	0029	V2	0030	V3	0031	V4	0032	
VT	4	VT1	1011	VT2	1012					
VT	5	VT1	1015	VT2	1016					
V	6	V1	0009	V2	0010	V3	0011	V4	0012	
VTH	7	VTH	2001							
V	8	V1	0129	V2	0130	V3	0131	V4	0132	
VT	9	VT1	1111	VT2	1112					
VT	10	VT1	1115	VT2	1116					
V	11	V1	0109	V2	0110	V3	0111	V4	0112	
	12									
	13									
	14									
	15									
	16									

- ◆ When the steps (1) ~ (7) have been performed, turn on the main switch.  
This will display the following screen (for Module V )

Module NO. (Address + 1 )

Module Name

(M-01)		[V]
V1	12.5	m/s
V2	15.3	m/s
V3	14.7	m/s
V4	13.9	m/s
[MANUAL]		

☆V : Air Velocity (4 channels)

☆VT : Air velocity and temperature  
(2 channels each )

☆VTH : Air velocity, temperature and relative  
humidity (1 channel each )

Operation mode ( can be selected using operation key )

- ☆ MANUAL ... Allows module selection for display by operating the [UP] and [DOWN] Keys.
- ☆ AUTO ..... Automatically changes modules every 2 seconds for display.

※ When no module is mounted, the screen shown in the figure on the right will appear. In this case, make preparations for measurement once again in accordance with the steps (1) to (7)

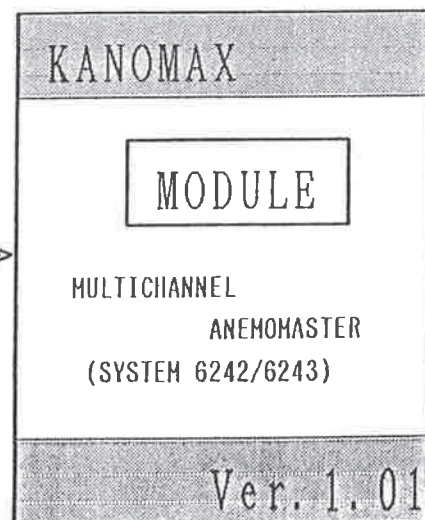

Examples of the screen for the mixed modules.

(M-01)		[V]
V1	12.5	m/s
V2	15.3	m/s
V3	14.7	m/s
V4	13.9	m/s
[AUTO]		



(M-02)		[V]
V1	13.4	m/s
V2	16.7	m/s
V3	15.3	m/s
V4	12.9	m/s
[AUTO]		



(M-03)		[VT]
V1	16.3	m/s
T1	25.8	°C
V2	14.6	m/s
T2	26.5	°C
[AUTO]		



(M-04)		[VT]
V1	13.8	m/s
T1	26.5	°C
V2	12.8	m/s
T2	24.7	°C
[AUTO]		



(M-05)		[VTH]
V	13.8	m/s
T	25.7	°C
H	43.8	%RH
[AUTO]		



(M-06)		[V]
V1	14.6	m/s
V2	16.8	m/s
V3	13.3	m/s
V4	12.7	m/s
[AUTO]		





MEMO

A large rectangular area with a solid border, containing 20 horizontal dotted lines for writing.

MEMO

A large rectangular area with a solid border, containing 20 horizontal dotted lines for writing.

# TABLE OF CONTENTS-CHAPTER 3

## PRINTING DATA

◆ PRINTING DATA .....	2 0
Connecting a printer cable .....	2 0
Connector pin allocation .....	2 0
Operation method .....	2 1
Examples of the printing data .....	2 2
◆ PRINTING PRECAUTIONS .....	2 3
Data overflow .....	2 3
Others .....	2 3

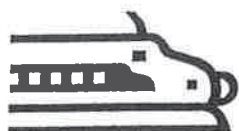



# PRINTING DATA

## Connecting a printer cable

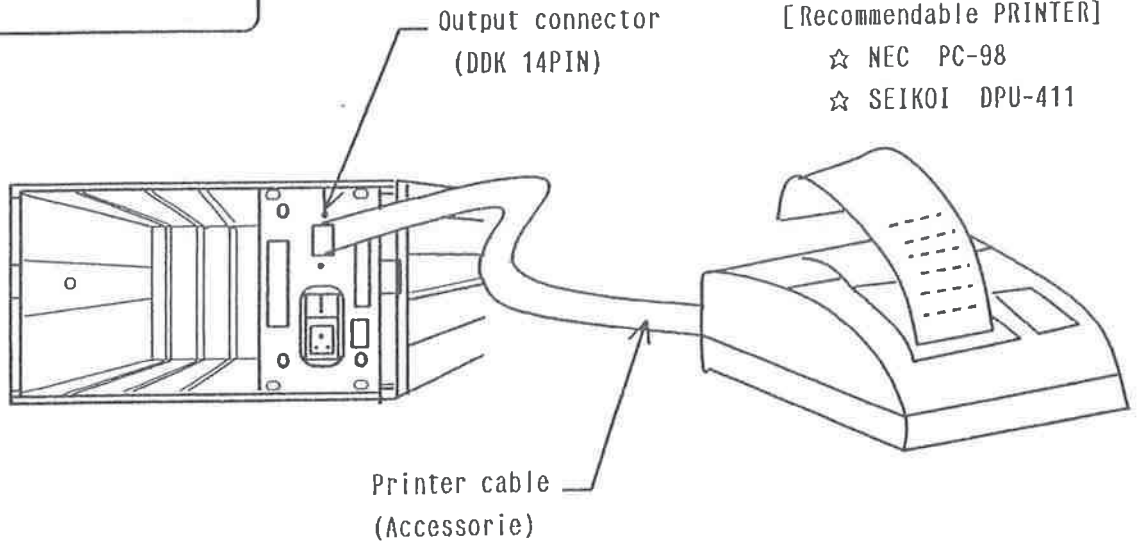

[Recommendable PRINTER]

☆ NEC PC-98

☆ SEIKOI DPU-411

## Connector pin allocation

Pin NO.	Signal name	
1	PSTB ( STROBE )	
2	PDB <sub>0</sub>	DATA
3	PDB <sub>1</sub>	
4	PDB <sub>2</sub>	
5	PDB <sub>3</sub>	
6	PDB <sub>4</sub>	
7	PDB <sub>5</sub>	
8	PDB <sub>6</sub>	
9	PDB <sub>7</sub>	
10	NC	
11	BUSY	
12	NC	
13	NC	
14	GND	

Setting switch DIP-SW 1  
for printer DPU-411

SW 1	ON	Parallel
SW 2	ON	Return
SW 3	OFF	Reduction(80)
SW 4	ON	Normal
SW 5	ON	O
SW 6	ON	Japanese
SW 7	ON	
SW 8	ON	

※SW-2: none

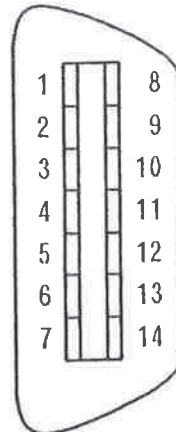

Operation Method

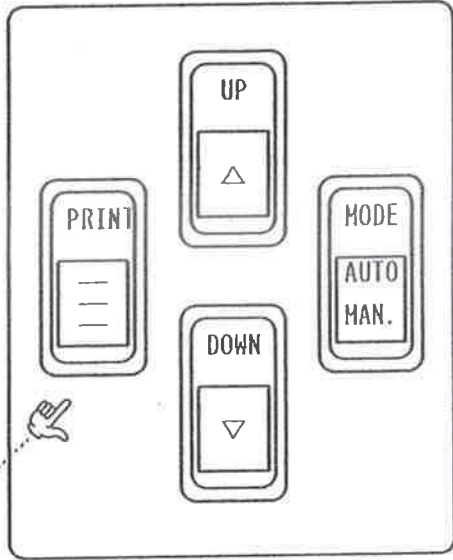
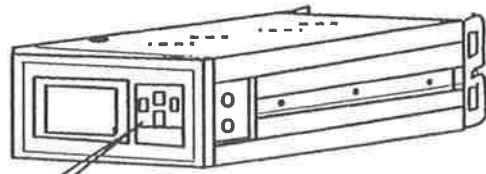

Press the PRINT key.

The data currently displayed on the screen is printed.

(M-01)		[V]
V1	12.5	m/s
V2	13.6	m/s
V3	12.9	m/s
V4	14.7	m/s
[AUTO]		[PRINT]

[PRINT] is displayed (whether or not the printer is connected.) Data is output whether or not the printer is connected.

- ◆ Data is printed every 2 seconds on a module basis. To be more specific, all data displayed on the screen is printed at a time, and is followed 2 seconds later by printing the data of the next module screen. ( Example : for Module V, data from the four channels is printed at a time. )

(M-01)		[V]
V1	12.5	m/s
V2	13.6	m/s
V3	12.9	m/s
V4	14.7	m/s
[AUTO]		[PRINT]

2 seconds later

(M-02)		[V]
V1	12.1	m/s
V2	14.5	m/s
V3	13.7	m/s
V4	14.3	m/s
[AUTO]		[PRINT]

Print output

Printing data of 4 channels (v1,V2,V3 & V4) at a time.

Print output

- ◆ To stop printing, press the PRINT key again.

Examples of the printing data

[AUTO MODE]

Automatically changes modules every 2 second for printing data.

M-01	12.5 m/s	10.3m/s	11.5m/s	12.4m/s
M-02	13.4 m/s	12.1m/s	14.1m/s	13.5m/s
M-03	12.7 m/s	21.4°C	13.5m/s	22.6°C
M-04	12.9 m/s	23.5°C	43.7%RH	
M-05	13.5 m/s	12.4m/s	12.8m/s	13.7m/s
⋮				
⋮				
⋮				

[MANUAL MODE]

Automatically changes modules every 2 second for printing data.

Printing data for display by operating the [UP] and [DOWN] keys.

M-01	12.5 m/s	11.3m/s	12.5m/s	12.4m/s
M-01	13.4 m/s	12.1m/s	14.6m/s	13.5m/s
M-01	12.7 m/s	10.3m/s	13.2m/s	12.4m/s
M-01	13.8 m/s	13.5m/s	15.1m/s	13.4m/s
M-01	13.5 m/s	13.9m/s	13.3m/s	13.9m/s
M-02	12.7 m/s	21.4°C	13.5m/s	22.6°C
M-02	12.5 m/s	21.2°C	12.7m/s	21.8°C
M-02	11.9 m/s	20.9°C	13.2m/s	21.9°C
M-03	12.9 m/s	23.5°C	43.9%RH	
M-03	12.8 m/s	23.4°C	43.7%RH	
M-03	12.5 m/s	23.3°C	43.5%RH	
M-03	12.7 m/s	23.2°C	43.8%RH	
M-04	13.6 m/s	14.1m/s	13.8m/s	13.7m/s
M-05	13.2 m/s	22.5°C	13.6m/s	23.5°C

# PRINTING PRECAUTIONS

---

## Data overflow

- ※ Data is output to the printer through the system buffer. When you are using a slow printer, data is being gradually stored in the buffer. So, when the buffer has become full, a [PR ERR] message will be displayed on the screen. Although this error takes place, data will be continuously output, but with no guarantee of every 2 second output. In this case, some data may not be printed (namely, omitted).

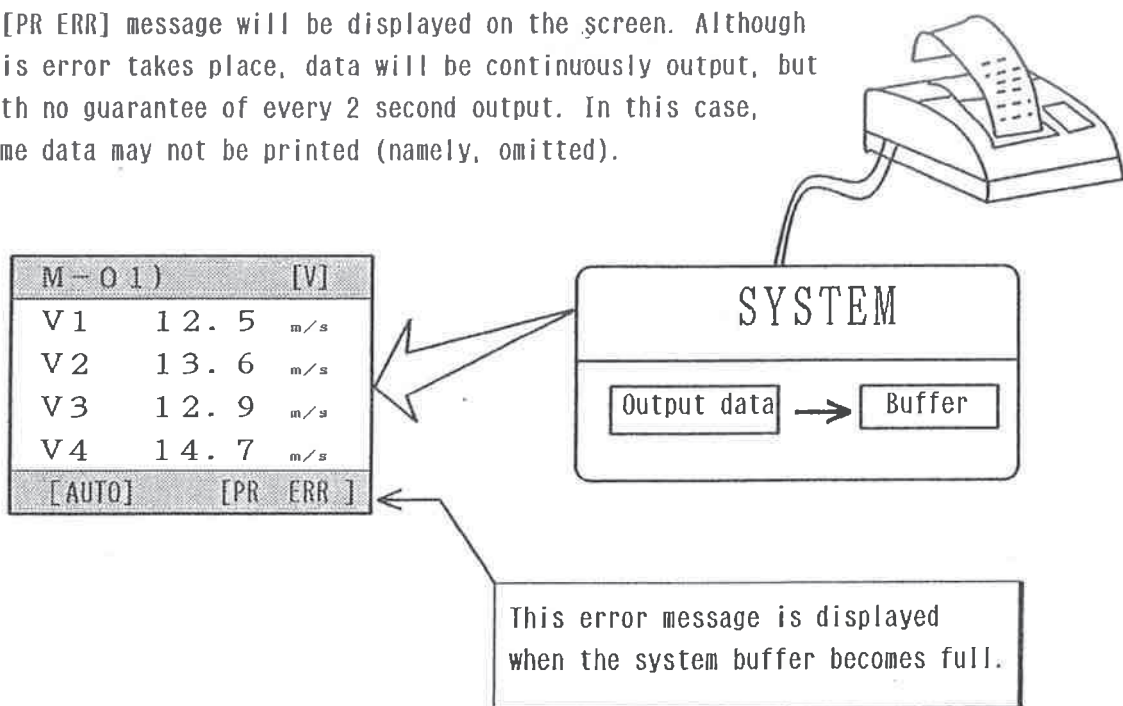

## Others

- ※ Data is output in a text format. This means that basically any printer which supports CENTRONICS can output data. However, the symbol [°C] used as a temperature unit may not be correctly output because the printer font differs depending on printer types.
- ※ Data is output whether or not the printer is connected. When the printer is connected in the outputting process, data will be printed from that point. To print from the very beginning, temporarily press the PRINT key to suspend the printing and then press the PRINT key again.

MEMO

A large rectangular area with a solid border, containing 20 horizontal dotted lines for writing.

# TABLE OF CONTENTS-CHAPTER 4

## RS-232C DATA TRANSFER

◆ OVERVIEW OF DATA TRANSFER .....	2 6
◆ OUTPUT CONNECTOR .....	2 7
◆ CHECKING THE OUTPUT FORMAT .....	2 8
◆ DESCRIPTION OF MEASUREMENT MODES .....	2 9
(BURST MODE AND CHANNEL MODE )	
◆ OUTPUT FORMAT (1) BURST MODE .....	3 1
◆ OUTPUT FORMAT (2) CHANNEL MODE .....	3 3
◆ TIMING CHART FOR DATA READING .....	3 4
◆ DESCRIPTION ON COMMANDS .....	3 6
◆ SETTING THE DELIMITER ( CR, CR/LF) .....	4 0
◆ ERROR FLAG (RETURN CODE) .....	4 1
◆ COMMAND INPUT PROCEDURE .....	4 2
◆ EXAMPLE OF PROGRAM TO TAKE DATA .....	4 3

# OVERVIEW OF DATA TRANSFER

◆ Setting an output format

- ☆ Remote mode ;  
data transfer status
- ☆ Local mode ;  
displayed on LCD

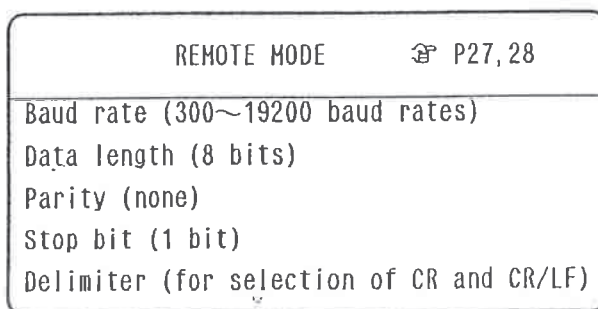

◆ Selecting measurement mode

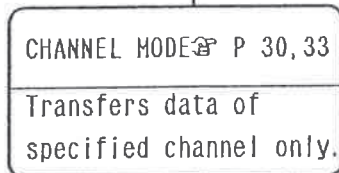
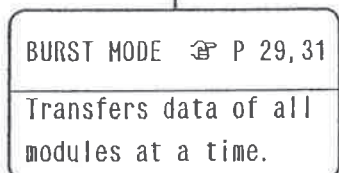

◆ Selecting data

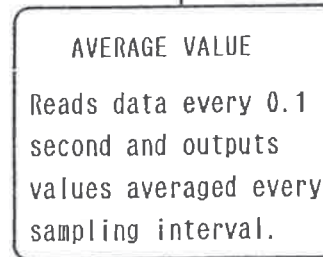
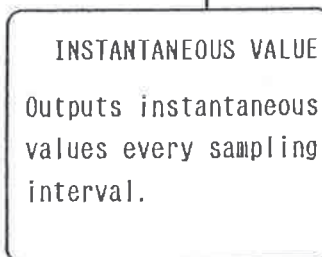
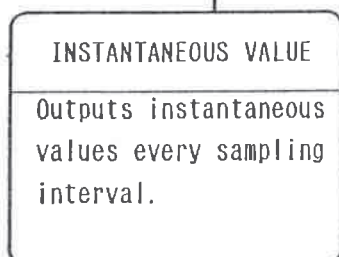

◆ Setting measurement conditions

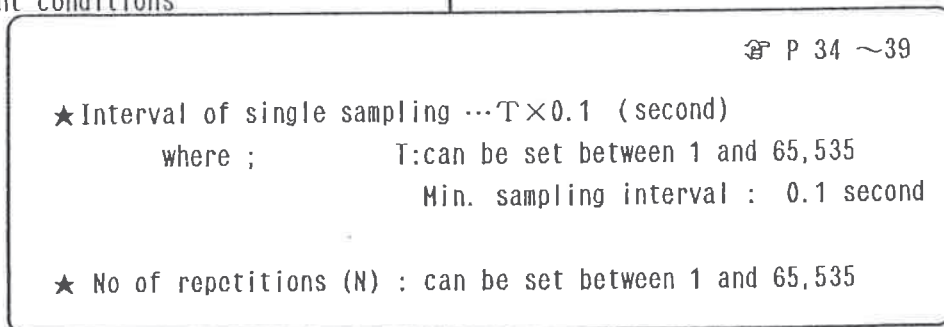

◆ Starting measurement





# OUTPUT CONNECTOR

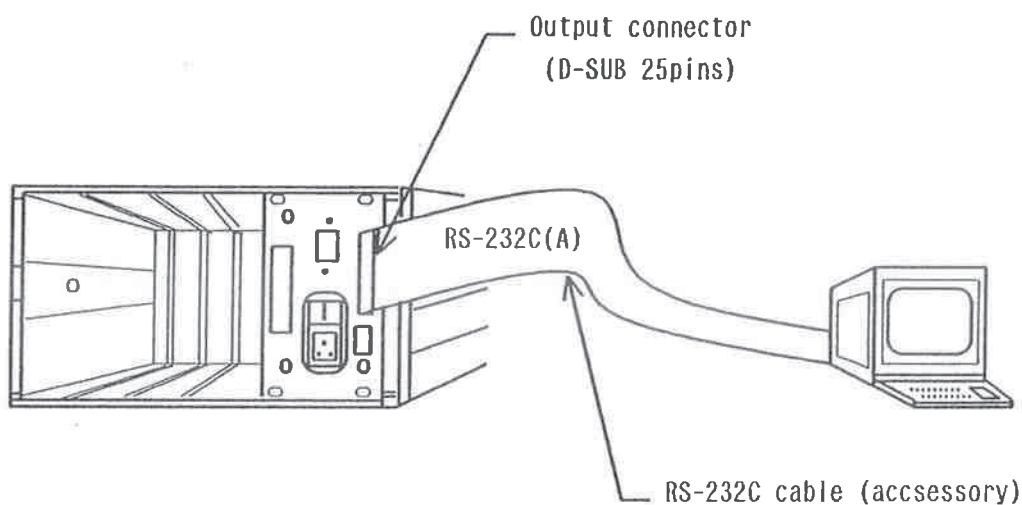

## Connector Pin Allocation

[ Example ]---NEC PC-9800 Series

Cable : straight splicing type

Computer side		Wiring	System Side (SYSTEM 6242/6243)			
Signal name	Pin NO.		PIN NO.	Signal name	signal Description	
	1		1			
TXD	2	.....	2	RXD	Received data Input	
RXD	3	.....	3	TXD	Transferred data Output	
RTS	4	.....	4	CTS	clear to send INPUT	
CTS	5	.....	5	RTS	Request to send Output	
DSR	6	.....	6			
GND	7	.....	7	GND	Signal ground	
DCD	8		8			
	9		9			
	10		10			
	11		11			
	12		12			
	13		13			
	14		14			
	15		15			
	16		16			
	17		17			
	18		18			
	19		19			
	20		20			
	21		21			
	22		22			
	23		23			
	24		24			
	25		25			

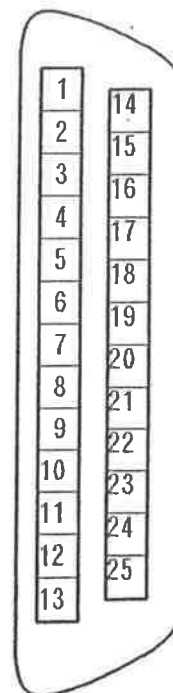

# CHECKING THE OUTPUT FORMAT

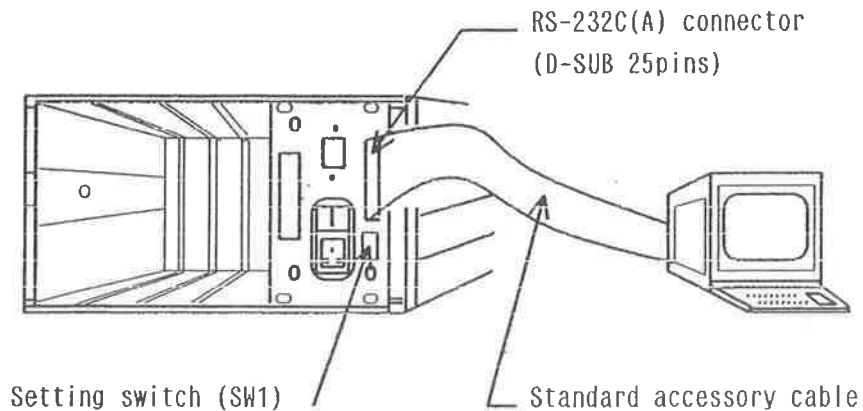

Baud Rate	SW 1		
	1	2	3
300 Baud	ON	ON	ON
600 Baud	OFF	ON	ON
1200 Baud	ON	OFF	ON
2400 Baud	OFF	OFF	ON
4800 Baud	ON	ON	OFF
9600 Baud	OFF	ON	OFF
19200 Baud	ON	OFF	OFF

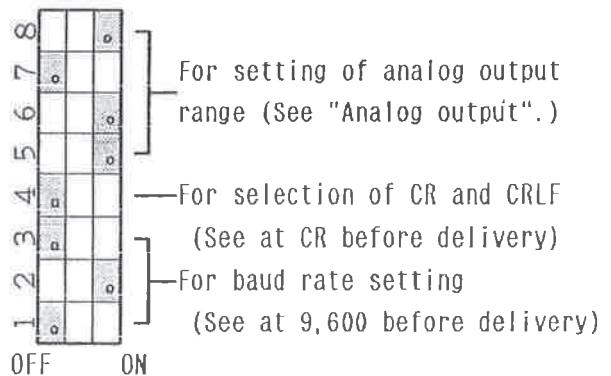

 Switch

Data length	8 bit
Parity	none
Stop bit	1 bit

Delimiter	SW 1
CR/LF	ON
CR	OFF

※ Only CR is applicable to the compatibility mode of system 6241 (old system).

## [Check Items]

- (1) Set the required baud rate as specified in table above using the SW 1 (1)~(3).  
Also, check the host computer for the correct baud rate setting. In order to ensure data transmission between the system and the computer, their baud rate setting must be the same. If not, an error code will be returned at data transmission.
- (2) Check for data length, parity and stop bit.
- (3) A delimiter (CR/LF) has an effect on the entire communication system. Check to see that it is properly set.

# DESCRIPTION OF MEASUREMENT MODE BURST MODE AND CHANNEL MODE

## BURST MODE

- ◆ Outputs data (instantaneous values) of all modules in the specified sampling interval. Data for a total of 16 modules multiplied by the number of systems is output as a single data output.
- ◆ Transfers data for 16 modules even if all modules are not mounted. Any data for modules that are not mounted is treated as dummy data.

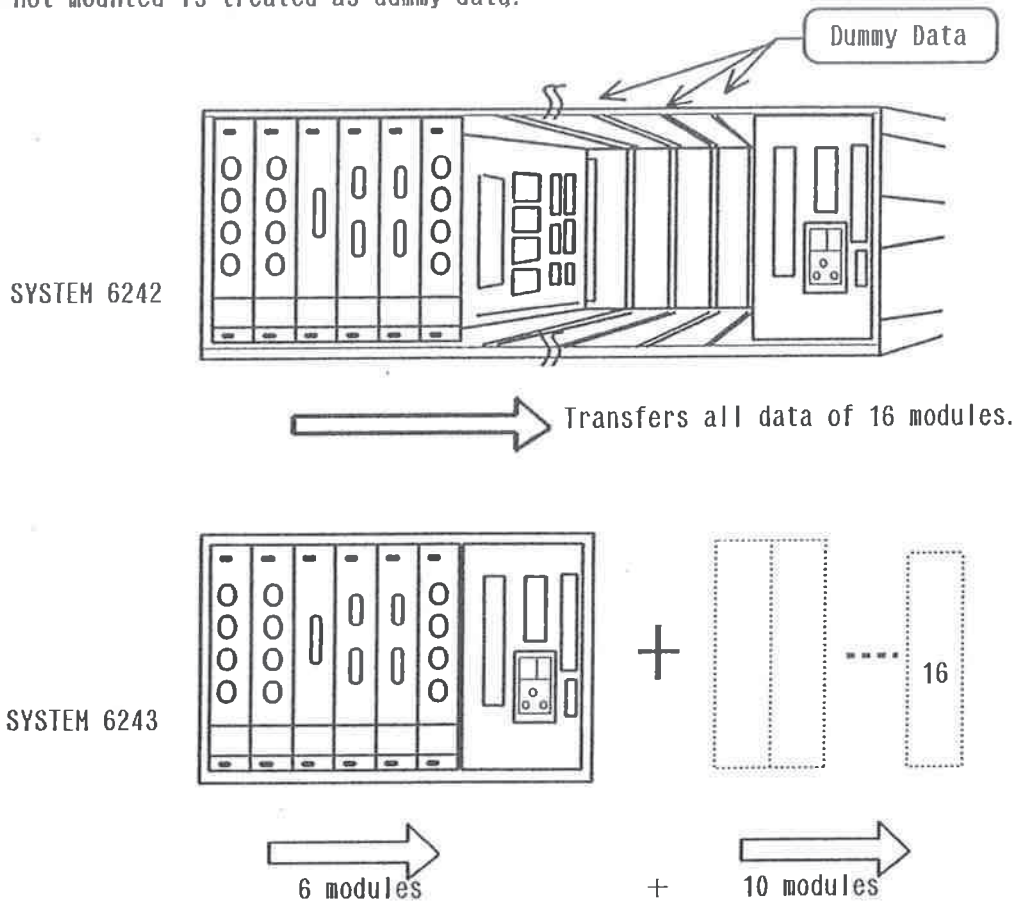

- ◆ System 6243 can accommodate only 6 modules, but transfers data as 16 modules, as with System 6242.
- ◆ The sampling interval to be set is constant irrespective of the number of systems (cascade-connected), the number of modules to be mounted, module types, and system models (Systems 6242/6243).

Sampling interval =  $T \times 0.1$  (sec) (T : can be set between 1 and 65,535)

Min. set sampling interval : 0.1 sec (T=1) Data is transferred every 0.1 sec.

Channel mode

( Module V )

		(M-01)		[V]
CH 1	→	V1	12.5	m/s
2	→	V2	13.8	m/s
3	→	V3	12.9	m/s
4	→	V4	11.4	m/s

☆For Module V, specify a channel for each probe.

( Module VT )

		(M-02)		[VT]
CH 5	→	V1	12.6	m/s
6	→	T1	24.8	°C
7	→	V2	11.8	m/s
8	→	T1	25.3	°C

☆For Module VT, specify A channel for a single probe to measure both velocity and temperature.

( Module VTH )

		(M-03)		[VTH]
CH 9	→	V	12.6	m/s
10	→	T	25.3	°C
11	→	H	43.7	%RH
12	→			

☆For Module VTH, specify a separate channel for a single probe to measure velocity, temperature and humidity.  
Channel 4 will be a dummy CH.

- ◆ Delimits the output scope from which channel to which channel, and then outputs.  
For example, Channels 5 to 16 can be specified for output.
- ◆ The sampling interval is constant irrespective of the number of channels to be specified, etc. as with the burst mode. (i.e,  $T \times 0.1$  second, T:1~65,535, see P.29.)
- ◆ For data transfer, the instantaneous value mode and the average value mode are available. (See Pages 34 & 35)
- ◆ The module Nos. correspond to the channel Nos. and they are fixed. To specify the channels for data output, see the tabel below. When two or more systems are to be connected, specify the channels as 1 to 64 channels of System N. (See Page 37)

MODULE	CH				MODULE	CH			
M-01	1	2	3	4	M-09	33	34	35	36
M-02	5	6	7	8	M-10	37	38	39	40
M-03	9	10	11	12	M-11	41	42	43	44
M-04	13	14	15	16	M-12	45	46	47	48
M-05	17	18	19	20	M-13	49	50	51	52
M-06	21	22	23	24	M-14	53	54	55	56
M-07	25	26	27	28	M-15	57	58	59	60
M-08	29	30	31	32	M-16	61	62	63	64

- ※ Module VI : V1~CH1, I1~CH2, V2~CH3, I2~CH4 (V and T are counted as separate channels.)
- ※ Module VII : V~CH1, T~CH2, H~CH3, \*~CH4 (Counted as 4 channels)
- ※ Even if a certain module is not mounted, its corresponding channel NO. remains unchanged.

# OUTPUT FORMAT (1) BURST MODE

- ◆ One data set of each channel has 4 digits.
- ◆ One record (a separation of a series of data) consists of 32 data sets ( for 32 channels ), and CR OR CR/LF is transferred every 32 data sets, namely every eight modules.
- ◆ A signal module consists of 4 data sets (for 4 channels). Therefore, for the module VTH (air velocity, temperature and humidity), the fourth data set will be a dummy data set .

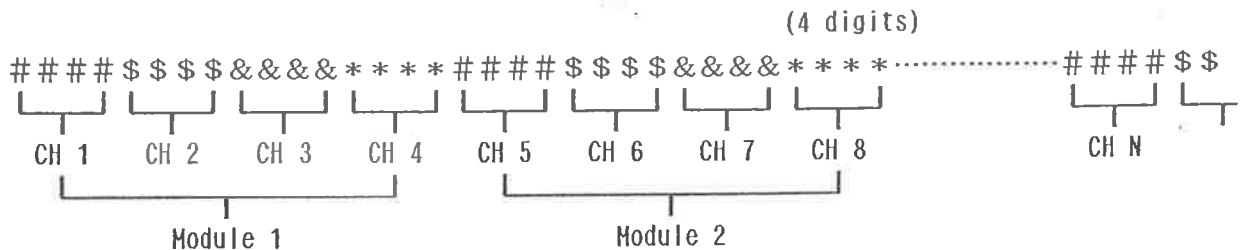

★★★ Both the systems 6242/6243 have the same output format. ★★★

## (1) System 6242

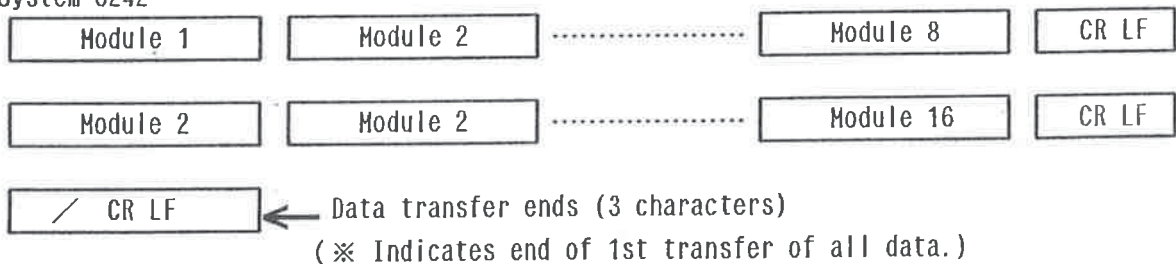

## (2) System 6243

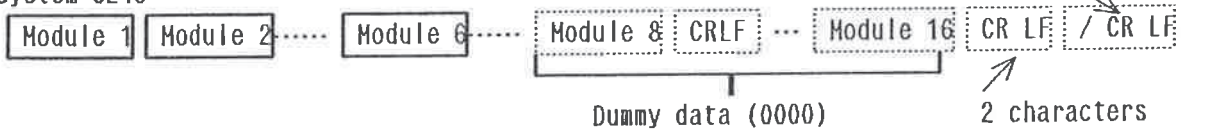

- ※ Even if all the modules are not mounted, data for up to 16 modules will be output. If any module NO. or channel is missing, dummy data (0000 or \*\*\*\*) for the missing portion will be transferred.
- ※ The system 6243 can accommodate 6 modules, and data for Modules 7 to 16 will be handled as dummy data.
- ※ When more than two system are used, the data [/ CR LF] is transferred after the data of the last system is transferred.



Examples of data transfer

◆ Module V ( Air velocity : 4 channels)

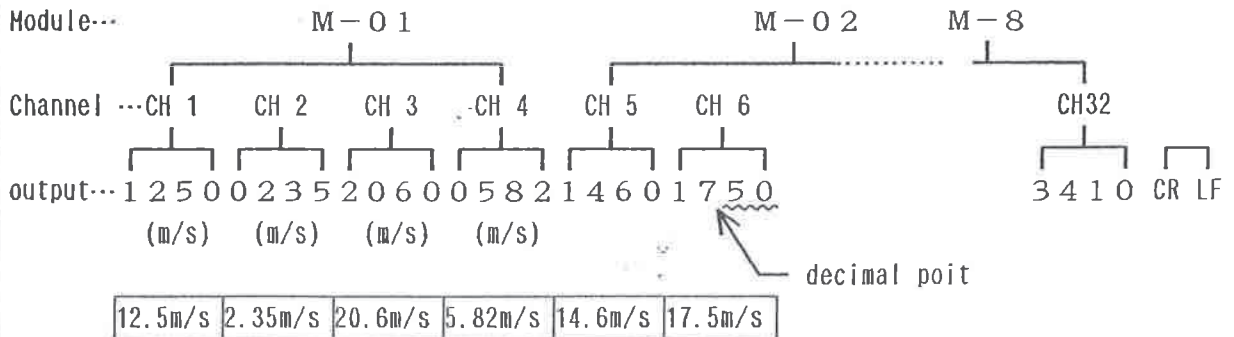

◆ Module VT (Air velocity and temperature : 2 channels each)

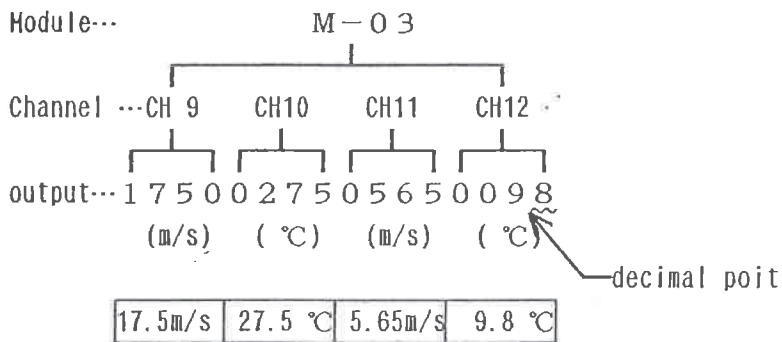

◆ Module VTH (Air velocity, temperature and humidity : 1 channel each)

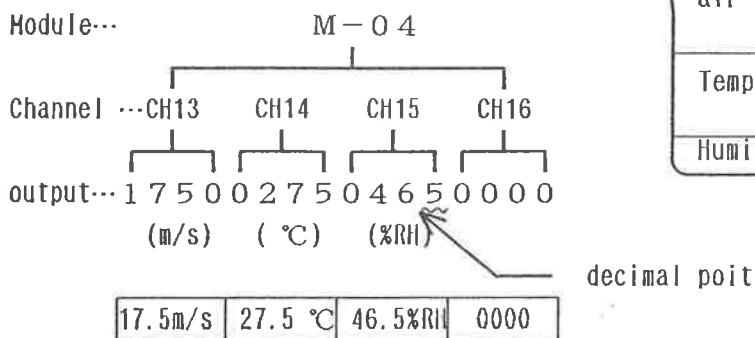

	Resolution	
air Velocity	0 ~ 9.99m/s	0.01m/s
	10.0 ~ 50.0m/s	0.1 m/s
Temperature	0.0 ~ 99.9°C	0.1 °C
	100°C ~	1.0 °C
Humidity	0 ~ 99.9%RH	0.1 %RH

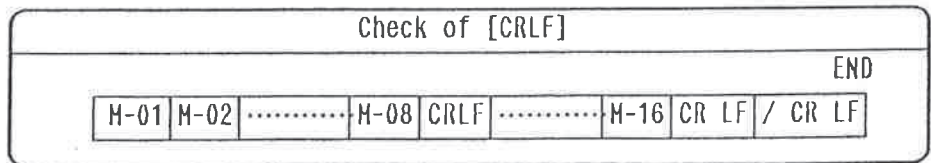

# OUTPUT FORMAT (2) CHANNEL NODE

- ◆ Outputs measured values for the specified channel. For channel numbers, see "Description of Measurement Mode " (P.30). (Check these channel numbers using the table which shows the relationship between the modules in the channel mode and the channel numbers.)
- ◆ Outputs data in the following format.

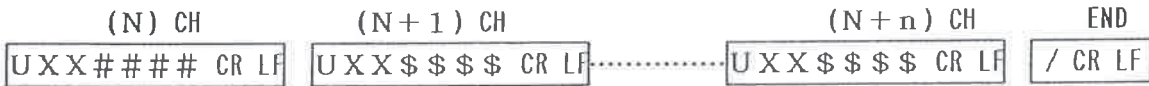
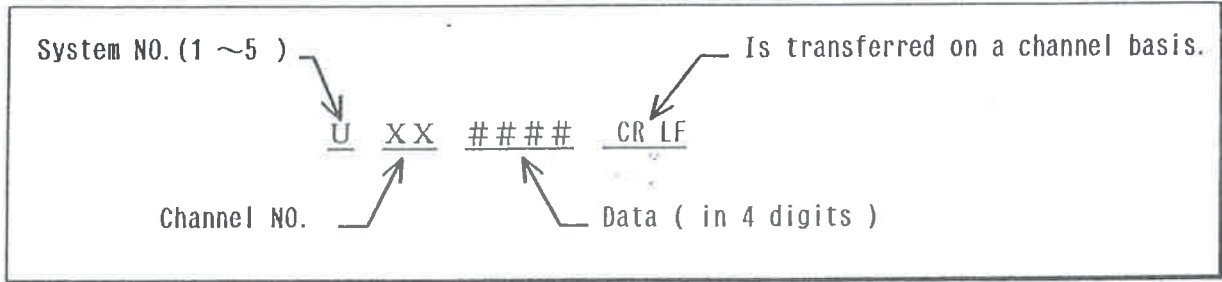

[Example]--- 1 system, Module V, and 5 to 16 output channels

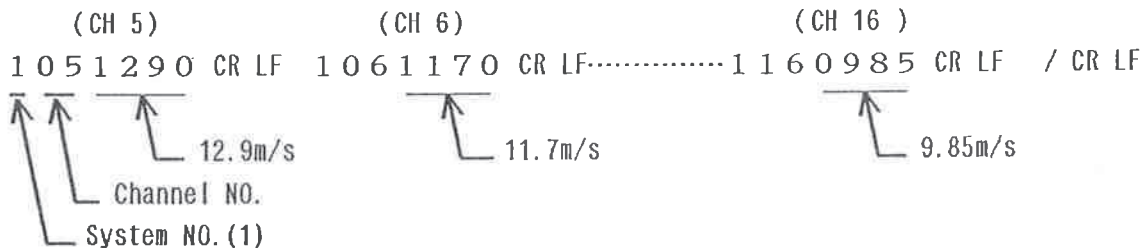

## Screen display during data transmission

- ※ The screen shown in the figure on the right is displayed during data transmission ( the screen being the same for both the burst and channel modes.)
- ※ Completing the data transmission returns to the original screen.
- ※ No operation keys function during transmission.

Selected measurement mode is displayed.

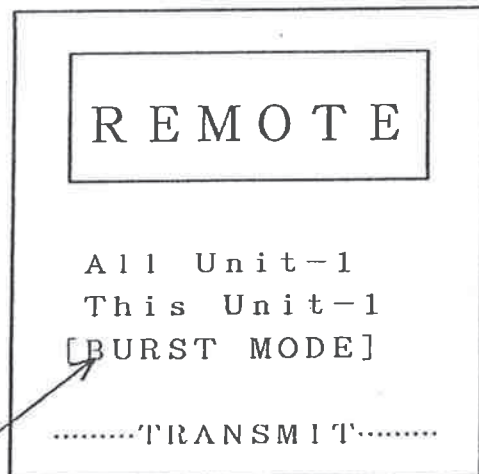



# TIMING CHART FOR DATA READING

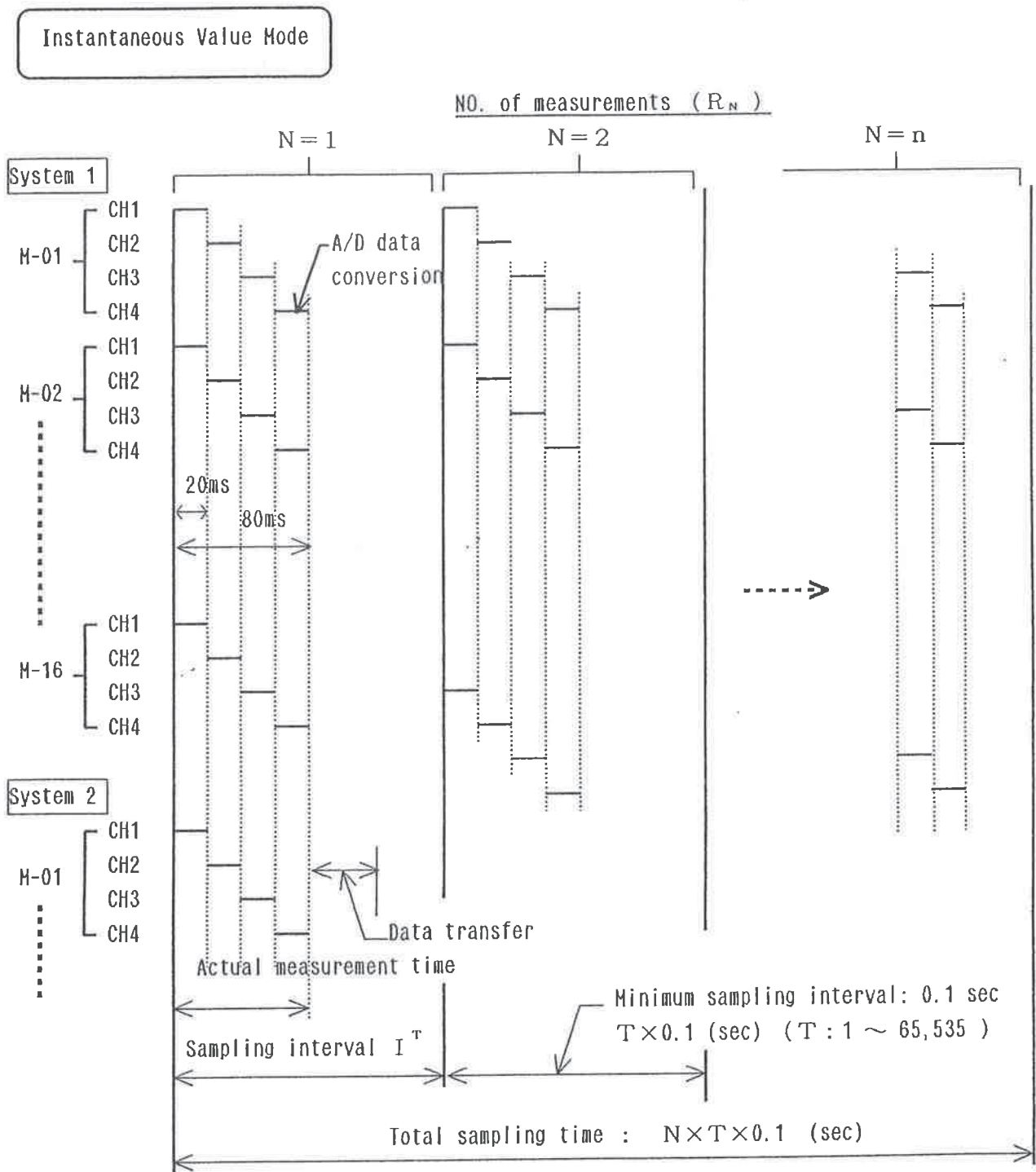

- ◆ Data of Channel 1 for each module is simultaneously A/D converted, and completing A/D data conversion for Channel 4 starts data transmission. The minimum sampling interval is 0.1 second. When a longer sampling interval is set, the system performs data transmission and waits until subsequent measurement is initiated.
- ◆ The data transfer time depends on the set baud rate, the number of systems, etc.

**Average Value Mode**

...Active only in the channel mode. (not available in the burst mode)

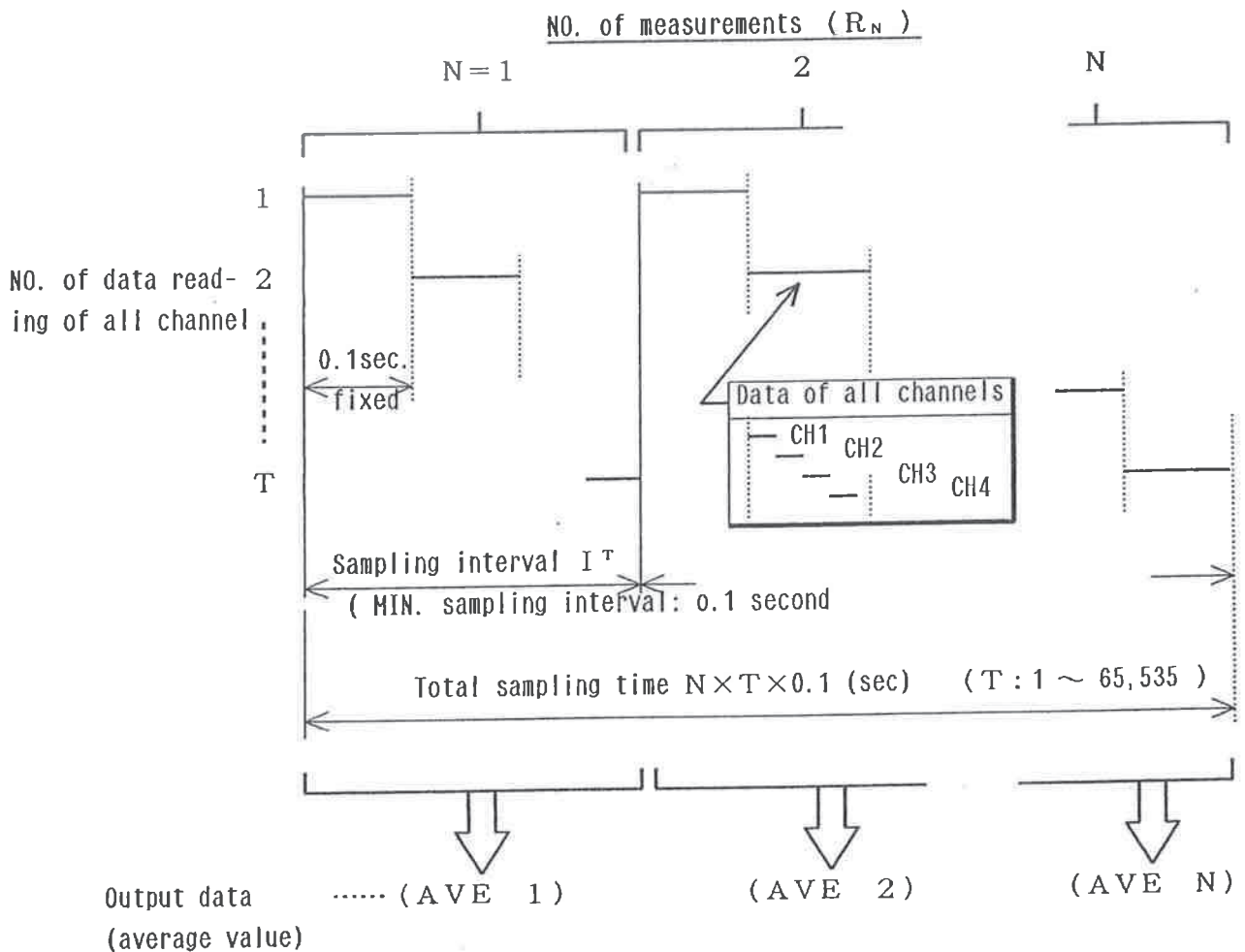

◆ During the set sampling interval, the channel mode allows reading all data for the specified channel every 0.1 second to output the average value.

[Example] For 10 seconds of sampling interval, data is read every 0.1 second a total of 100 times, and its average value is output every 10 seconds.

◆ The minimum sampling interval is 0.1 second, and when it is set at 0.1 sec., data is read only one time, thus giving the value that is equivalent to the instantaneous value.

# DESCRIPTION ON COMMANDS

## Remote Mode

Function	Comand	Description
Remote Execute (OPEN)	@ (CR/LF)	<p>Selects the remote mode.            ※[REMOTE] is displayed on the screen, disabling the key operation.            After data transmission the following two comands are returned.</p> <div style="border: 1px solid black; padding: 5px; margin: 10px 0;"> <p>@1(CR/LF) @X(CR/LF) X; 1~5 ( NO. of systems)</p> </div> <p style="margin-left: 40px;"> <span style="margin-right: 100px;">↙ OK!</span> <span>↙ NO. of systems connected</span> </p> <p>When abnormal data transmission takes place, the signal E(CR/LF) is returned.</p>
Remote Cancel (CLOSE)	L (CR/LF)	<p>Returns to the original measurement screen (local mode). Ends receive of communication command, disabling key operation.</p> <p>※ The set values are still stored even after the local mode is restored unless the main switch is turned off. Turning off power returns to the initialization state.</p>

## Starting Measurement

Function	Comand	Description						
Measurement start	S (CR/LF)	<p>Starts measurement and outputs measured values. Before starting measurement, be sure to set the output mode, number of measurements and sampling interval. If they are not yet set, measurement is started with the following settings being as defaults.</p> <table border="1" style="margin-left: auto; margin-right: auto;"> <tr> <td>Output mode</td> <td>Burst mode</td> </tr> <tr> <td>NO. of measurements</td> <td>one</td> </tr> <tr> <td>Sampling interval</td> <td>0.1 second</td> </tr> </table> <p>Initial setting</p>	Output mode	Burst mode	NO. of measurements	one	Sampling interval	0.1 second
Output mode	Burst mode							
NO. of measurements	one							
Sampling interval	0.1 second							

Measure Mode Selection

Function		Comand	Description
B U R S T	Burst mode selection	B (CR/LF)	Outputs all channel data at time.
	End setting	Hxx (CR/LF)	Can specify an end channel when in the burst mode. [EX.] H 1 2 : Indicates that measurement ends ↖ at channel 12.
C H A N N E L	Channel mode selection	C (CR/LF)	Outputs data of a specific channel only.
	Scope of selection	Unxx-xx (CR/LF)	<p>Delimits channels of which data is to be output.</p> <p>[EX.1] U 1 1 - 3</p> <p>Outputs data of channels 1 to 3.</p> <p>SYSTEM.NO. 1 for system 1 2 for system 2 and likewise</p> <p>[EX.2] U 2 5 - 8</p> <p>Outputs data of channels 5 to 8 for system NO.2.</p> <p>(System NO.2)...</p> <p>(System no.1)...</p> <p>For cascade connection which allows connection of more than two systems, see Chapter 5.</p>
	Clear	X (CR/LF)	<p>Initializes the channels (U11-1).</p> <p>※ To delimit the scope, be sure to transfer this CLEAR command first.</p> <p>[EX.] X (CR/LF) U 1 1 - 3 (CR/LF)</p> <p>※ Performing no CLEAR command overlaps the newly selected scope with previous ones.</p>

Data selection

Function	Comand	Description
Average value mode	M (CR/LF)	Active only in the channel mode. ◆ Reads data every 0.1 second and averages data every set sampling interval for subsequent output. ☞ P35
Instantaneous Value Mode	N (CR/LF)	Active in both the burst and channel modes. ◆ Outputs data of instantaneous values every set sampling interval. ☞ P34

Setting the Measurement Conditions

Function	Comand	Description
NO. of measurements	R <sub>N</sub> (CR/LF)	Repeats measurements 12 times if set at R12. (1 ~ 64CH) × N Where, N: number of repetitions. The setting range (N): 1 ~ 65,535
Setting a sampling interval	I <sub>T</sub> (CR/LF)	Sets what time interval at which measurement is conducted for all channels. ※ The sampling interval is constant irrespective of the number of modules, modules models and the number of system. Settable sampling interval: T * 0.1 sec. (T; Can be set between 1 and 65,535.)  [EX.] Setting at I10 allows data to be output every 1 second. 10 × 0.1 sec. ↗  The total sampling time is determined to be (N * T * 0.1) seconds.

Module Type

Function	Comand	Description
Module transmission	K (CR/LF)	<p>Displays modules mounted.</p> <p>Transmitting the command "K" returns a 32-byte character string.</p> <p>The number consisting of each two bytes from the beginning of a 32-byte character string shows the corresponding module model.</p> <p>Module 1 ; 2 bytes Module 2 ; 32 bytes</p> <p>※Both the systems (6242/6243) have a 32-byte character string returned.</p> <div style="border: 1px solid black; padding: 5px; margin: 10px auto; width: fit-content;"> <p>0... NO module mounted 1...Module V (MODEL 1504) 3...Module VT (MODEL 1511) 4...Module VTH(MODEL 1512)</p> </div>

[Example]

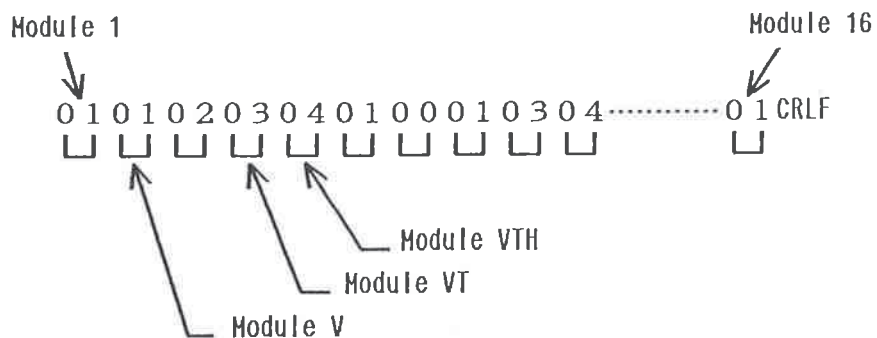



# SETTING THE DELIMITER (CR, CR/LF)

Applicable to both RS-232C and GP-IB interfaces.

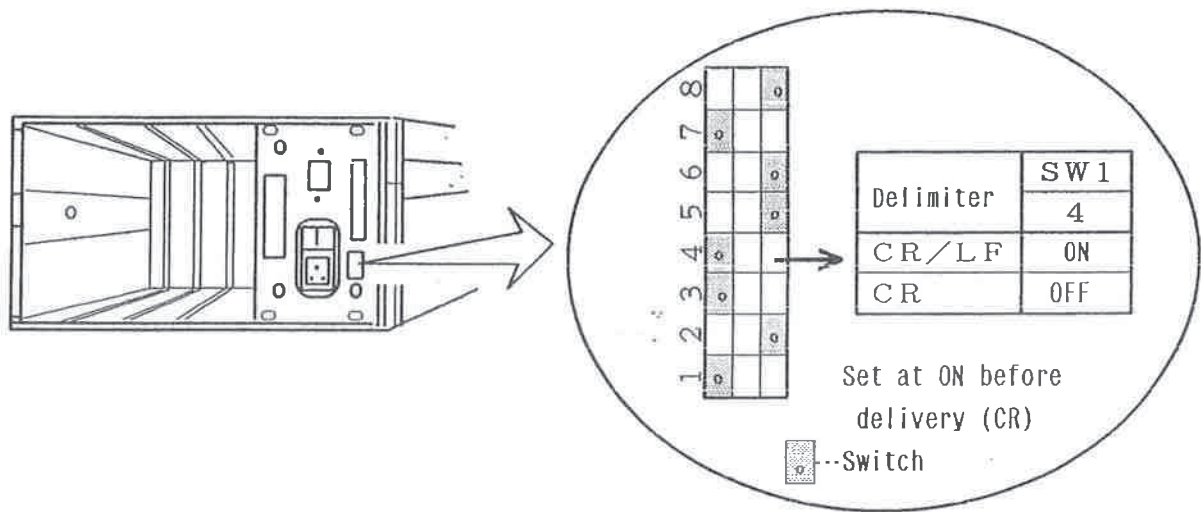

◆ In data communication between the system(s) and a host computer, the following types of delimiters are used to indicate the end of a record (of every 32 channels).

(1) The delimiter used to send a command to the system(S) from the host computer is CR(ODH) or CR(ODH)/LF(OAH).

[Example] ...@ (CR) C (CR) I 3 0 0 (CR/LF)

(2) To input two or more commands in succession, use ";".

[Example] ...C ; I 5 0 ; R 1 0 0 ; U 1 1 - 6 4 (CR/LF)

- ※ 20 characters is the maximum number that can be input in succession at this occasion, but use only the remote command (@) independently.
- ※ Do not input other commands continuously after the measurement start command (S) or the remote cancel command (L).
- ※ If other characters than CR and CR/LF exist after either S or L, an error flag is output, followed by measurement start or by returning to the local mode (normal sampling screen), neglecting the subsequent commands.

(3) An error flag or a measurement data delimiter transferred to the host computer from the system (S) can be set by either CR or CR/LF. Set the SW1-4 in accordance with the above table.

## ERROR FLAG (RETURN CODE)

(1)	@ 1 (CR/LF)	This flag is output only when the remote command is executed, indicating that normal communication has been done.
(2)	@X (CR/LF)	This is a flag which is output subsequent to the above "@1" (CR/LF)", indicating that how many systems are connected to a host computer.  [Example]... @ 1 (CR/LF) @ 4 (CR/LF) This example shows that 4 systems are connected to a host computer.
(3)	E (CR/LF)	This is output when an input command is wrong, executing no command. When the remote command (@) is wrong (as in the cases where @ is followed by other characters than CR or CR/LF), the system is reset to the local mode, and if there is an error taking place in that process, the commands up to the delimiter just before the error are normally received.
(4)	A (CR/LF)	Indicates that input of commands other than (@) has been normally received.
(5)	/ (CR/LF)	This is a send end flag of measurement data. Using this flag a measurement end signal and a data send end signal are sent to a host computer.
(6)	F/ (CR/LF)	A memory-full flag. When a sampling interval is shorter than the data send time, the system stops measurement when the memory buffer has become full (i.e. with 100 data sets), sends data of the buffer, then outputs this flag.
<p>※ These flags are returned on a command basis, and should be read by a host computer for identification of each error flag.</p> <p>※ If they are not read by a host computer, the host computer may be put in a standby state depending on the type of host computer used. As a result the computer may be locked.</p>		

# COMMAND INPUT PROCEDURE

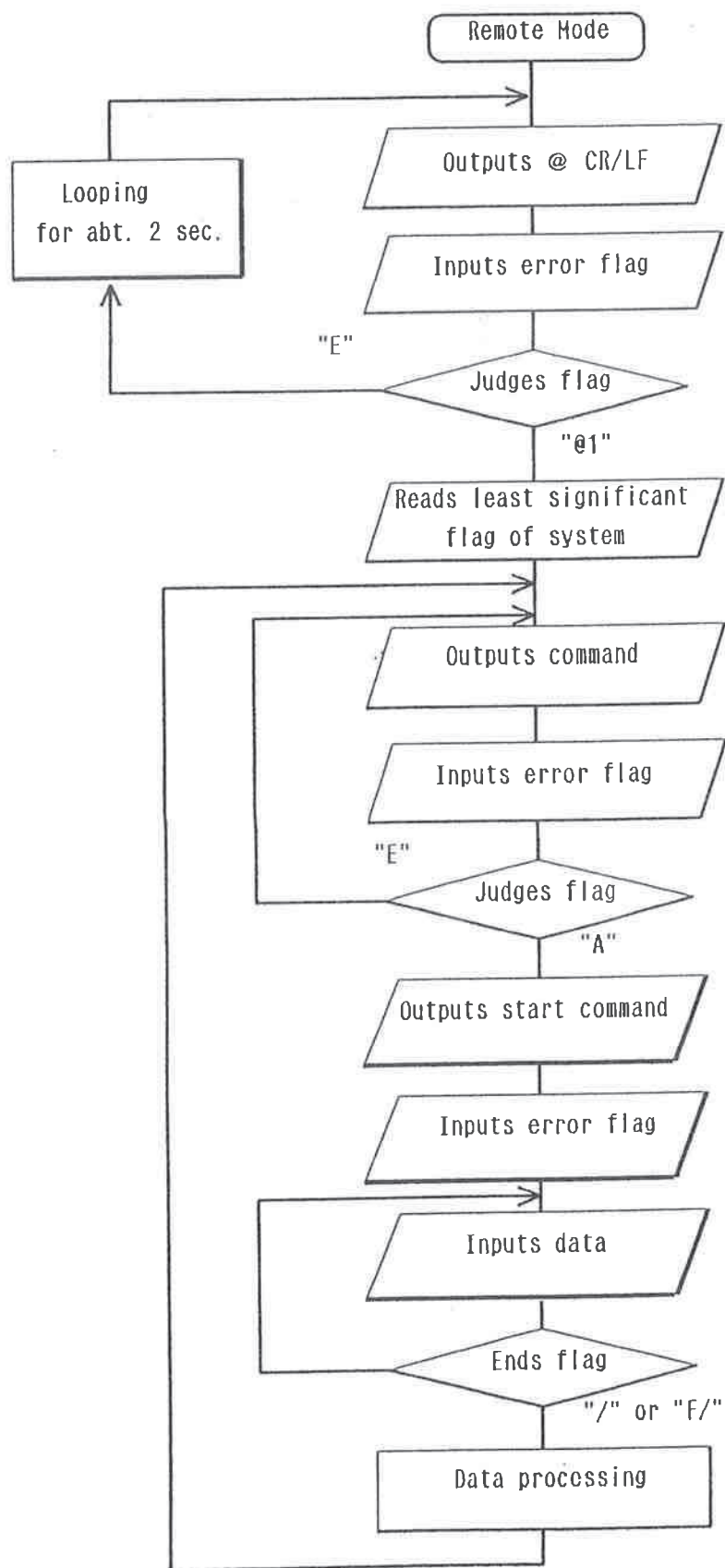

# EXAMPLE OF PROGRAM TO TAKE DATA

N88BASIC

100 OPEN "COM1:N81" AS #1	Open command
110 A\$="@" :GOx UB 230 120 GOSUB 280 130 A\$="B" :GOSUB 230 140 A\$="S" :GOSUB 230	Selects the remote mode  Selects the burst mode Starting measurement
150 GOSUB 280 :C\$=AA\$ 160 GOSUB 280 :D\$=AA\$ 170 GOSUB 280 :E\$=AA\$	Data ( 1 to 32 Channels) DATA ( 33 to 64 channels) /
180 PRINT "C\$=" ;C\$ 190 PRINT "D\$=" ;D\$ 200 PRINT "E\$=" ;E\$	Data ( 1 to 32 Channels) DATA ( 33 to 64 channels) /
210 CLOSE #1 220 END	Close command
230 ** SUBROUTINE COMMAD TRANSMISSION * 240 PRINT #1, A\$ 250 GOSUB 280 260 IF AA\$="E" THEN GOTO 220 270 RETURN	
280 ** SUBROUTIN INPUT A LINE ** 290 AA\$="" 300 B\$=INPUT\$(1,1) 310 IF B\$="" THEN GOTO 220 320 IF B\$=CHR\$(13) THEN GOTO 360 330 IF B\$=CHR\$(10) THEN GOTO 300 340 AA\$=AA\$+B\$ 350 GOTO 300 360 RETURN	

MEMO

A large rectangular area with a solid border, containing 25 horizontal dotted lines for writing.

# TABLE OF CONTENTS-CHAPTER 5

## OPTIONS

◆ ANALOG OUTPUT .....	4 6
◆ CASCADE CONNECTION .....	5 0
(Extended RS-232C)	
◆ GP-IB INTERFACE .....	5 1

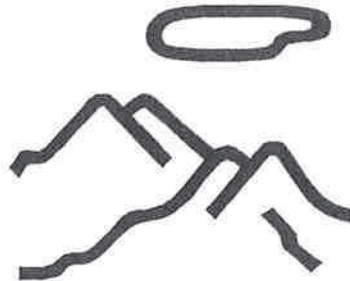



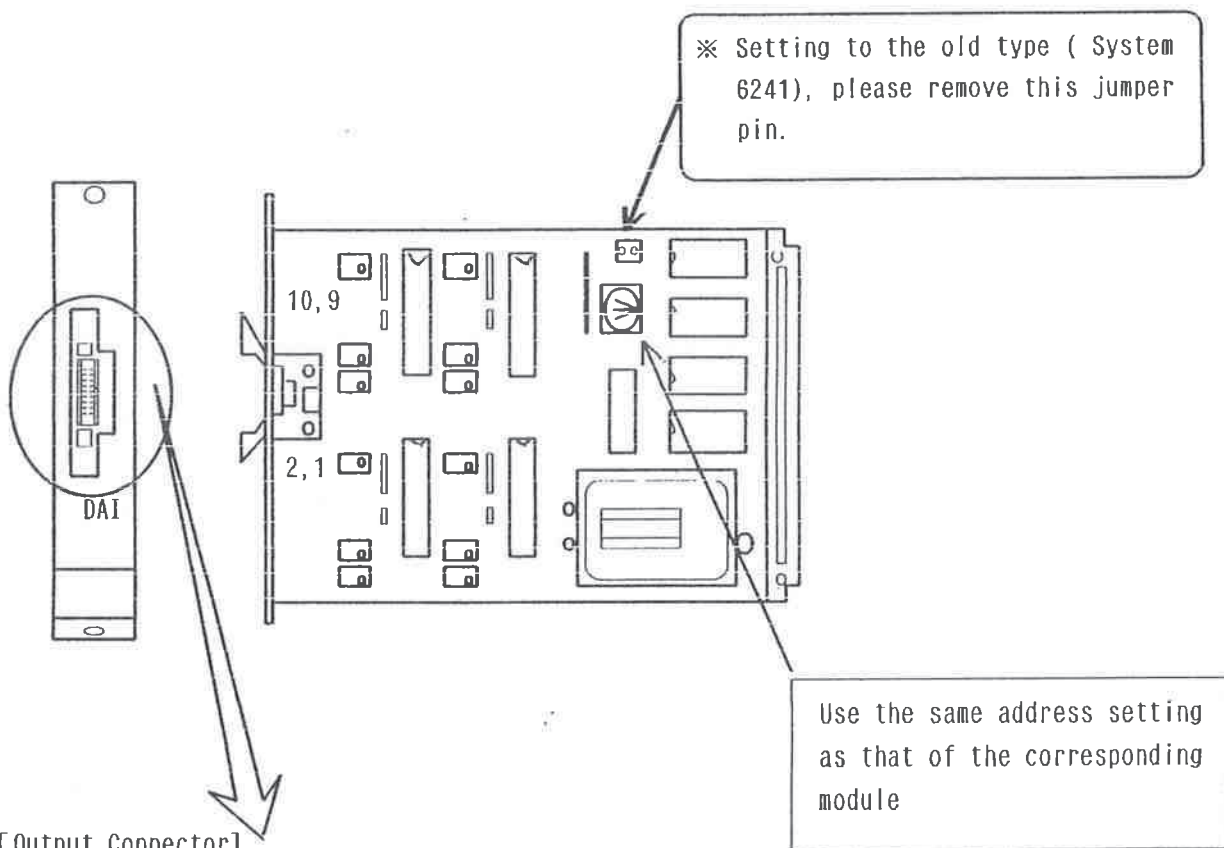

[Output Connector]

PIN NO	SIGNAL		PIN NO	SIGNAL	
1	CH 1	OUTPUT	2	CH 1	GND
3	CH 2		4	CH 2	
5	CH 3		6	CH 3	
7	CH 4		8	CH 4	
9	NC		10	NC	

[Output Cable]

PIN NO	Cable color		SIGNAL	
1	Upper	Red	CH 1	OUTPUT
	Lower	Black		GND
2	Upper	White	CH 2	OUTPUT
	Lower	Green		GND
3	Upper	Red	CH 3	OUTPUT
	Lower	Black		GND
4	Upper	White	CH 4	OUTPUT
	Lower	Green		GND

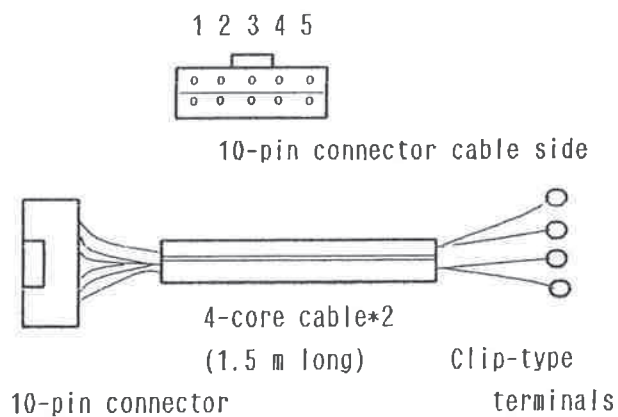

Addressing

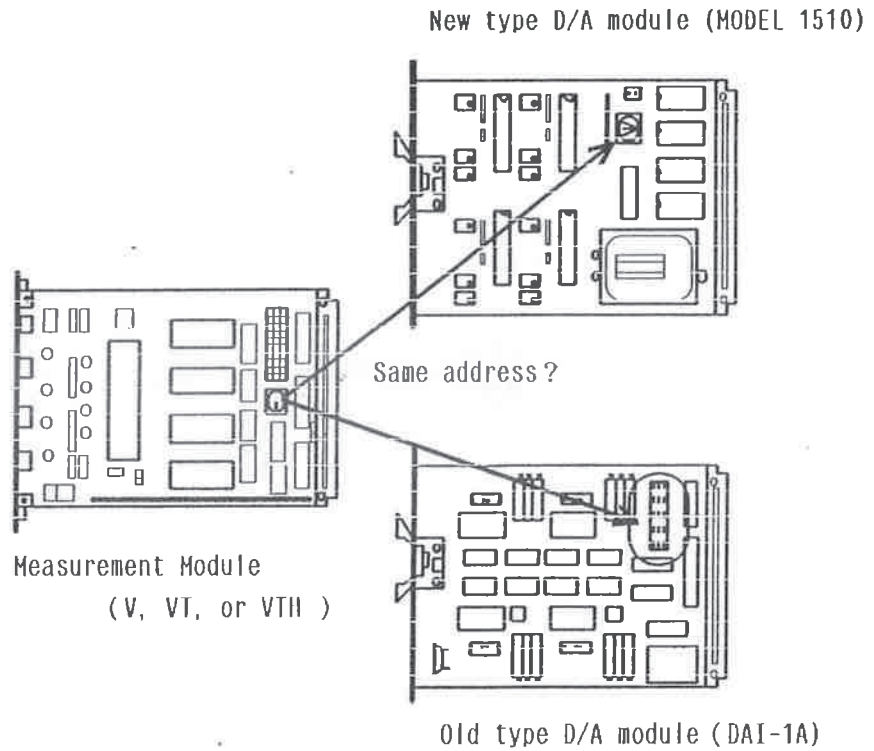

[Using the old type analog module (Model DAI-1A) ]

- ◆Prior to mounting the analog modules, be sure to address them. Never operate other jumper pins than those for addressing.
- ◆The addressing jumper pins(A7 ~A15) are fixed. So never operate them.

	Addressing (Use the same addresses as those of the measuring module to be output.)																Jumper pins	
	0	1	2	3	4	5	6	7	8	9	A	B	C	D	E	F	1	0
A 15	Fixed (A15 ~A12, A10 ... 1    A11, A9 ~A7... 0)																○	○
A 14																	○	○
A 13	Fixed (A15 ~A12, A10 ... 1    A11, A9 ~A7... 0)																○	○
A 12																	○	○
A 11	○	○	○	○	○	○	○	○	○	○	○	○	○	○	○	○	○	○
A 10	○	○	○	○	○	○	○	○	○	○	○	○	○	○	○	○	○	○
A 9	○	○	○	○	○	○	○	○	○	○	○	○	○	○	○	○	○	○
A 8	○	○	○	○	○	○	○	○	○	○	○	○	○	○	○	○	○	○
A 7	○	○	○	○	○	○	○	○	○	○	○	○	○	○	○	○	○	○
A 6	○	○	○	○	○	○	○	○	○	○	○	○	○	○	○	○	○	○
A 5	○	○	○	○	○	○	○	○	○	○	○	○	○	○	○	○	○	○
A 4	○	○	○	○	○	○	○	○	○	○	○	○	○	○	○	○	○	○
A 3	○	○	○	○	○	○	○	○	○	○	○	○	○	○	○	○	○	○

[ Ex. ] Analog module...M-03 (Address ...02)

Setting the output range

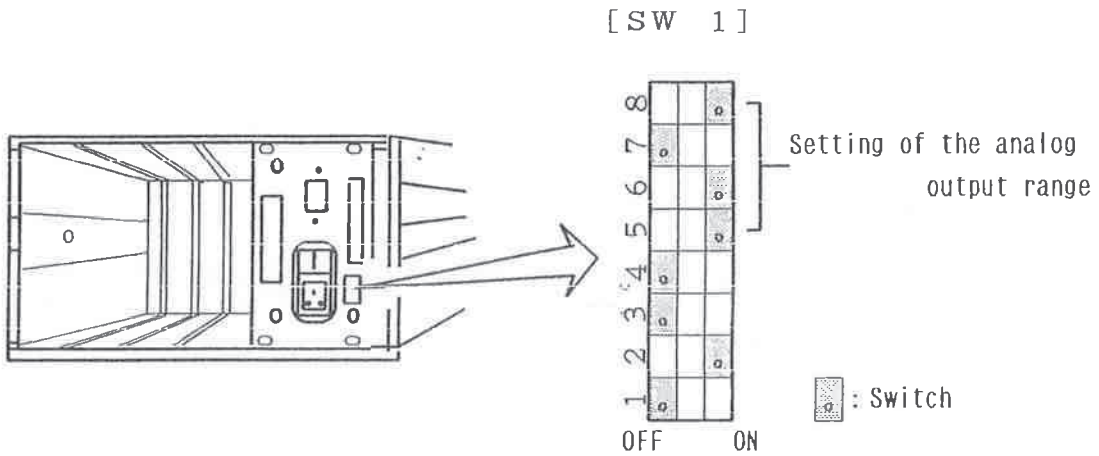

Air velocity range	SW 1	
	5	6
0 ~ 2 m/s	OFF	OFF
0 ~ 10 m/s	ON	OFF
0 ~ 25 m/s	OFF	ON
0 ~ 50 m/s	ON	ON

◆Set at the range of 0 ~ 50 m/s before delivery

temperature range	SW 1	
	7	8
0 ~ 500 °C	OFF	OFF
0 ~ 200 °C	ON	OFF
0 ~ 100 °C	OFF	ON
-50 ~ 50 °C	ON	ON

◆Set at the range of 0 ~ 100 °C before delivery

◆Output voltage...Outputs 0 ~ 5V linearly for each set range as can be seen from the following example.

[EX.] ... For the air velocity range of 0~10 m/s, 0V forexample is output for 0 m/s and 5V for 10 m/s on a linear basis.

◆Resolution.....Is indicated with respect to full scale in voltage per m/s.

[EX.] ...Range 0 ~ 2 m/s :  $5V / 200 = 25\text{mV} / \text{cm/s}$   
 Range 0 ~ 10 m/s :  $5V / 1000 = 5\text{mV} / \text{cm/s}$   
 Range 0 ~ 50 m/s :  $5v / 5000 = 1\text{mV} / \text{cm/s}$

(However, in order to accommodate display resolution, the resolution for air velocities of more than 10 m/s will be indicated on the basis of 10mV / 10cm/s.

◆Conversion rate ...Constantly outputs data for each channel every 0.1 second.

Other Precautions

※The measurement modules and analog modules are the same in quantity.

※Max. number of modules that can be mounted in a single.

System 6242: 8 modules  
System 6243: 16 modules

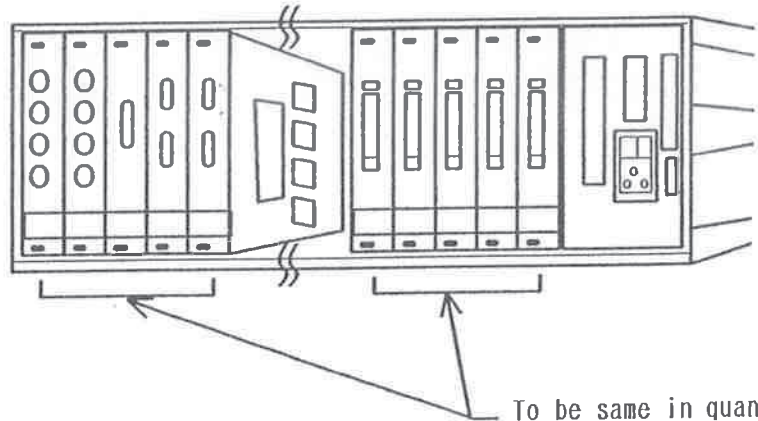
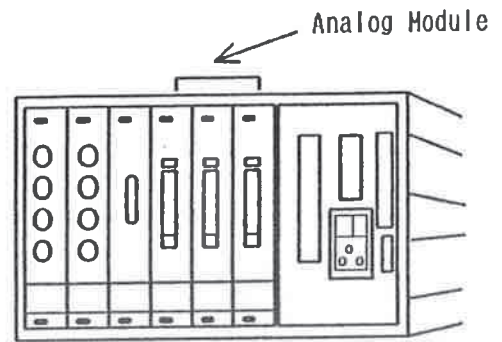

[Output of Each Channel]

	V	VT	VTH
CH 1	V1	V1	V
2	V2	T1	I
3	V3	V2	H
4	V4	T2	*

For the module VTH, Channel 4 has an output of 0V.

MEMO

---

---

---

---

---

---

---

---

---

---

# CASCADE CONNECTION (Extended RS-232C )

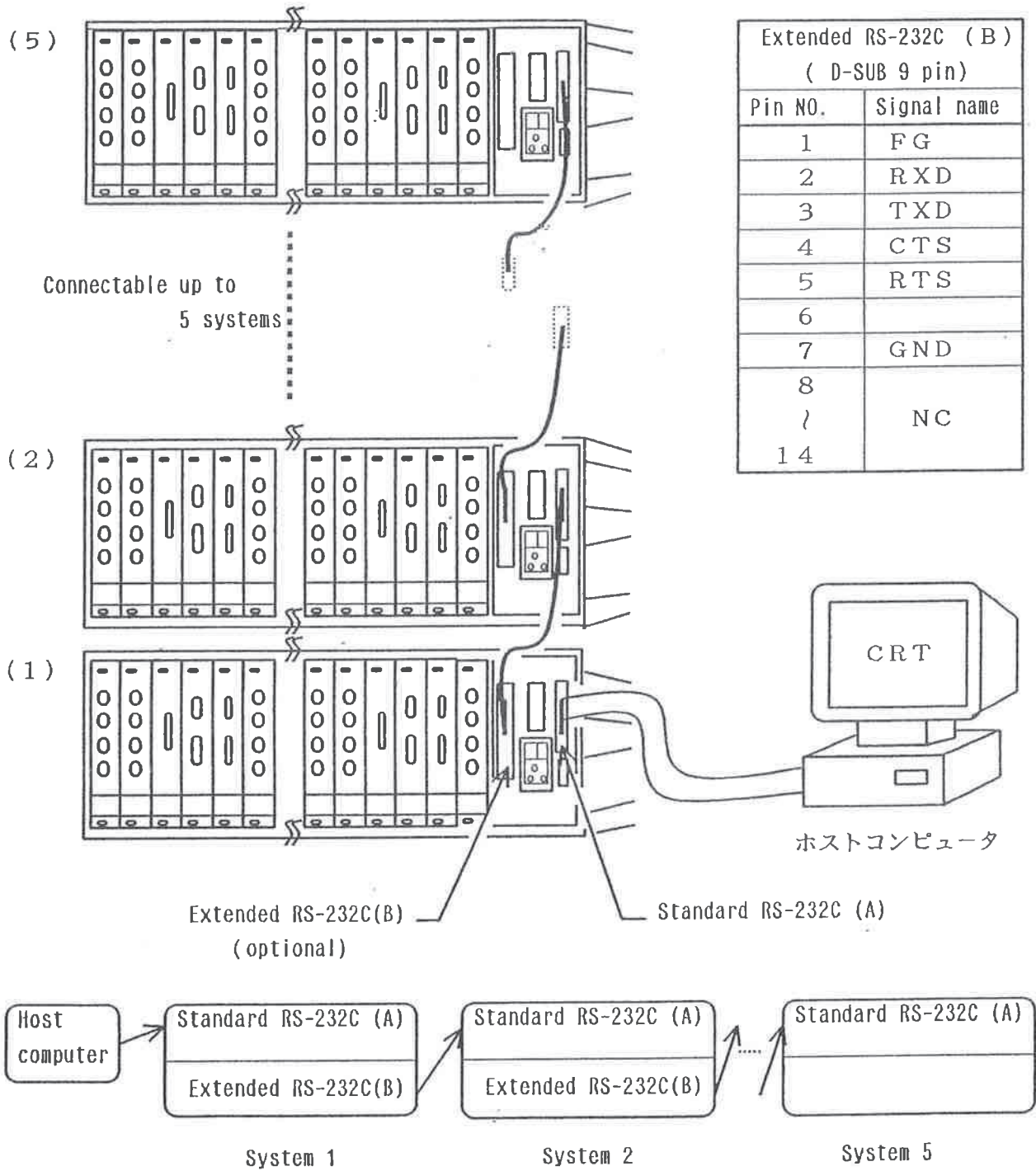

※ Sampling conditions (such as sampling interval) applicable during data transmission are the same irrespective of the number of systems connected.

※ In place of an extended RS-232C, GP-IB(optional) can also be mounted. So, either of them should be selected. For information about the GP-IB, see the following.



# GP-IB INTERFACE (Either GP-IB or extended RS-232C should be selected.)

(N)

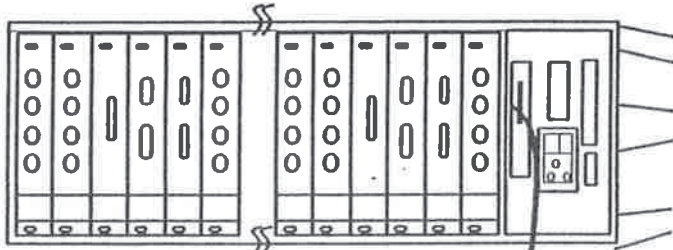

◆ When connecting two or more systems together, connect them as shown in the figure below.

(2)

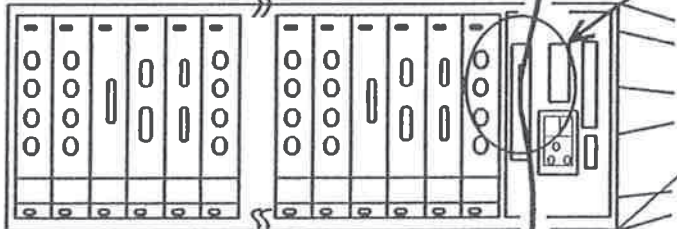

(1)

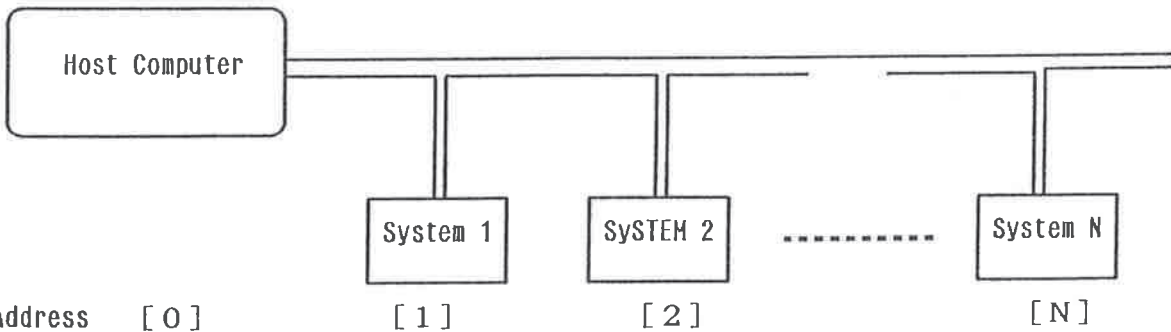
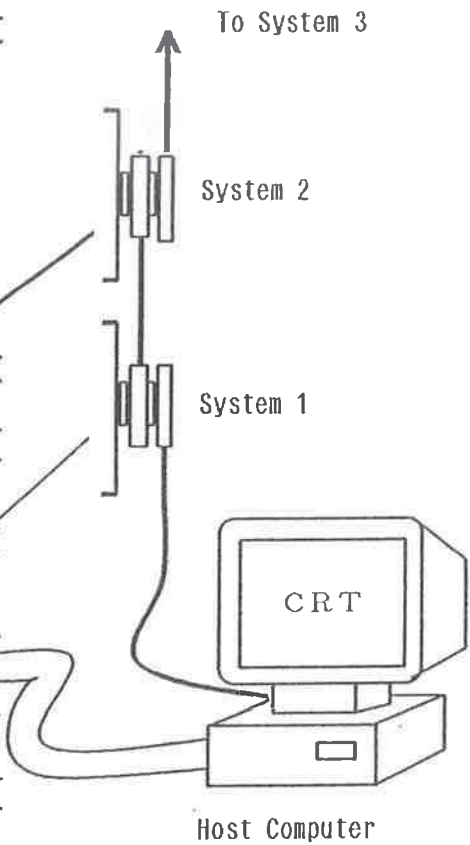
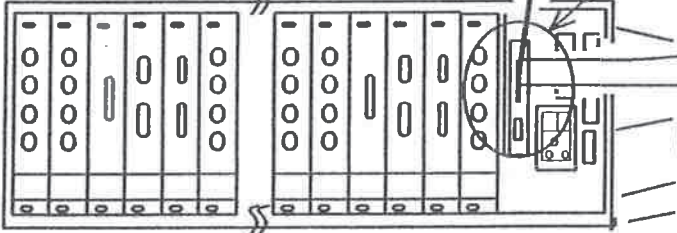

※It is necessary to address each connected system. Calling a specific system NO. transfers its data to the host computer.



Output Connector

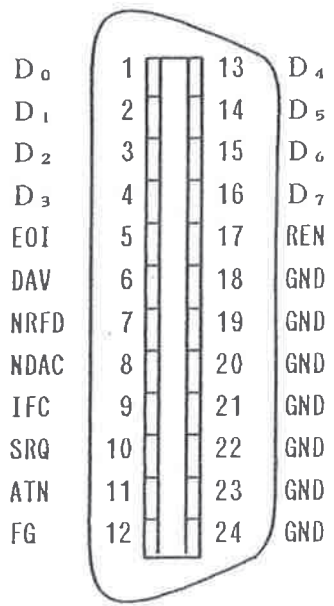

GP-IB  
(SW2)

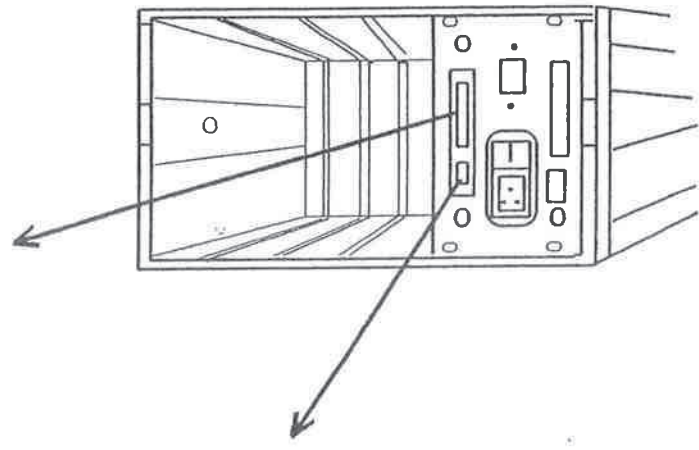

[SW 2] --- Addressing Switch

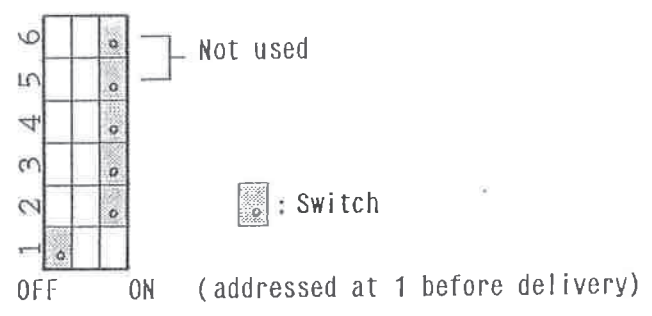

Addressing

Address	SW 2			
	1	2	3	4
* 0	ON	ON	ON	ON
1	OFF	ON	ON	ON
2	ON	OFF	ON	ON
3	OFF	OFF	ON	ON
4	ON	ON	OFF	ON
5	OFF	ON	OFF	ON
6	ON	OFF	OFF	ON
7	OFF	OFF	OFF	ON

Address	SW 2			
	1	2	3	4
8	ON	ON	ON	OFF
9	OFF	ON	ON	OFF
10	ON	OFF	ON	OFF
11	OFF	OFF	ON	OFF
12	ON	ON	OFF	OFF
13	OFF	ON	OFF	OFF
14	ON	OFF	OFF	OFF
15	OFF	OFF	OFF	OFF

Note: As the address " 0 " is often already set at a host computer, do not use it in the systems ( 6242/6243 ) .

- ◆ Basically these commands are the same as those of output format and the commands for RS-232C. In addition to them these are also the following commands peculiar to the GP-IB.

Added Commands	
P (CR/LF)	Returns an SRQ command upon completion of measurement after the command "S" (measurement start) is received.
G (CR/LF)	Putting the system in the G mode returns no SRQ command even after the measurement is completed.
<p>※ In general the G mode and the P mode are respectively used for short and long sampling intervals. Each time a single measurement is completed, an SRQ command is received to allow the system to wait for the next measurement process.</p> <p>※ When power is turned on, the system is put in the P mode.</p>	
Y (CR/LF)	<p>Channel Mode : Clears the command TAD (talker address) each time data for one channel is sent.</p> <p>Burst Mode : Clears TAD every 32 channels.</p>
T (CR/LF)	Does not clear TAD irrespective of communication mode (channel mode or burst mode), but retains this TAD command until IFC, UNT or MLA is received.
<p>※ A TAD command must be sent each time the system reads data for one channel when in the channel mode, or data for 32 channels when in the burst mode.</p> <p>※ After power is turned on, the system is in the Y mode.</p>	

### Change of Error Frag(Return Code)

On GP-IB interface, error codes "@1", "@X", "E", "A" of RS-232C interface are not returned. Instead of that, SQR is sent out and it transmits an occurrence of an error to controller. "/"(completing transmission of data measured) and "F"(Memory-Full) are returned to data line as a return code.

### Occurrence of SRQ

In case of the following 3 conditions, this system send out SRQ.

- (1) When this unit receives a command "@", and becomes remote controlled.
- (2) When a command received has a grammatical error.
- (3) When measurement is started with an effective command "P", and data measured is possible to be sent out.

After received SRQ, controller carry out serial poll, and receive status byte from this system. The following table is the content of status byte.

[Status byte]

7	6	5	4	3	2	1	0
---	SRQ	---	---	---	Grammatical Error	REMOTE	DATA measured available

10	! *****	
20	! *****	
30	! *	*
40	! * MULTI-ANEMOMASTER SAMPLING TEST PROGRAM ( BURST MODE )	*
50	! *	*
60	! * LANGUAGE : BASIC Ver 5.1	*
70	! * MACHINE : HP9000-300 ( 98581AJ )	*
80	! * : KANOMAX SYSTEM 6242/6243 (GP-IB INTERFACE )	*
90	! *	*
100	! *****	
110	! *****	
120	! *****	
130	! / INITIALIZE /	
140	OPTION BASE 0	
150	DIM Dat(1,64), Bdat1\$(128), Bdat2\$(128), Bdat\$(256), Dm\$(2)	
160	ASSIGN @Anemo TO 702	; SETTING ADDRESS
170	Total_no=1	; TOTAL UNIT NUMBER
180	Unit_no=0	; ACTIVE UNIT NUMBER
190	Sens_no=0	; ACTIVE CH NUMBER
200	!	
210	! / REMOTE /	
220	OUTPUT @Anemo;"@",END	; SETTING REMOTE MODE
230	WAIT 1	
240	OUTPUT @Anemo;"G",END	; <SRQ> NO REQUEST
250	WAIT 1	
260	OUTPUT @Anemo;"B",END	; SETTING BURST MODE
270	WAIT 1	
280	OUTPUT @Anemo;"S",END	; SAMPLING START
290	WAIT 1	
300	!	
310	! / SAMPLING /	
320	FOR Unit_no=1 to Total_no	
330	PRINT "UNIT No.=";Unit_no	; DISPLAY OF ACT.UNIT.NO.
340	Bdat1\$=""	; BUFFER 1 IS EMPTY
350	Bdat2\$=""	; BUFFER 2 IS EMPTY
360	ENTER @Anemo;Bdat1\$	; CH 1-32 DATA
370	WAIT 1	(DDDD*32)CR
380	PRINT Bdat1\$	
390	ENTER @Anemo;Bdat2\$	; CH 33-64 DATA
400	WAIT 1	(DDDD*32)CR
410	PRINT Bdat2\$	
420	Bdat\$=Bdat1\$&Bdat2\$	; CH DATA 1 ~64CH
430	FOR Sens_no=1 To 64	
440	Cdat\$=Bdat\$[(Sens_no-1)*4+1,Sens_no*4]	; PICK UP DATA OF A CH
450	Dat(Unit_no,sense_no)=VAL(Cdat\$)/100	; STORE DATA
460	PRINT USING "#, DD. DD";Dat(Unit_no,Sens_no)	; DISPLAY OF DATA
470	PRINT " ";	
480	IF (Sens_no MOD 8 )=0 THEN PRINT " "	
490	Next Sens_no	
500	PRINT " "	
510	NEXT Unit_no	
520	ENTER @Anemo;Dm\$	; RECEIVE DATA END CODE
530	WAIT 1	
540	!	
550	! / LOCAL /	
560	OUTPUT @Anemo;"L",END	
570	WAIT 3	
580	END	
590	!	

<pre> 10      !      * * * * * 20      ! 30      !      * 40      !      *   MULTI-ANEMOMASTER SAMPLING TEST PROGRAM ( BURST MODE ) 50      !      * 60      !      *   LANGUAGE : BASIC Ver 5.1 70      !      *   MACHINE   : HP9000-300 ( 98581AJ ) 80      !      *           : KANOMAX SYSTEM 6242/6243 (GP-IB INTERFACE ) 90      !      * 100     ! 110     !      * * * * * 120     ! </pre>	
<pre> 130     ! / INITIALIZE / 140     OPTION BASE 0 150     ON INTR 7 GOSUB Sspol 160     Mask=2 170     ENABLE INTR 7;Mask 180     DIM Bdat\$(200) 190     ASSIGN @Anemo TO 702 </pre>	<pre> ; SRQ ROUTIN ; Bit 1 enablees SRQ interrupts  ; SETTING OF ADDRESS </pre>
<pre> 200     ! / Loop / 210     OUTPUT @Anemo;"@",END 220     WAIT 1 230     Loop; ! 240     DISP "** " 250     DISP "  **" 260     GOTO Loop 270     ! </pre>	<pre> ; SETTING OF REMOTE MODE  ; USER PROGRAM </pre>
<pre> 280     ! 290     Sspol; ! 300     S=SPOLL(@Anemo) 310     BEEP 320     IF BIT(S,0)=1 THEN 330         ENTER @Anemo;Bdat\$ 340         PRINT Bdat\$ 350         IF Bdat\$[1,1]="/" THEN Sampend 360     ELSE 370         IF BIT(S,1)=1 THEN 380             PRINT "REMOTE ON" 390             OUTPUT @Anemo;"R10;I40",END 400             WAIT 1 410             OUTPUT @Anemo;"S",END 420         ELSE 430             PRINT "ERROR" 440         END IF 450     END IF 460     ENABLE INTR 7 470     RETURN </pre>	<pre> ; DATA READ FROM 6240  ; CHECK SAMPLING END  ; SETTING MEASURING MODE ; SAMPLING START 10times 4sec </pre>
<pre> 480     Sampend; ! 490     PRINT "SAMPLING END" 500     OUTPUT @Anemo;"L",END 510     END 520     ! </pre>	

# TABLE OF CONTENTS-CHAPTER 6

OTHERS

◆ SYSTEM SPECIFICATIONS .....	5 8
◆ PROBE SPECIFICATIONS .....	6 0
◆ TROUBLESHOOTING .....	6 1
◆ WARRANTY AND AFTER-SALE SERVICE OF PRODUCT .....	6 2





# SYSTEM SPECIFICATIONS

Product Name	Multichannel Anemomaster(SYSTEM 6242/6243)												
Model	MODEL 1550 ( 1/1 case ) MODEL 1560 ( 1/2 case )  Measurement Modules												
	<table border="1"> <thead> <tr> <th>Module Name</th> <th>NO. of channels</th> <th>Model</th> </tr> </thead> <tbody> <tr> <td>Module V</td> <td>4 channels ( in total)</td> <td>1 5 0 4</td> </tr> <tr> <td>Module VT</td> <td>2 channels ( 2 channels each)</td> <td>1 5 1 1</td> </tr> <tr> <td>Module VTH</td> <td>1 channel ( 1 channel each)</td> <td>1 5 1 2</td> </tr> </tbody> </table>	Module Name	NO. of channels	Model	Module V	4 channels ( in total)	1 5 0 4	Module VT	2 channels ( 2 channels each)	1 5 1 1	Module VTH	1 channel ( 1 channel each)	1 5 1 2
Module Name	NO. of channels	Model											
Module V	4 channels ( in total)	1 5 0 4											
Module VT	2 channels ( 2 channels each)	1 5 1 1											
Module VTH	1 channel ( 1 channel each)	1 5 1 2											
Object to be measured	Clean air flow at atmospheric pressure and normal humidity												
Display resolution	<table border="1"> <thead> <tr> <th>air velocity</th> <th>air temperature</th> <th>relative humidity</th> </tr> </thead> <tbody> <tr> <td>0~9.99 m/s.....0.01m/s</td> <td rowspan="2">0.1℃</td> <td rowspan="2">0.1%RH</td> </tr> <tr> <td>10.0m/s 以上.....0.1 m/s</td> </tr> </tbody> </table>	air velocity	air temperature	relative humidity	0~9.99 m/s.....0.01m/s	0.1℃	0.1%RH	10.0m/s 以上.....0.1 m/s					
air velocity	air temperature	relative humidity											
0~9.99 m/s.....0.01m/s	0.1℃	0.1%RH											
10.0m/s 以上.....0.1 m/s													
Display	LCD( with backlight) Displays on a module basis Module V simultaneously displays an air velocity for each channel.  Module VT simultaneously displays an air velocity on Channels 1 and 3, and an air temperature on Channels 2 and 4 respectively.  Module VTH simultaneously displays an air velocity on Channel 1, an air temperature on Channel 2 and a humidity on channel 3.												
Function	◆Display: MAN: Is used to select modules by operating the UP/DOWN switches and to display data on a module basis. AUTO: Automatically selects modules every 2 seconds to display data.  ◆Measurement Mode: Burst Mode: Transfers data of all channels at high speed. Channel Mode:Transfers data of the specified channel only.												

◆Data Selection:

Instantaneous value mode: Outputs instantaneous values every specified sampling time, and outputs the average value.

※ "REHOTE" is displayed during data transmission, with no data displayed.

※ NO. of repetitions : 1 to 65,535

※ Sampling interval : 0.1\*T(sec) ( T; 1 ~ 65,535 )

◆Printing:

In the display mode, the system prints data that is displayed every 2 seconds.

In the AUTO mode, the system automatically prints data subsequently on a module basis.

In the MAN mode, the system prints data only of the module displayed, every 2 seconds.

Interface

◆Data transfer : RS-232C (standard), extended RS-232C (optional) and GP-IB (optional)  
( to be cascade-connected)

◆Boud Rate : 300,600,1200,2400,4800,9600,19200 bps (selectable)

◆Printer output : Centronics

Operating temperature range

5~40°C

Outside dimensions

MODEL 1550 : 430(W)×140(h)×500(d)mm

MODEL 1560 : 226(W)×140(h)×325(d)mm

Weight

MODEL 1550 : approx. 10 Kg

MODEL 1560 : approx. 5 Kg

Power supply

AC 100 V 50/60 Hz (4A)

Standard accessories

RS-232C cable (1.5 m long)	1 pc.
Printer cable (1.5 m long)	1 pc.
Power cable (1.5 m long)	1 pc.
Instruction manual	1 copy
Fuse	2 pcs.

Options

Blank panel
Analog output module
Probe cable
Rack mounting angle
RS-232C interface for cascade connection (with 1.5 m long cable)
GP-IB interface (with 1.5 m long cable)

# PRPBE SPECIFICATIONS

Measurement Range and Accuracy	[Air Velocity Probe]		
	MODEL 0962-00	0.1 ~ 4.99 m/s : ±0.1 m/s	
	0963-00	5.00 ~ 9.99 m/s : ±0.2 m/s	
		10.0 ~ 24.9 m/s : ±0.5 m/s	
		25.0 ~ 50.0 m/s : ±1.0 m/s	
	MODEL 0964-01	0.1 ~ 4.99 m/s : ±0.15 m/s	Horizontal characteristics; ±5% F.S.
	-02	5.00 ~ 9.99 m/s : ±0.3 m/s	
		10.0 ~ 24.9 m/s : ±0.75 m/s	
		25.0 ~ 50.0 m/s : ±1.5 m/s	
	MODEL 0965-00	0.1 ~ 4.99 m/s : ±0.15 m/s	
-03	5.00 ~ 9.99 m/s : ±0.3 m/s		
-04	10.0 ~ 25.0 m/s : ±0.60 m/s		
-07	Horizontal characteristics; ±3% F.S.		
-08	Vertical characteristics; ±3% F.S. (elevation angle 0 ~ ±40°) ---only for Model 0965-00 Vertical characteristics; ±3% F.S. (elevation angle 0 ~ ±20°) ---only for Model 0965-03, -04, -07, -08		
	[Air velocity / temperature probe]		
	Air Velocity	Air Temperature	
MODEL 0965-21	Compatible with type 0965-03	Range: 0 ~ 100 °C Accuracy: ±1 °C	
MODEL 0962-21	Compatible with type 0962		
MODEL 0963-21	Compatible with type 0963		
	[Air Velocity, temperature & humidity probe]		
	Air velocity	Air Temperature	Relative Humidity
MODEL 0963-31	Compatible with type 0963	Range: 0 ~ 60 °C	Range: 5 ~ 95%RH
MODEL 0965-31	Compatible with type 0965-03	Accuracy: ±1 °C	Accuracy : 5 ~ 80%RH ... ±3%RH 80 ~ 95%RH ... ±5%RH
Response	「90% at air velocity of 1 m/s」 Type 0962/0963.....approx. 1 second Type 0964 .....approx. 3 second Type 0965 .....approx. 7 second		
Temperature compensation accuracy	5 ~ 40 °C.....±5 % F.S. 40 ~ 80 °C.....±7 % F.S.		

# TROUBLESHOOTING

(1) The system cannot be powered on. ....☞ Check the fuses.

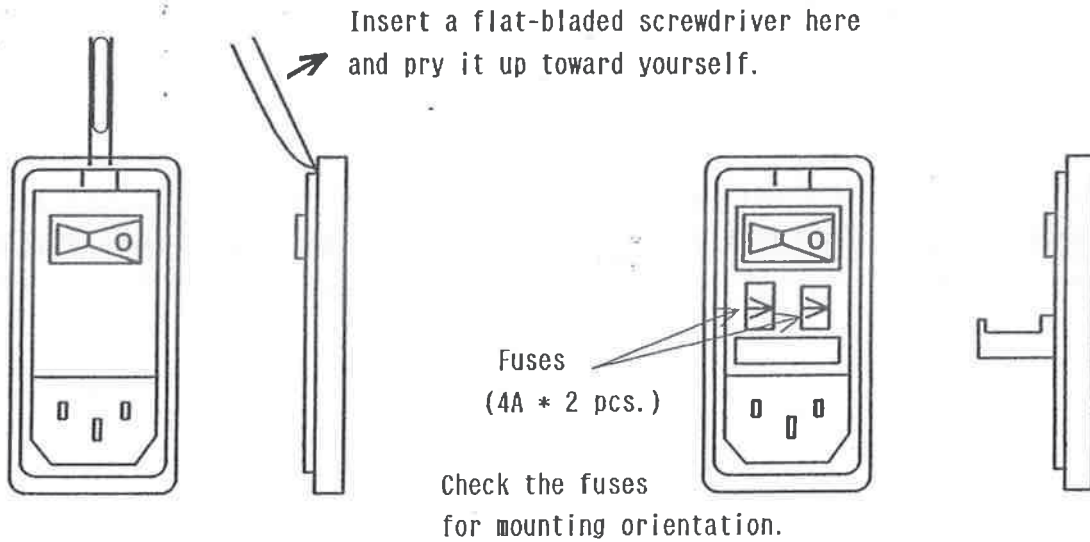

\*Pull out both fuses to check for wire breakage.  
When mounting them again, pay attention to orientation.

(2) The display screen remains to show "000" or "\*\*\*".

- ◆ Probe is not connected. ....connect probe. ☞ Page 11
- ◆ Characteristic ROM is not mounted. ....Check modules ☞ Page 8
- ◆ Probe wire is broken. .... Replace with a new one.

(3) Data of a certain module is not displayed.

- ◆ Modules have the same address.  
☞ Page 9

(4) Dispersion of measured values is significant.

- ◆ Is the characteristic ROM NO. in agreement with the probe NO. ?  
☞ Page 11

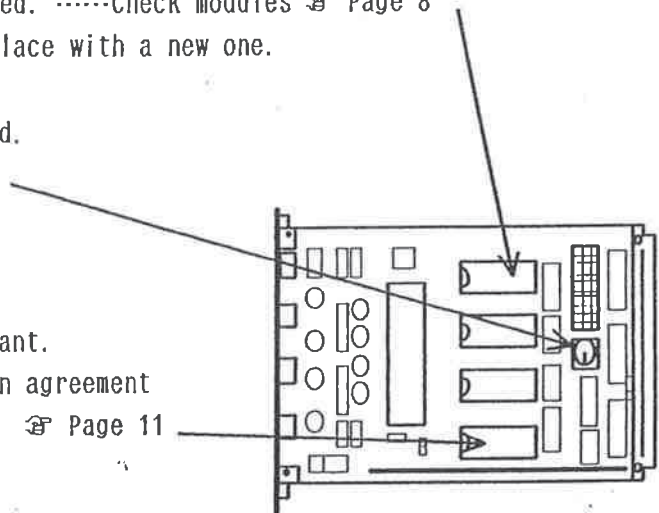

(5) No communication can be attained.

- ◆ Check the system for output format, data format and commands again.

# WARRANTY AND AFTER-SALE SERVICE OF THE PRODUCT

---

## Product Warranty

- ◆ We issue no product warranty card.
- ◆ The product comes with a registration card. Please be sure to receive it when you purchase the Product, and fill it out as required therein and send it back to us for our warranty control. Failure to do so may result in loss of warranty for the product.
- ◆ The guarantee period shall in principle be 12 months after the date of purchase, but shall not cover accessories and consumable items including cables.

## After-sale Service

- ◆ Whenever the product is malfunctioning, first check it in accordance with "Troubleshooting" to locate the causes.
- ◆ Repairs applicable in the guarantee period  
If the functions and/or measuring accuracy of the product can be restored by repairs, we make necessary repairs on request on a customer's account.
- ◆ Storage period of repair spares  
Repair parts are retained for a minimum period of five years after production cessation. This storage period of repair parts is handled as the period during which we can provide repair services. For consultation about details, please contact our service center and at the same time, furnish us with the following information.

Product name	: Multichannel Anemomaster
Model NO.	: 6242/6243/1504, etc.
Serial NO.	:
Faulty item(s)	: System (proper), modules, probes
Symptom	: to be detailed as much as possible.
Data of purchase:	

