



FOR SAFETY MEASUREMENTS

Prior to use, to avoid an electrical shock hazard to the operator and/or damage to the instruments, read carefully the WARNINGS with the symbol  marked on the Clamp Meter and listed in 「4. SAFETY PRECAUTIONS」, 「5. MEASUREMENT PROCEDURES」 and 「6. MAINTENANCE」 of this instruction manual.

Important Symbol

: The symbol listed in IEC 61010-1 and ISO 3864 means "Caution (refer to instruction manual)".

 **WARNING** : The symbol in this manual advises the user of an electrical shock hazard that could result in serious injury or even death.

 **CAUTION** : The symbol in this manual advises the user of an electrical shock hazard that could cause injury or material damages.

WARNING

High Power Line is very dangerous and/or lethal to measure. High Power Line sometimes includes High Surge Voltage that could possibly induce dangerous arcs of explosive short in the instrument and could result in serious injury to the operator. When measuring dangerous voltages of High Power Line or High Voltage Circuit, always place the instrument away from your body without holding it with your hand.

Do not touch the Clamp Meter, its Test Leads, or any part of the circuit while it is on.

CONTENTS

1. INTRODUCTION	2
1-1. GENERAL	2
1-2. FEATURES	2
1-3. UNPACKING AND INSPECTION	2
2. SPECIFICATIONS	3
2-1. GENERAL SPECIFICATIONS	3
2-2. SK-7708 MEASUREMENT SPECIFICATIONS	5
3. NAME ILLUSTRATION	8
4. SAFETY PRECAUTIONS	16
4-1. WARNINGS FOR MEASUREMENTS	16
4-2. CAUTIONS IN HANDLING	20
5. MEASUREMENT PROCEDURES	21
5-1. PREPARATION FOR USE	21
5-2. \bar{A} · Hz / \tilde{A} · Hz (≈ 2000A) MEASUREMENTS	23
5-3. \bar{V} · Hz · % / \tilde{V} · Hz · % (≈ 600V) MEASUREMENTS	26
5-4. Ω (40M Ω) MEASUREMENTS	27
5-5. \bullet (CONTINUITY) TESTS	29
5-6. \rightarrow (DIODE) TESTS	29
5-7. \dashv (CAPACITANCE) MEASUREMENTS	31
6. MAINTENANCE	33
6-1. WARRANTY STATEMENT	33
6-2. BATTERY REPLACEMENT	33
6-3. PERIODICAL CHECK AND CALIBRATION	34
6-4. REPAIR	35

— 1 —

1. INTRODUCTION

1-1. GENERAL

The Model SK-7707/7708 is the most advanced, popular AC/DC Digital Clamp Meter that is micro-computer controlled, and presents circular measurements. It is rugged, versatile, handheld instrument that offers many useful, original functions and operations like following features. Therefore, it is very useful for testing and maintaining multifarious electric appliances/apparatus and equipments/facilities. It is also designed with usability in mind for checking electric systems of motorcars. The models are reliable and tough instruments that ensure accurate measurements for every purpose.

1-2. FEATURES

1. Capable of measuring Frequency in Current measurement and Frequency and Duty Cycle in Voltage measurement.
2. \sim / \equiv Current, Voltage, Resistance, Continuity, Diode and Capacitance measurements are available.
3. Capable of storing Maximum and Minimum Values.
4. Peak Hold (at 10m sec, SK-7708 only), Difference, Range Hold and Display Hold functions are available.
5. Body cases are of Dust-proof and Water-resistant structure to protect inside components from pollution and very tough made of Heat-resistant ABS.
6. CE mark is authorized complied with LVD (IEC 61010-1) and EMC. CAT.Ⅲ 600V.
7. Provided with Auto Power Save function to save battery energy.

1-3. UNPACKING AND INSPECTION

Before unpacking, examine the shipping carton for any sign of damage. Unpack and inspect the instrument and accessories for any damage from mechanical shock, water leakage, or other causes. If any damage or missing item is found, consult the local dealer for replacement.

— 2 —

Make certain that following items are included in the box.

1. Digital Clamp Meter
2. One pair of Test Leads (100-57 complies with IEC spec.)
3. One 9V 6F22 Battery
4. Instruction Manual
5. 1007 Carrying Case

2. SPECIFICATIONS

2-1. GENERAL SPECIFICATIONS

1. DISPLAY :

a. **Numerical Display** : 4000 count LCD, Max 5120, 14mm High.

b. **Units and Symbols** : A, mV, V, Hz, kHz, %, Ω , k Ω , M Ω , nF, μ F, BAT, AUTO, PH (SK-7708), \dashv |, \bullet ||, \rightarrow |, DH, DIFF, MAX, MIN, APS, \equiv , \sim and decimal point.

2. OPERATING PRINCIPLE : Σ Δ Conversion.

3. **MEASURING PRINCIPLE** : SK-7707 : Average Rectification
SK-7708 : True RMS. AC Coupling.

4. SAMPLING RATE : 3 times/sec.

5. RANGE SELECTION : Autoranging and Manual-ranging.

6. **POLARITY** : Autopolarity, $-$ symbol when minus, $+$ symbol is implied.

7. OVERLOAD INDICATION : OL symbol is shown.

8. BATTERY WARNING : BAT symbol is shown. (less than 7.2V)

9. DISPLAY HOLD : Display is held by DH Key.

10. MAX/MIN : Max. and Min. Values are measured by MAX/MIN Key.

11. **PEAK HOLD** : a. Current ; up to \sim / \equiv 3000A peak.
(SK-7708 only) b. Peak Value is measured at 10m sec.

12. **DIFF (Difference)** : Desired value being measured is stored and converted to read zero on LCD and only difference is shown with proceeding measurements. Also use this Key to take zero on DC Current or Capacitance measurements when necessary.

13. **CONTINUITY TEST** : buzzer sounds in case less than approx. 50 Ω .

— 3 —

14. **DIODE TEST** : Good or bad is judged
15. **OVERLOAD PROTECTION** :
- a. Current ; $\overline{\sim}$ / \sim 3000A rms (600V Line) for one minute.
- b. Voltage ; $\overline{\sim}$ / \sim 1200V rms for one minute.
- c. Ω , $\overline{\sim}$, \rightarrow , \rightarrow , \rightarrow ; $\overline{\sim}$ / \sim 300V rms for one minute.
16. **DIELECTRIC STRENGTH** : 5.55 kV (Sine Wave) for one minute between Case and Input Terminals.
17. **OPERATING TEMPERATURE & HUMIDITY** : 0°C to 40°C, less than 80% RH in non-condensing.
18. **STORAGE TEMPERATURE & HUMIDITY** : -20°C to 60°C, less than 70% RH in non-condensing.
19. **TEMPERATURE COEFFICIENT** : When 0°C to 18°C and 28°C to 40°C, (Accuracy on condition of 23°C±5°C) × 0.1/ °C
20. **SAFETY LEVEL** : CE Mark authorized. (IEC 61010-1 CAT III 600V, and EMC Test passed.)
21. **POWER SUPPLY** : One 9V 6F22 (S-006P) Battery
22. **POWER CONSUMPTION** : less than 90mW, approx. 30 hours continuous operation.
23. **AUTO POWER SAVE** : LCD is automatically turned off and put into power save condition after 12 minutes of power on.
24. **CONDUCTOR DIAMETERS** : 55mm ϕ , Bus Bar 10 × 65mm, 20 × 60mm
25. **DIMENSIONS & WEIGHT** : 250(H) × 92(W) × 39(D)mm, 500g
26. **ACCESSORIES** : 100-57 Test Lead × 1 set,
1007 Carrying Case × 1,
9V 6F22 Battery × 1,
Instruction Manual
27. **OPTIONAL ACCESSORIES** : 880 Line Separator
100-41 Test Lead Kit
100-62 Test Lead Set
940 Alligator Clips
793 Coil-Type Contact Pin

- 4 -

2-2. SK-7708 MEASUREMENT SPECIFICATIONS

(23°C±5°C, less than 80% RH)

1. $\overline{\sim}$ / \sim · Hz (DC Current / AC Current · Hz)

SK-7707 : Average Rectification
SK-7708 : True RMS

	Range	Accuracy	Resolution	Max. Input Current	Overload Current
$\overline{\sim}$ A	400.0A	±1.5%rdg±5dgt	0.1 A	2000A DC	
	2000 A		1 A		
\sim A	400.0 A	±1.5%rdg±5dgt (50/60Hz) ±3%rdg±5dgt (40~1kHz)	0.1A	2000A rms	3000A rms (1 minute)
	2000 A		1 A		
Hz	Range		Accuracy	Resolution	Input Sensitivity
	1.000Hz~4.999 Hz		±0.2%rdg ±2dgt	1 mHz	10A (Sine Wave)
	5.00Hz~49.99 Hz			10mHz	
	50.0Hz~499.9 Hz			100mHz	
	0.500kHz~4.999kHz			1 Hz	
	5.00kHz~49.99kHz			10 Hz	
50.0kHz~100.0kHz		100 Hz			

- * Crestfactor ; Less than 3. Less than 1.5 for 2000A. (SK-7708 only)
- * Hz ; Autoranging only.

1-1. Peak Current \approx 3000A on $\overline{\sim}$ A Function (SK-7708 only)

	Range	Accuracy	Resolution	Max. Input Current	Overload Current
\sim A	2000A	±5.0%±5dgt	1A	2000A	3000A rms(1minute)

- * Less than 50A, not specified. Several digits remain in PH Mode.

- 5 -

2. $\overline{\sim}$ / \sim · Hz · % (DC Voltage / AC Voltage · Hz · %)

SK-7707 : Average Rectification
SK-7708 : True RMS

	Range	Accuracy	Resolution	Input Resistance	Max. Input Voltage
$\overline{\sim}$ V	400.0 mV	±1.2%rdg±3dgt	0.1 mV	≥100M Ω	600V DC
	4.000 V		1 mV	≈11M Ω	
	40.00 V		10 mV	≈10M Ω	
	400.0 V		100 mV		
	600 V		1 V		
\sim V	4.000 V	±1.5%rdg±5dgt (40~400Hz) ±3%rdg±5dgt (401~1kHz)	1 mV	≈11M Ω	600V rms
	40.00 V		10 mV	≈10M Ω	
	400.0 V		100 mV		
	600 V		1 V		
Hz	Range		Accuracy	Resolution	Input Sensitivity
	1.000Hz~ 4.999Hz		±0.2%rdg ±2dgt	1mHz	5V (Sine Wave)
	5.00Hz~ 49.99Hz			10mHz	
	50.0Hz~ 499.9Hz			100mHz	
	0.500kHz~4.999kHz			1 Hz	
	5.00kHz~49.99kHz			10 Hz	
50.0kHz~100.0kHz		100 Hz		not specified	
%	0.1 % ~ 99.9%	±2%rdg±2dgt	0.1%	5A(Square Wave)	

- * Crestfactor : Less than 3. Less than 2 for 600V. (SK-7708 only)
- * Overload Protection : 1200V rms 1 minute. * Hz ; Auto Ranging only.
- * 4V Range not specified for 401Hz~1kHz.

3. Ω (Resistance)

Range	Accuracy	Resolution	Measurement Current	Open Circuit Voltage
400.0 Ω	±1.5%rdg±5dgt	0.1 Ω	≤0.4mA	≈0.44 V
4.000 k Ω		1 Ω		
40.00 k Ω	±1.0%rdg±3dgt	10 Ω	≤50 μ A	
400.0 k Ω		100 Ω	≤5 μ A	
4.000 M Ω	±3.0%rdg±4dgt	1 k Ω	≤0.5 μ A	
40.00 M Ω	±5.0%rdg±7dgt	10 k Ω	50nA	

- * Range Selection : Auto / Manual Ranging.
- * Overload Protection : 300V rms 1minute.

- 6 -

4. \rightarrow (Continuity Test)

Buzzer	Range	Accuracy	Resolution	Measurement Current	Open Circuit Voltage
<=50 Ω	400.0 Ω	±1.5%rdg±5dgt	0.1 Ω	≤0.4 mA	≈0.44 V

- * Overload Protection : 300V rms 1minute.

5. \rightarrow (Diode Test)

Range	Accuracy	Resolution	Open Circuit Voltage	Overload Voltage
0~1.5V	±5%rdg±5dgt	1mV	≤1.7V	300V rms(1minute)

6. \rightarrow (Capacitance)

Range	Accuracy	Resolution	Open Circuit Voltage	Overload Voltage
50.00 nF	±5%rdg±10dgt	10pF	≤1.7V	300V rms (1minute)
500.0 nF		100pF		
5.000 μ F		1nF		
50.00 μ F		10nF		
100.0 μ F		100nF		

- * \rightarrow : Autoranging only.

- 7 -

3. NAME ILLUSTRATION

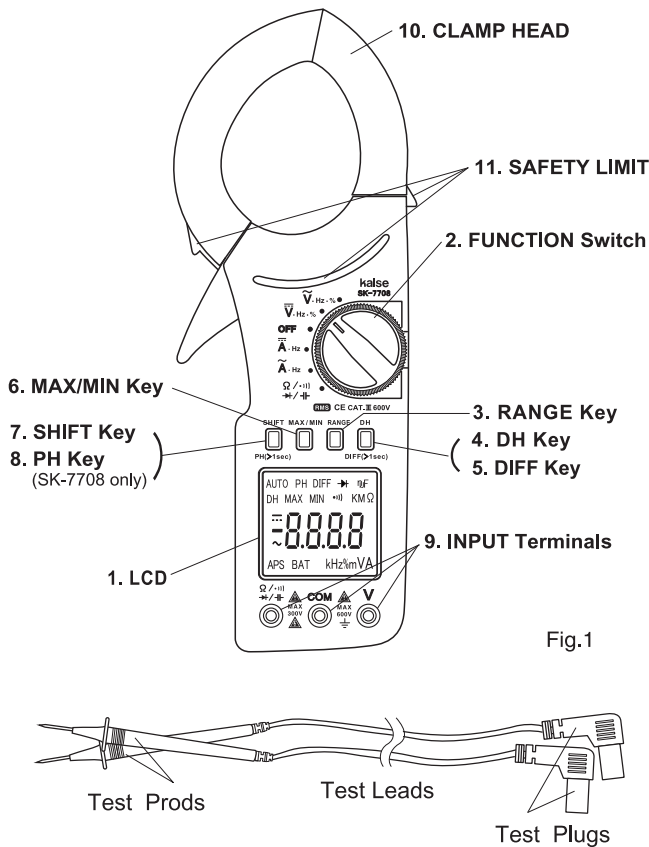

Fig.1

3. RANGE Key (Range Selection)

Press RANGE Key to select Autorange or Manual-ranging when measuring current, voltage or resistance. Manual-ranging is selected in two ways as follows.

1. When power is turned on rotating FUNCTION Switch from OFF position, the range is always selected in the first into Autorange with AUTO symbol turned on. Then, press RANGE Key several times watching the movement of the decimal points on LCD to select desired ranges.
2. When measuring values in Autorange, press RANGE Key. The range to which measuring value belong is held. To cancel Manual-ranging, press RANGE Key for more than 1 second. Autorange is selected with AUTO symbol turned on.

4. DH Key

Press this Key to hold display of LCD. All displays are held with DH symbol shown on LCD. To cancel DH Key, press it again and DH symbol turns off.

NOTE : Press this Key to read measurement value held after removing Clamp Head or Test Leads from testing circuit.

NOTE : When DH Key is operating with DH symbol shown on LCD, the other Keys can not operate.

5. DIFF Key (Difference Measurements)

DIFF Key provides Zero Adjustment as well as Difference Measurements.

1. ZERO-Adjustment

The instrument performs POWER-ON INITIALIZE automatically with FUNCTION Switch set to desired position.

If INITIALIZE is performed exactly, LCD will display 0 ± 1 digit. But, sometimes LCD displays 3-4 digits due to residual magnetism on the clamp head. In this case, click CLAMP HEAD slightly several times. If not yet effective, press DIFF Key more than 1 second with DIFF symbol turned on, and LCD will display 0 ± 1 digit with DIFF symbol shown.

1. LCD



≡	: Direct Current (DC)
~	: Alternative Current (AC)
-	: Minus symbol
AUTO	: Autoranging.
PH	: Peak Hold (SK-7708 only)
DIFF	: Difference Measurements
DH	: Display Hold
MAX	: Maximum Value Measurements
MIN	: Minimum Value Measurements
A	: Unit of Current
mV, V	: Unit of Voltage
Hz, kHz	: Unit of Frequency
%	: Unit of Duty Cycle
Ω , k Ω , M Ω	: Unit of Resistance
•••	: Continuity Buzzer
→	: Diode Tests
nF, μ F	: Unit of Capacitance
APS	: Auto Power Save
BAT	: Battery Warning

2. FUNCTION Switch

Power and Functions are selected easily with rotating the FUNCTION Switch. Set FUNCTION Switch to a desired position. Do NOT fail to set FUNCTION Switch to OFF position when measurements are finished. If POWER OFF is failed, power turns off automatically after 12 minutes.

NOTE : Generally, start measurements to see 0 ± 1 digit on LCD. But, the specified accuracy is ensured even if measurements are made with 3 to 4 digits remained.

2. Difference Measurements

When measuring a desired value or applying a desired value on the insurement, press DIFF Key more than 1 second to see DIFF symbol turned on, and the desired value(X_0) is stored and converted to display 0 ± 1 digit on LCD. The difference between measuring value(X_n) and the stored value(X_0) is displayed on LCD with succeeding measurements. Difference = $X_n - X_0$.

NOTE : + difference is displayed if a measurement value is larger than the stored value, and - difference when that is smaller. In case of + difference, + sign is implied.

NOTE : When Difference Measurements are made, Maximum Input Value should be the same as follows.

\tilde{A} or \bar{A}	: 2000A max.
\tilde{V} or \bar{V}	: 600V max. CAT III, 1000V max. CAT II.
Ω (Resistance)	: 40 M Ω

To cancel DIFF Key, press DIFF Key for more than 1 second and the symbol turns off.

NOTE : When DIFF Key is operating, DH Key or MAX/MIN Key can operate.

Measuring Example when measuring \tilde{A}

DIFF Key operates and Display changes as follows.

Press DIFF Key for more than 1 second in the 1st press. In the 2nd press and later, press DIFF Key for less than 0.5 second.

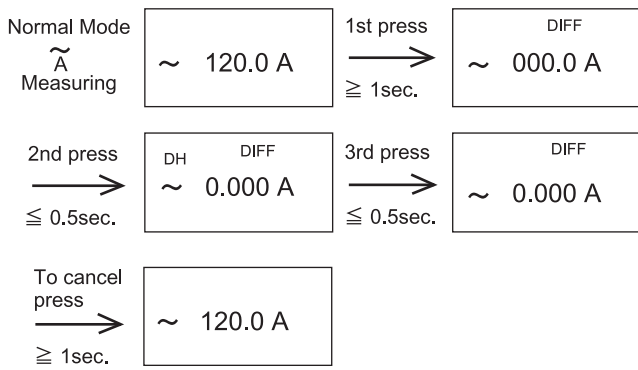

To cancel DIFF Mode, press DIFF Key for more than 1 second. DIFF symbol turns off.

6. MAX/MIN Key (Maximum / Minimum Measurements)
 Press this Key for less than 0.5 sec. to select MAX/MIN Mode. MAX/MIN values are recorded and displayed on LCD with each symbol turned on.

Measuring Example when measuring \bar{A}
 MAX/MIN Key operates and Display changes as follows.

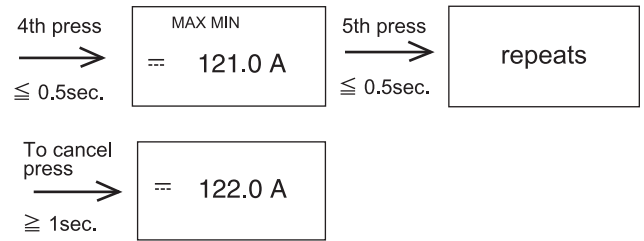
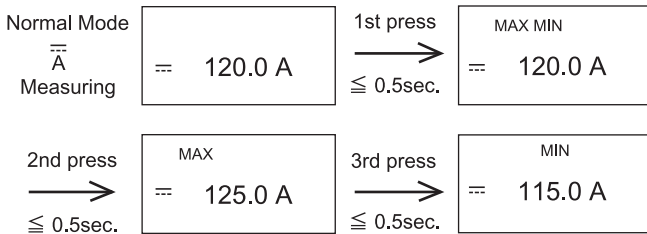

To cancel this Mode, press MAX/MIN Key for more than 1 second and the symbol turns off.

7. SHIFT Key (Hz / %, Ω / $\bullet\text{||}$ / $\rightarrow\text{+}$ / +)

1. SHIFT Key when measuring \tilde{A}

Each press of SHIFT Key changes the Display.

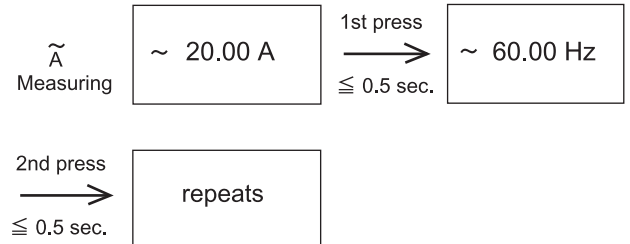

2. SHIFT Key when measuring \tilde{V}

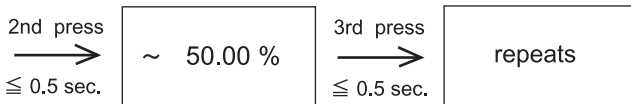
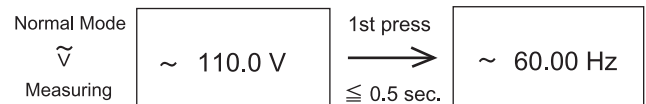

1) DUTY CYCLE (%)

Duty Cycle is shown in percent and means the time of input signal that is above the trigger level. Duty Cycle is used when measuring ON or OFF time of logic or switching controls.

Example : Fuel injection control of automobiles, Dwell angle (use the following formula), air conditioning control or inverter control of motor.

$$\text{Dwell (angle)} = \frac{\text{Duty Cycle (\%)} \times 360 \text{ degrees}}{\text{No. of Cylinders} \times 100}$$

NOTE : Above measurement is available when the Minimum Pulse Width is greater than 1mS and Frequency is between 10Hz and 200Hz.

3. SHIFT Key when measuring Ω

$\Omega \rightarrow \bullet\text{||} \rightarrow \rightarrow\text{+} \rightarrow \text{nF}(\text{+}) \rightarrow \Omega$

8. PH Key on \bar{A} (Peak Value Measurements of \bar{A} or \tilde{A} : SK-7708 only)

When measuring \bar{A} , press PH Key for more than 1 sec to select PH Mode. PH symbol is turned on and peak value is recorded at 10m sec and displayed. Peak is measured with \bar{A} or \tilde{A} only, and not available with the other functions.

Measuring Example :

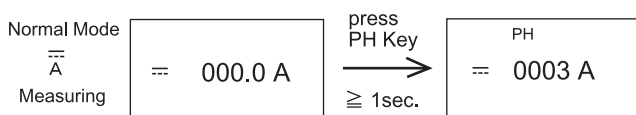

* Several digits remain.

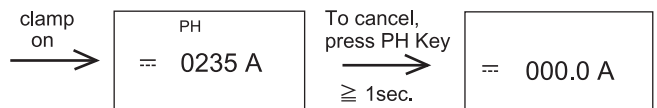

To cancel PH Mode, press PH Key for more than 1 second. PH symbol turns off.

9. INPUT Terminals

To measure voltage, insert Plugs of Test Leads into COM and V Terminals. To measure Resistance (Ω), Continuity ($\bullet\text{||}$), Diode ($\rightarrow\text{+}$), and Capacitance (+), insert Plugs of Test Leads to COM and $\Omega / \bullet\text{||} / \rightarrow\text{+} / \text{+}$ Terminals.

⚠ WARNING : INPUT Terminals are not used to measure Current (A). For safety, remove Test Leads from INPUT Terminals when measuring Current.

⚠ WARNING : Risk of Electric Shock exists on the Terminal marked with Δ when voltage is being measured on COM and V Terminals.

10. CLAMP HEAD

When measuring Current DC or AC, just clamp on a single conductor to be tested in the center of CLAMP HEAD.

In case of DC, make sure that the polarity of the conductor to be measured complies with \downarrow mark (plus to minus) on Clamp Head. The accuracy is ensured regardless of the conductor position in Clamp Head.

11. SAFETY LIMIT Indicator

For safety, Finger-tips should be placed on the instrument not to exceed the indicator.

4. SAFETY PRECAUTIONS

Correct understanding about electric measurements is necessary because electric measurement is sometimes a very dangerous work. To eliminate possibility of injury to the operator and damage to the instrument, the following precautions and measurement procedures must be taken. Misuse, abuse and carelessness cannot be prevented by any written word and is fully the operator's responsibility. Observing the following precautions, take safe measurements.

4-1. WARNINGS FOR MEASUREMENTS

⚠ WARNING 1. Checks of Body

Before every measurement, do not fail to confirm that Body of this instrument and handle insulators of the attached Test Leads have no cracks nor any other damage on them. Make sure that the body and the handle insulators are free of dust, grease and moisture.

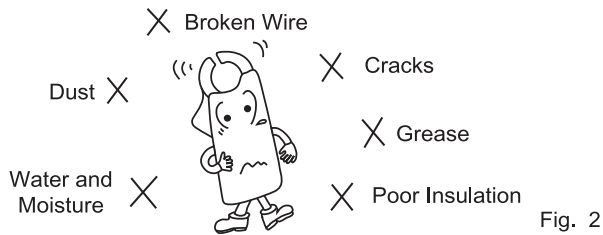

⚠ WARNING 2. Warning for High Power Line Measurements

High Power Lines (High Energy Circuits) such as Distribution Transformers, Bus Bars, Large Motors, etc. are very dangerous. High Power Line sometimes includes High Surge Voltage that could induce explosive short in the instrument and could result in shock hazard. When measuring dangerous voltage of High Power Line, do not touch the Clamp Meter, its Test Leads or any part of the Circuit while it is on.

— 16 —

⚠ WARNING 3. Warning for High Voltage Measurements

Even if with Low Energy Circuits of electric/electronic appliances, heating elements, small motors, line cords, plugs, etc., High Voltage Measurements more than 240V are very dangerous. Do not touch the Clamp Meter and any part of the Circuit while it is on. Generally, shock hazard could occur when the current between the circuit, that involves more than 33V rms or 46.7V DC or peak, and ground goes up to 0.5mA or more.

⚠ WARNING 4. Dangerous Voltage Measurements

Always observe strictly the following measurement procedure when measuring dangerous voltage.

1. Before measurement, turn off power to the circuit to be measured.
2. Insert Black Test Plug of Test Leads into COM Terminal and Red Test Plug of Test Leads into V Terminal.
3. Attach Black and Red Alligator Clips (optional) to both Test Prods of Test Leads.
4. Set FUNCTION Switch to \tilde{V} or \bar{V} position.
5. Confirm that the power of the circuit to be measured is OFF. Then, connect Black Alligator Clip to $-$ (earth) side and Red Alligator Clip to $+$ (positive) side of the circuit to be measured.
6. Place the instrument away from your body, and do not touch it with your hands. Also, take safety distance from the power source or the circuit to prevent any part of your body from touching dangerous voltage.
7. Turn on power to the circuit to be measured and read the voltage on LCD.
8. When the measurement is finished, turn off power to the circuit to be measured and discharge all capacitors in the circuit.
9. Disconnect Alligator Clips of Test Prods from the circuit.

— 17 —

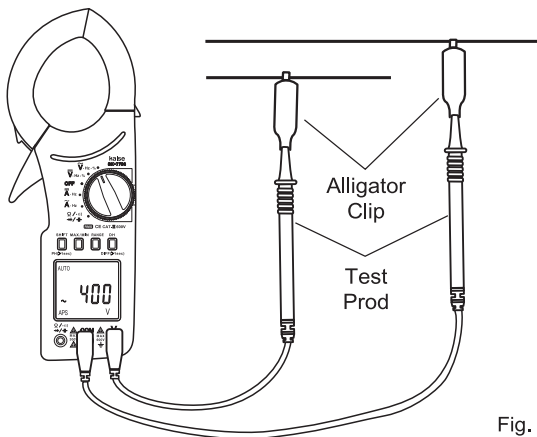

In case you want to measure live line, observe following procedure.

1. Place the instrument away from your body.
2. Set FUNCTION Switch to $\sim V$ position.
3. Take safety distance from the power or the circuit to be measured to prevent any part of your body from touching dangerous voltage.
4. Attach Black Alligator Clip to Black Test Prod. Then, connect Black Alligator Clip to $-$ (earth) side of the circuit to be measured.
5. Hold Red Test Prod with one hand and connect it to $+$ (positive) side of the circuit to be measured.
6. Read the voltage on LCD. Refer to the Fig 4.
7. When the measurement is finished, disconnect Red Test Prod from the circuit and then disconnect Black Alligator Clip from the circuit.

— 18 —

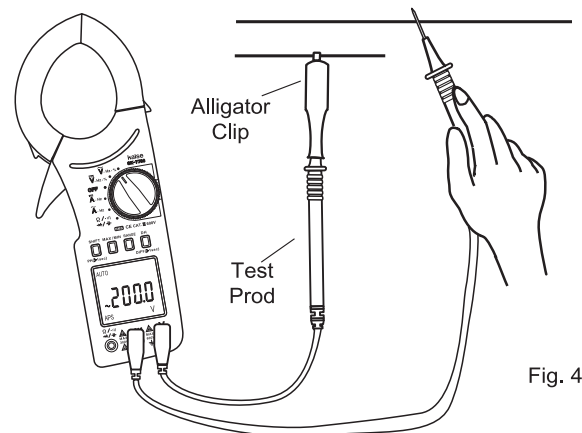

⚠ WARNING 5. Correct Selection of FUNCTION Switch

When taking measurements, always confirm that FUNCTION Switch is set to correct position. Do not measure voltage on Ω / \rightarrow position.

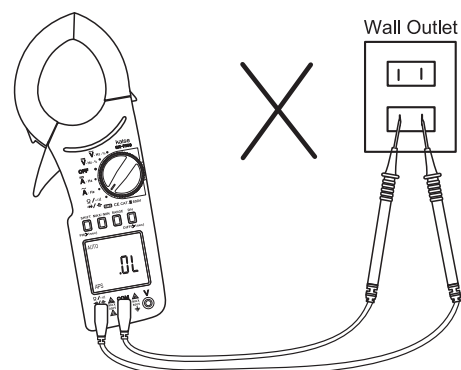

— 19 —

⚠ WARNING 6. Maximum Input Observance

Do not attempt to measure voltage or current that might exceed the specified maximum input of the function being used.

⚠ WARNING 7. Test Leads Disconnection

Prior to changing FUNCTION Switch to another position when measuring, or removing Rear Case for replacement of battery, always disconnect Test Leads from the circuit being measured.

⚠ WARNING 8. SAFETY LIMIT INDICATOR

Do not let the fingers exceed the Limit Indicator when measuring current.

**SAFETY
LIMIT INDICATOR**



Fig. 6

4-2. CAUTIONS IN HANDLING

⚠ WARNING 1. Do not let the children use the instrument or those people who have no knowledge and experience of electric measurements.

⚠ WARNING 2. It is very dangerous and lethal to measure High Power Line. Do not take measurements in a naked or barefooted state.

⚠ WARNING 3. The points of Test Prods are sharp and dangerous. Do not get hurt with them.

⚠ CAUTION 1. Do not attempt to clean the Body of Clamp Meter with any cleaning fluid like gasoline, benzene, alcohol, etc. To clean the body use silicon oil or antistatic fluid.

⚠ CAUTION 2. Avoid severe mechanical shock or vibration, extreme temperature or very strong magnetic fields.

⚠ CAUTION 3. Remove the battery when not in use for an extended time since the exhausted battery might leak electrolyte and corrode the internal components.

5. MEASUREMENT PROCEDURES

5-1. PREPARATION FOR USE

1. INSTRUCTION MANUAL

Prior to use, read INSTRUCTION MANUAL carefully and acquaint yourself with the specifications and functions of the instrument. Especially, read and observe strictly the 「4. SAFETY PRECAUTIONS」.

2. BATTERY

One 9V 6F22 battery is furnished with this instrument. Remove Battery Cover by unscrewing the screw on it. Place the battery taking care of polarity and contact. Replace Battery Cover and screw. When the battery is consumed and BAT symbol is shown on LCD, open Battery Cover and replace the battery. Refer to 「6-2. BATTERY REPLACEMENT」 on page 33~34.

3. TEST LEADS

Always use Test Leads that complies with IEC Specification (IEC 61010-031 and 600V ~) for safety.

Insert Black Test Plug of Test Leads into COM Terminal and Red Test Plug of Test Leads into V or Ω / \bullet / \rightarrow / \leftarrow Terminal. Test Prods of Test Leads are connected to the circuit to be measured. It is good practice to use Black Test Lead for COM Terminal (- polarity) and Red Test Lead for V or Ω / \bullet / \rightarrow / \leftarrow Terminal (+ Polarity).

4. FUNCTION Switch

Set FUNCTION Switch to desired position and make certain that all display segments appear for 1 second.

NOTE: If the display does not appear or BAT symbol appears when FUNCTION Switch is set to desired position, the battery must be consumed.

NOTE: Make certain that DH Key is not pressed ON. If DH Key is operative, measurements can not be performed.

5. AUTO POWER SAVE

After about 12 minutes of last operation of FUNCTION Switch, or the other Keys, power turns off automatically (goes down in sleep condition and 0.01mW consumption) with LCD displayed off. This function prevents battery consumption when power off is failed.

NOTE : To cancel AUTO POWER SAVE to make continuous measurements longer than 10 minutes, set FUNCTION Switch to desired position with pressing SHIFT Key on. APS symbol does not turn on.

NOTE : Also AUTO POWER SAVE does not work when MAX/ MIN Key is on. Therefore, continuous measurements longer than 10 minutes can be made with MAX/MIN Key pressed.

6. OVERLOAD (OVERRANGE) INDICATION

When measuring Current or Voltage, OL symbol does not turn on even if input value exceeds the Maximum Input Value, \equiv / \sim 2000A or \equiv / \sim 600V

⚠ WARNING

Do not attempt to make any measurements that might exceed the maximum value of the function being used to avoid electrical shock hazard and/or damage to the instrument.

7. SYMBOL MARK

The following symbols shown on the instrument and in the instruction manual are listed in IEC 61010-1 and ISO 3864.

- : Warning or Caution (refer to instruction manual.)
- : Warning, Risk of electric shock
- \equiv : Direct Current (DC)
- \sim : Alternating Current (AC)

- \sim : DC and AC
- \perp : Earth (Ground)
- : Double Insulation

8. POWER-ON INITIALIZE

The instrument performs POWER-ON INITIALIZE automatically when turning on the power.

This function is effective when turning on the power without any inputs. If any inputs are applied to the instruments, it does not work correctly. LCD will display 0±1 digit when INITIALIZE was done correctly. If LCD does not display it, turn the power on again or press DIFF Key.

NOTE: INITIALIZE sometimes does not work correctly due to some CPU error even if no inputs are applied. If LCD displays 3 digits or more, use DIFF Key.

NOTE: For current measurements near the high current conductor, INITIALIZE does not work correctly. In this case, take the instruments away from the conductor, and turn the power on again.

5-2. $\overline{\sim}$ · Hz / $\overline{\sim}$ · Hz (\approx 2000A) MEASUREMENTS

⚠ WARNING

Maximum Input Current of Current function is 2000A \equiv / \sim (Line Voltage 600V \equiv / \sim max.) Do not attempt to measure current that might exceed the maximum input values of the functions being used. Prior to measurements, read carefully 「4. SAFETY PRECAUTIONS」 of this instruction manual to avoid electrical shock hazard and/or damage to the instrument.

1. Set FUNCTION Switch to $\overline{\sim}$ · Hz or $\overline{\sim}$ · Hz position.

⚠ WARNING

Test Leads are not required when measuring Current only. For safety measurements, remove Test Leads from INPUT Terminals. Do not touch any part of the Power Line or the Circuit while it is on.

- Open CLAMP HEAD and clamp on a single conductor.
NOTE: If two or three conductors are clamped on at a time, the measurement cannot be made.
NOTE: In case of measuring DC current, clamp on the conductor with Front Case faced to + polarity.
- Read the current on LCD.
- SHIFT Key** : Press SHIFT Key to measure Hz.
- RANGE Key** : Press RANGE Key to select Autorange or Manual-range. Refer to page 10.
- DIFF Key** : Press DIFF Key for more than 1 second to make Difference measurements. Refer to page 10 to 12.
- MAX/MIN Key** : Press this Key to make MAX/MIN measurements. Refer to page 12 to 13.
- PH Key (SK-7708 only)** : On $\overline{\sim}$ A Function, press PH Key for more than 1 second to make Peak Hold measurements. Disregard several amperes that remain in PH Mode. Refer to page 14 to 15.
- DH Key** : Press this Key to hold display. Refer to page 10.
- When measurements are finished, remove CLAMP HEAD from the conductor being measured and set FUNCTION Switch to OFF position.

Measurement Example 1. Battery Test when starting the engine of Automobile. Maximum Current of the battery can be measured.

- Set FUNCTION Switch to $\overline{\sim}$ Hz position.
- Open Clamp Head and clamp on the (-) cable of the battery to be measured with the Clamp Meter faced to (+) polarity.
NOTE: Make sure of the polarity and clamp on the conductor according to the ↓ (plus to minus) mark on Clamp Head.
- Press MAX/MIN Key once to display MAXMIN symbols on LCD. (refer to page 12 to 13, MAX/MIN Key)
- Press MAX/MIN Key to display MAX symbol.
- Start the engine of automobile.
- Read MAX Current on LCD.

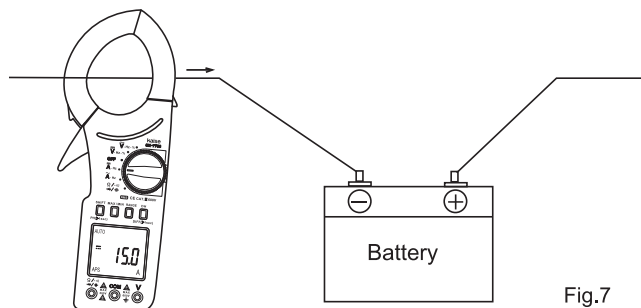

Fig.7

Measurement Example 2.
Measuring AC Current

- Set FUNCTION Switch to $\tilde{\sim}$ Hz position.
- Open CLAMP HEAD and clamp on the conductor.
- Read the current on LCD.
- SHIFT Key** : When measuring AC Current, press SHIFT Key to measure Hz.
- When measurements are finished, remove Clamp Head from the conductor being measured and set FUNCTION Switch to OFF Position.

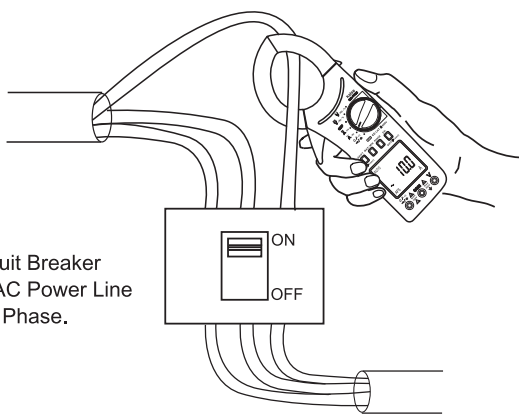

Fig.8

5-3. $\overline{\sim}$ Hz · % / $\tilde{\sim}$ Hz · % (\approx 600V) MEASUREMENTS

⚠ WARNING

Maximum Input Voltage of Voltage function is 600V for CAT III, and 1000V for CAT II. Do not attempt to measure voltage that might exceed the Maximum Input Voltage of the function being used. Prior to measurements, read carefully 「4. SAFETY PRECAUTIONS」 of this instruction manual to avoid electrical shock hazard and/or damage to the instrument.

- Insert Black Test Plug into COM Terminal and Red Test Plug into V Terminal.
- Set FUNCTION Switch to $\tilde{\sim}$ Hz · % or $\overline{\sim}$ Hz · %
- Connect Test Prods of Test Leads to the circuit to be measured.
NOTE: When taking voltage measurements, always connect the instrument IN PARALLEL with the circuit being measured.

- Read voltage on LCD.
- Press SHIFT Key to measure Hz and %.
- RANGE, MAX/MIN, DIFF and DH Keys are available. Refer to page 10 to 13.
- When measurements are finished, remove Test Prods from the circuit and set FUNCTION Switch to OFF position.

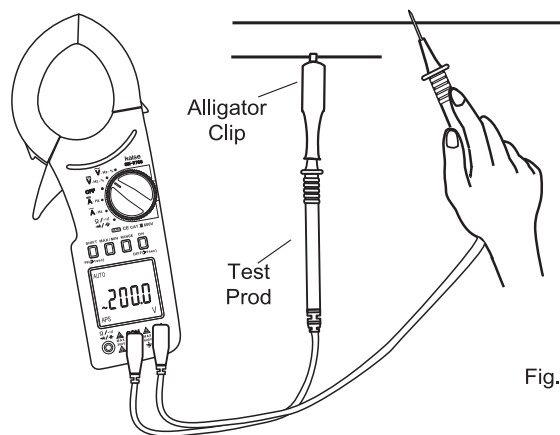

Fig.9

5-4. Ω (RESISTANCE 40M Ω) MEASUREMENTS

⚠ WARNING

Do not measure Voltage on Ω position. This will cause shock hazard to the operator and damage to the instrument. In case in-circuit resistance is measured, turn off power to the circuit being measured and discharge all capacitors in the circuit. Prior to measurements, read carefully 「4. SAFETY PRECAUTIONS」 of this instruction manual.

1. Insert Black Test Plug into COM Terminal and Red Test Plug into $\Omega / \bullet \text{||}$, $\rightarrow \text{||}$ / || Terminal.
2. Set FUNCTION Switch to $\Omega / \bullet \text{||}$, $\rightarrow \text{||}$ / || position. O.L M Ω is shown on LCD.
3. Short Test Prods of Test Leads together. The instrument sometimes displays 2 to 3 digit on LCD due to small resistance of Test Leads. In this case, press DIFF Key to display 0 on LCD for more accurate measurement.
4. If the resistor to be measured is connected in a circuit, turn off power to the circuit and discharge all capacitors in the circuit.
5. Open one side of the resistor to be measured and connect Test Prods to both sides of the resistor (or circuit).
6. Read the resistance on LCD. Refer to the Fig. 10.
7. RANGE, MAX/MIN, DIFF and DH Keys are available. Refer to page 10 to 13.
8. When measurements are finished, remove Test Prods from the resistor (circuit) and set FUNCTION Switch to OFF position.
9. Then restore the circuit as it was.

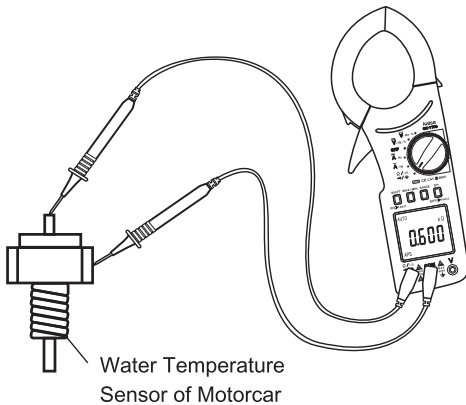

Fig. 10

5-5. $\bullet \text{||}$ (CONTINUITY) TESTS

⚠ WARNING

Do not measure Voltage on $\bullet \text{||}$ position. This will cause shock hazard to the operator and damage to the instrument. In case circuit continuity is tested, turn off power to the circuit being measured and discharge all capacitors in the circuit. Prior to measurements, read carefully 「4. SAFETY PRECAUTIONS」 of this instruction manual.

1. Insert Black Test Plug into COM Terminal and Red Test Plug into $\Omega / \bullet \text{||}$, $\rightarrow \text{||}$ / || Terminal.
2. Set FUNCTION Switch to $\Omega / \bullet \text{||}$, $\rightarrow \text{||}$ / || position.
3. Press SHIFT Key 1 time to display OL. $\bullet \text{||}$ Ω on LCD.
4. Turn off power to the circuit to be tested and discharge all capacitors in the circuit.
5. Connect Test Prods of Test Leads to the circuit to be tested.
6. Buzzer sounds when the resistance value is less than approx. 50 Ω .
7. When tests are finished, remove Test Prods from the circuit and set FUNCTION Switch to OFF position.

5-6. $\rightarrow \text{||}$ (DIODE) TESTS

⚠ WARNING

Do not measure Voltage on $\rightarrow \text{||}$ position. This will cause shock hazard to the operator and damage to the instrument. In case in-circuit diode is tested, turn off power to the circuit being measured and discharge all capacitors in the circuit. Prior to measurements, read carefully 「4. SAFETY PRECAUTIONS」 of this instruction manual.

1. Insert Black Test Plug into COM Terminal and Red Test Plug into $\Omega / \bullet \text{||}$, $\rightarrow \text{||}$ / || Terminal.
2. Set FUNCTION Switch to $\Omega / \bullet \text{||}$, $\rightarrow \text{||}$ / || position.
3. Press SHIFT Key 2 times to display .OL $\rightarrow \text{||}$ V on LCD.
4. Turn off power to the circuit and discharge all capacitors in the circuit. Open one side of the diode from the circuit.
5. Connect Test Prods of Test Leads to the diode to be tested.
6. In case of diode, connect Black Test Prod to Cathode and Red Test Prod to Anode of the diode to be measured.
In case of transistor, connect Test Prods to Emitter Pin and Base Pin depending on PNP or NPN type transistor to be measured. Refer to the following figures.
In case of an ordinary diode, the display shows 0.5V to 0.8V. If the diode is defective and in short condition, the display shows nearly 0V, and if the diode is in open condition, the display shows OL symbol.
NOTE : In case of germanium diode (except point contact type diode), Forward Voltage is approx. 0.2V to 0.4V. Point Contact Type Diode shows different value from its electrical characteristic.
7. Reverse Test Prod connection to the device being measured. If the diode is good, the display shows OL symbol, the same value in open condition, and if the diode is defective and in short condition, the display shows nearly 0V.
8. When tests are finished, remove Test Prods from the device and set FUNCTION Switch to OFF position.

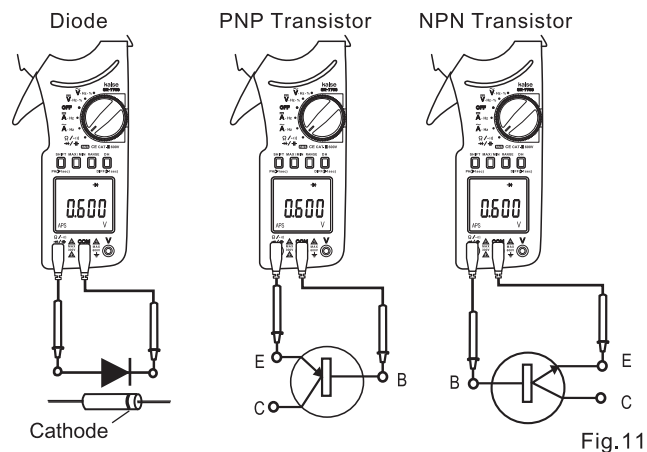

Fig.11

5-7. || (CAPACITANCE) MEASUREMENTS

⚠ WARNING

Do not measure Voltage on || position. This will cause shock hazard to the operator and damage to the instrument. In case in-circuit capacitor is measured, turn off power to the circuit being measured and discharge all the capacitors in the circuit. Prior to measurements, read carefully 「4.SAFETY PRECAUTIONS」 of this instruction manual.

1. Insert Black Test Plug into COM Terminal and Red Test Plug into $\Omega / \cdot 100$, $\rightarrow \nabla / \nabla \leftarrow$ Terminal.
2. Set Function Switch to $\Omega / \cdot 100$, $\rightarrow \nabla / \nabla \leftarrow$ position.
3. Press SHIFT Key 3 times to display X nF on LCD.
4. Press DIFF Key (≥ 1 sec.) to display less than 0 ± 3 digit on LCD.
5. Turn off power to the capacitor and discharge all capacitors in the circuit. Open one side of the capacitor to be tested.
6. Connect Test Prods of Test Leads to the capacitor to be tested.
7. Read the capacitance on LCD.
8. DH Key is available.
9. When measurements are finished, remove Test Prods from the capacitor and set FUNCTION Switch to OFF position.

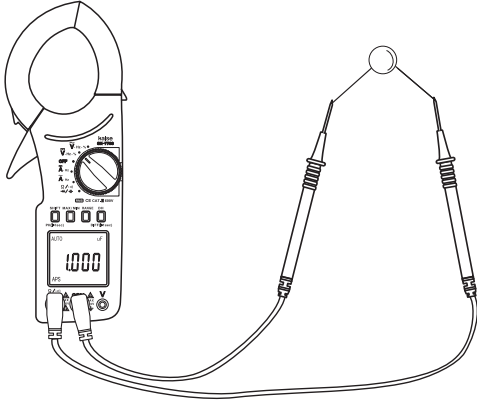

Fig.12

6. MAINTENANCE

6-1. WARRANTY STATEMENT

The warranty statement for the Clamp Meter is printed on the last page of the manual. Read it carefully before requesting a warranty repair.

6-2. BATTERY REPLACEMENT

WARNING

To prevent electrical shock hazard, remove both Test Leads from external circuit connections and from the Input Terminals before removing Battery Cover to replace the battery.

1. If the battery is consumed and BAT symbol is shown on LCD, replace the battery.
2. Remove both Test Leads from the circuit and from the Terminals.
3. Set FUNCTION Switch to OFF position.
4. Remove Battery Cover unscrewing the 1 screw.
5. Take out the worn-out battery from Battery Case.
6. Place one fresh 9V 6F22 in Battery Case.

NOTE : If the battery is installed in the wrong polarity, the display will not be shown when FUNCTION Switch is turned on. Do not leave the instrument in this condition as it results in battery consumption.

7. Replace Battery Cover and screw.

NOTE : If the instrument is taken out of service for an extended time, remove the battery from Battery Case and store separately.

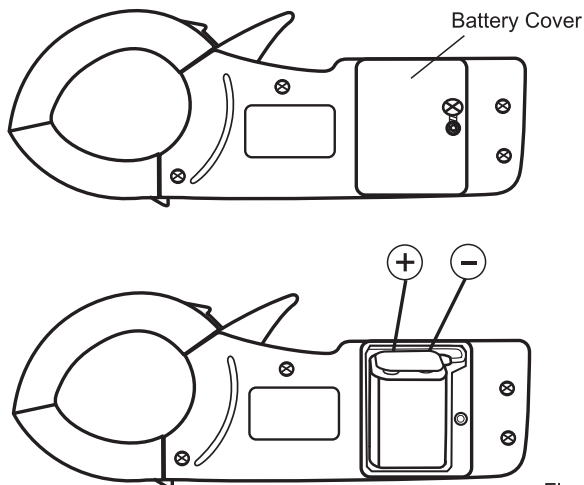

Fig.13

6-3. PERIODICAL CHECK AND CALIBRATION

Periodical check and calibration are necessary to make safety measurements as well as to maintain the specifications described on page 3 to 7.

It is recommended that the instrument may be checked and calibrated once each year and/or after it is repaired. Periodical Check and Calibration services are available at KAISE AUTHORIZED SERVICE AGENCY through your local dealer at a cost basis charge.

Pack the instrument securely in its original carton together with descriptions of your name, address, telephone number, problem encountered and the service required, and ship prepaid to your local dealer.

6-4. REPAIR

Repair service, warranty or non-warranty, is available at KAISE AUTHORIZED SERVICE AGENCY through your local dealer. Warranty repair is executed free of charge, but, non-warranty repair is charged on the cost basis.

Pack the instrument securely in its original carton together with descriptions of your name, address, telephone number, problem encountered and the service required, and ship prepaid to our local dealer.

When the instrument does not operate properly, the following steps should be taken before returning the instrument for repair, warranty or non-warranty.

SYMPTOM	POSSIBLE CAUSE	NECESSARY STEPS
No Display.	Low Battery.	Replace the battery. (Refer to P33~34.)
	Battery is installed in the wrong polarity.	Install battery in the correct polarity.
Readings are not stable on all functions.	The contact of Plugs of Test Leads is bad.	Confirm the contact of Plugs.
	Influence of noise.	Use a suitable shield or keep away from noise.
FUNCTION Switch is set to desired position and LCD displays some value under no input being applied.		<p>If LCD displays 1 to 3 digits, continue the measurement.</p> <p>If LCD displays more than several digits and INITIALIZE is not performed exactly, press DIFF Key to display zero on LCD and perform measurements.</p> <p>In this case, accurates measurements are ensured.</p>

WARRANTY

The Clamp Meter, SK-7707/7708 is warranted in its entirety against any defects of material or workmanship under normal use and service within a period of one year after the date of purchase of the instrument by the original purchaser. This warranty is extended by **KAISE AUTHORIZED DEALER** only to original purchaser or original user of the instrument on condition that the Warranty Registration Card is completed and returned to the authorized dealer within two weeks after the purchase of the instrument new from the dealer. The obligation under this warranty to be executed by **KAISE AUTHORIZED DEALER** is limited to repairing or replacing the Clamp Meter SK-7707/7708 returned intact to it, with transportation charge prepaid, and which to its satisfaction is judged by it to have been thus defective. **KAISE AUTHORIZED DEALER** and **KAISE CORPORATION**, the manufacturer shall not otherwise be liable for any damages or loss, consequential or otherwise. The foregoing warranty is exclusive and in lieu of all other warranties including any warranty of merchantability, whether expressed or implied. This warranty shall not apply to any instrument or other article of equipment which shall have been repaired or altered outside **KAISE AUTHORIZED SERVICE AGENCY**, nor which has been subject to misuse, negligence or accident, incorrect repair by users, or installation or use not in accord with instructions furnished by the manufacturer.

KAISE AUTHORIZED DEALER

KAISE CORPORATION

422 Hayashinogo, Ueda City,
Nagano Pref., 386-0156 Japan

TELEPHONE : +81-268-35-1600(REP.)

FAX : +81-268-35-1603

E-mail : sales@kaise.com

http://www.kaise.com

Product specifications and appearance are subject to change without notice due to continual improvements.

kaise



INSTRUCTION MANUAL

AC / DC DIGITAL CLAMP METER

MODEL	SK-7707 SK-7708
--------------	----------------------------------

KAISE CORPORATION