

# IGNITION ANALYZER

Instruction Manual

**KG-300**



**KAISE CORPORATION**

Thank you for purchasing "KG-300 IGNITION ANALYZER".

To obtain the maximum performance of this instrument, read this Instruction Manual carefully, and take safe measurement.

## **CONTENTS**

<b>SAFETY PRECAUTIONS</b> .....	1~5
<b>OPERATING PRECAUTIONS</b> .....	6
<b>UNPACKING AND INSPECTION</b> .....	7
<b>NAME ILLUSTRATION</b> .....	8~10
<b>SPECIFICATIONS</b>	
1. General Specifications .....	11
2. Measurement Specifications .....	11
<b>MEASUREMENT PROCEDURES</b>	
1. Flexible Probe and Sensor Setup .....	12
2. Engine Cycle Setting .....	13
3. Start Measurement .....	14
4. Measurement Mode Setting .....	15
5. Display Mode Setting .....	16~20
<b>MEASUREMENT EXAMPLES</b>	
1. Normal Ignition Coil Waveform .....	21
2. Failure Ignition Coil Waveform .....	21~23
<b>MAINTENANCE</b>	
1. Recharging the Instrument .....	24~25
<b>TROUBLE SHOOTING</b> .....	26
<b>ABOUT KAISE WEBSITE</b> .....	27
<b>WARRANTY</b> .....	28

## **SAFETY PRECAUTIONS** (strict observance is required)

This instruction manual contains the important contents to prevent harm to user or others and damage of property, and to use the instrument safely and correctly.

Read this manual carefully and obey the contents after having understand the following terms and symbols.

- Following symbols in this manual describe the harm and damage that would be caused by incorrect usage.



### **WARNING**

This symbol in this manual advises the user of an electrical shock hazard that could result in serious injury or even death.



### **CAUTION**

This symbol in this manual advises the user of an electrical shock hazard that could cause injury or material damages.

- Caution marks that require your attention. (equivalent marks have the same meanings.)



Warnings and cautions that require your attentions.



Prohibited matters to protect the user and the product.



Mandatory matters that we ask to comply with.

## **SAFETY PRECAUTIONS** (strict observance is required)

### **WARNING**

**Put the vehicle in Parking gear (in Neutral gear for stick-shift vehicle).**

Car may run accidentally and could cause unexpected accident, electric shock, fire or damage to the instrument or to the vehicle.



**Apply parking brake.**

Car may run accidentally and could cause unexpected accident, electric shock, fire or damage to the instrument or to the vehicle.



**Keep the instrument away from babies or children.**

To prevent unexpected accident, injury, or electric shock hazard.



**Store the instrument in the supplied carrying case.**

To prevent unexpected accident, injury, or electric shock hazard.



**Stop using the instrument and keep away from fire when there are electrolyte leakage or unusual smell.**

Heat, burst, fire of the instrument, or injury, electric shock may occur.



**Do not touch leaking electrolyte. If attached to the skin or get into eyes, rinse immediately without rubbing, and consult a doctor.**

Damage to eyes and skin may occur.



**Insert USB connector all the way inside the socket.**

Dust around the socket may cause fire or electric shock.



**When charging the instrument, use the specified AC adapter and observe the specified charging rules.**

Heat, burst, fire of the instrument, or injury, electric shock may occur.



**Detach AC adapter after the instrument charged.**

Heat, burst, fire of the instrument, or injury, electric shock may occur.



**Charge the instrument under the temperature of 0 to 40°C.**

Heat, burst, fire of the instrument, or injury, electric shock may occur.



**Detach USB cable after completed the recharging.**

Heat, burst, fire of the instrument, or injury, electric shock may occur.



## SAFETY PRECAUTIONS (strict observance is required)

### **WARNING**

**Stop using the instrument immediately when feeling any abnormality.**

Heat, burst, fire of the instrument, or injury, electric shock may occur.



**Use fire extinguisher when the instrument ignited.**

Electric shock may occur if pouring the water.



**Wear insulated gloves when taking measurement.**

Accident, injury, or electric shock may occur.



**Do not use near the inflammable materials such as gasoline or oil.**

Fire or explosion may occur.



**Do not use the instrument with wet hands.**

Accident, electric shock, fire, or damage to the instrument or the vehicle may occur.



**Do not put flammable or heavy object on the instrument.**

**Do not wrap with thick cloth.**

Heat, fire, burst, or electrolyte leakage may occur.



**Do not use in the dark place.**

Accident, electric shock, fire, or damage to instrument / vehicle may occur.



**Do not get the instrument wet.**

Heat, burst, fire of the instrument, or injury, electric shock may occur.



**Do not use the instrument or its accessories in case of any damage.**

If you find any damage, immediately stop using the instrument and consult with your local dealer. Using the faulty instrument may cause the unexpected accident, fire, or electric shock.



**Do not touch the terminal or not insert foreign object.**

Heat, burst, fire of the instrument, or injury, electric shock may occur.



**Do not touch sensor and flexible probe when taking measurement.**

Injury, or electric shock may occur.



**Do not measure the damaged / electric leaked ignition system.**

Heat, burst, fire of the instrument, or injury, electric shock may occur.



## SAFETY PRECAUTIONS (strict observance is required)

### **WARNING**

**Store the instrument in the place less than 45°C and 70% humidity.**

**Avoid direct-sunlight and/or inside the sun-heated vehicle.**

Heat, burst, fire of the instrument, or injury, electric shock may occur.



**Do not attempt to disassemble or modify the instrument.**

Heat, burst, fire of the instrument, or injury, electric shock may occur.



**Do not use the cables with its insulation coating damaged.**

Heat, burst, fire of the instrument, or injury, electric shock may occur.



**Do not put the instrument into fire or water. Do not attempt to heat.**

Heat, burst, fire of the instrument, or injury, electric shock may occur.



**Do not put the instrument close to the hot apparatus.**

Heat, burst, fire of the instrument, or injury, electric shock may occur.



**Do not bind the cables when using.**

Heat, burst, fire of the instrument, or injury, electric shock may occur.



**Do not take long-time continuous measurement.**

Heat, burst, fire of the instrument, or injury, electric shock may occur.



**Do not leave the instrument in the engine compartment.**

Heat, burst, fire of the instrument, or injury, electric shock may occur.



**Do not use any cables except for the supplied ones.**

Heat, burst, fire of the instrument, or injury, electric shock may occur.



**Do not use the accessories with other instruments/equipments.**

Heat, burst, fire of the instrument, or injury, electric shock may occur.



**Do not drop or shock the instrument and the accessories.**

Heat, burst, fire of the instrument, or injury, electric shock may occur.



**Keep away from fire when using / recharging the instrument.**

Heat, burst, fire of the instrument, or injury, electric shock may occur.



**Keep away flammable objects when using / recharging the instrument.**

Heat, burst, fire of the instrument, or injury, electric shock may occur.



## SAFETY PRECAUTIONS (strict observance is required)

### **WARNING**

**Do not use the instrument around the flammable gas or liquid.**

Heat, burst, fire of the instrument, or injury, electric shock may occur.



**Do not put the instrument in microwave or high-pressure container.**

Heat, burst, fire of the instrument, or injury, electric shock may occur.



**Keep away the pet animals from the instrument.**

Heat, burst, fire of the instrument, or injury, electric shock may occur.



**Do not charge the instrument when it is full-charged.**

Heat, burst, fire of the instrument, or injury, electric shock may occur.



**Do not charge the instrument outside.**

Electric shock, fire, or injury may occur.



**Do not use the instrument with it charging.**

Heat, burst, fire of the instrument, or injury, electric shock may occur.



**Be sure to observe the usage written in the instruction manual.**

Heat, burst, fire of the instrument, or injury, electric shock may occur.



**Be careful about the instrument and probes not to be caught in the engine belt or cooling fan.**

Damage to the instrument and vehicle, or injury may occur.



**Be careful about your hands, gloves and clothes not to be caught in the engine belt or cooling fan.**

Injury may occur.



**Be careful about the instrument and cables not to touch the heated engine part such as exhausting area.**

Damage to the instrument and vehicle, or injury may occur.



**Be careful not to touch the heated engine part such as exhausting area when using the instrument.**

Burn injury may occur.



## OPERATING PRECAUTIONS

- This instrument is not waterproof. Keep away from the water.
- Do not polish the instrument with alcoholic fluid to avoid case cracking.
- Use the instrument under environment of  $-0^{\circ}\text{C}$  to  $40^{\circ}\text{C}$ , 70% RH or less to obtain the accurate measurement.
- Damages of insulation coating of the cables could cause dangerous short-circuit. Stop using the instrument and ask your local dealer for test lead replacement.
- Keep away from high electromagnetic environment. Damage to the instrument may occur.
- Recharge the instrument every 2 months when the instrument is out of use for a long time.
- Internal lithium battery could be damaged significantly depending on the usage or storage conditions. Failures caused by damaged battery is not warranted.

### Cautions for Handling

- Do not apply mechanical shock.  
The shock such as dropping or beating might damage the instrument and may cause the trouble.
- Do not pull cables forcibly.  
Be careful not to pull the cables forcibly when detaching them to avoid any damage such as wire disconnection.

### Cautions for Safekeeping

- Keep away the instrument from the following places.
  - Dusty area
  - The place where has the water splash
  - The place where applies the hard shock
  - $-20^{\circ}\text{C}$  or less,  $60^{\circ}\text{C}$  or more, 70%RH or more
  - The place where has the condensation
  - The place where is exposed to direct sunlight.



## UNPACKING AND INSPECTION (Check before using)

Confirm if the following items are contained in the package in good condition. If there are any damages or missing, ask your local dealer for replacement.

- ① Main Unit...1 pc.
- ② Holster...1 pc. (attached)

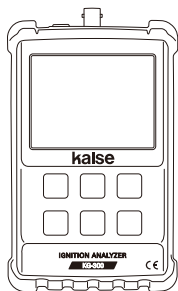

- ⑤ 672 High Tension Cord Sensor...1 pc.

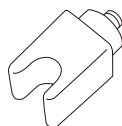

- ③ 670 Flexible Probe...1 pc.

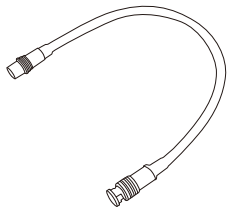

- ⑥ 933 USB Cable...1 pc.



- ④ 671 Direct Ignition Sensor...1 pc.

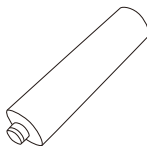

- ⑦ 1029 Carrying Case...1 pc.

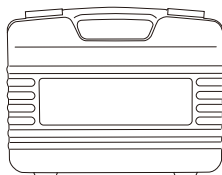

- ⑧ Instruction Manual...1 pc.

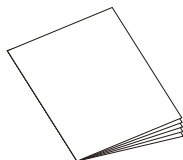

## NAME ILLUSTRATION

### ■ Main Unit

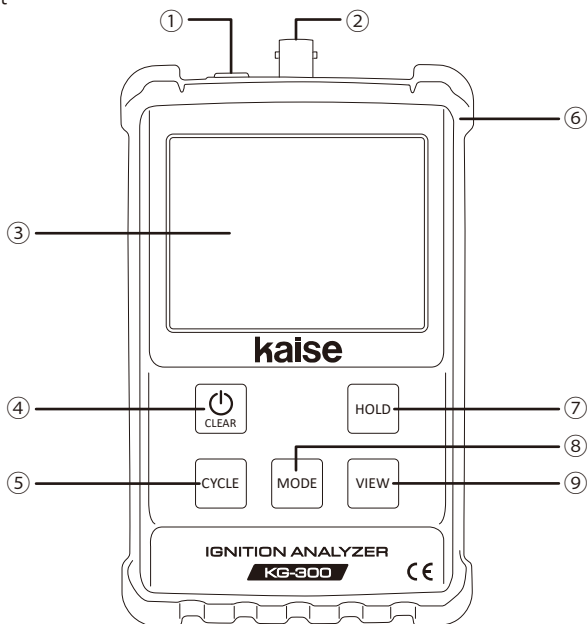

#### ① Micro USB connector :

- Connect the supplied USB cable when charging the instrument.

#### ② BNC connector :

- Connect the 670 flexible probe.

#### ③ LCD Display

#### ④ POWER / CLEAR Key

- Press this key to turn ON the instrument.
- Press and hold this key for 3 seconds or more to turn OFF the instrument.
- When the instrument is ON, press this key to clear all measurement data, and start a new measurement.

#### ⑤ CYCLE Key

- Press this key to open a pull down menu to select the number of strokes corresponding to the engine under measurement.

## NAME ILLUSTRATION

### ⑥ **Holster**

### ⑦ **HOLD Key**

- Press this key to hold the current display when chart, digital or waveform display mode is selected.
- Press this key again to resume normal operation.
- When in the comparison display mode, use this key to start and stop a measurement.

### ⑧ **MODE Key**

- Press this key to open a pull down menu to select the type of measurement.

### ⑨ **VIEW Key**

- Press this key to open a pull down menu to select how the chosen measurement will be shown in the display.

# NAME ILLUSTRATION

## ■ LCD Display

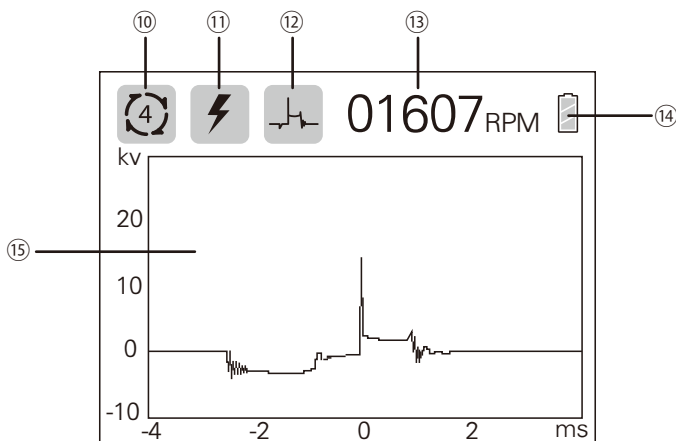

### ⑩ Engine Cycle

- This icon shows the selected Engine Cycle. (see page 13)

### ⑪ Measurement Mode

- This icon shows the selected type of measurement. (see page 15)

### ⑫ Display Mode

- This icon shows the selected display mode. (see page 16)

### ⑬ Tachometer Reading

- Digital readout of the engine RPM.

### ⑭ Battery Level Indicator

- This icon shows the state of charge of the internal battery.

Full     Empty

### ⑮ Measurement Display Area

- Current measurement is displayed corresponding to the selected display mode.

# SPECIFICATIONS

## 1. General Specifications

<b>1. LCD Display</b>	Resolution: 320×240 pixels Display area: L 53mm×W 70mm LCD type: TFT color LCD display
<b>2. Frame Rate</b>	30 times per second
<b>3. Power (internal)</b>	Rechargeable LiFePO4 battery, 3.2V/1500mAh
<b>4. Battery Life</b>	Approx. 5 hours of continuous operation (under full-charged)
<b>5. USB Connector (input)</b>	Micro USB (5V/0.5A, to recharge the internal battery)
<b>6. Auto Power Off</b>	Automatically powers off after 3 min. of inactivity
<b>7. Ignition System</b>	Direct ignition system, High tension cord type, Waste spark ignition system
<b>8. Engine Cycle</b>	2 or 4 stroke engine cycles
<b>9. Operation Temp.&amp;Humid.</b>	0 to 40°C, less than 70%rh (non-condensing)
<b>10. Storage Temp.&amp;Humid.</b>	-20 to 45°C, less than 70%rh (non-condensing)
<b>11. Altitude</b>	Less than 2000m
<b>12. Safety Level</b>	CE Marking
<b>13. Flexible Probe Length</b>	Approx. 34cm (including sensor)
<b>14. Dimensions</b>	160mm (H) ×99mm (W) ×34mm (D) (without probe)
<b>15. Weight</b>	330g (without probe)
<b>16. Accessories</b>	670 Flexible Probe, 671 Direct Ignition Sensor, 672 High Tension Cord Sensor, 933 USB Cable, Instruction Manual, 1029 Carrying Case

## 2. Measurement Specifications

Measurement Mode	Measurement Range	Accuracy	Resolution
Tachometer	400 to 19,999rpm	0.5% ± 1dgt	1rpm
Spark Plug Voltage	0 to 50kV	—	0.01kV
Spark Burn time	0 to 10ms	±0.15ms + 1dgt	0.01ms
Dwell	4 stroke 0 to 270° (600rpm<)	±1.2%×krpm±1dgt	0.1°
Angle	2 stroke 0 to 180° (750rpm<)		
Primary Current Ramp Time	0 to 10ms	±0.2ms + 1dgt	0.01ms

# MEASUREMENT PROCEDURES

## **WARNING / CAUTION**

To avoid any injuries and damage to the instrument, strictly observe the WARNINGS and CAUTIONS in pages 1 to 6.

### 1. Flexible Probe and Sensor Setup

- ① Connect the probe to the instrument using their BNC connectors. Turn the dial until locked.
- ② Insert the appropriate sensor to the probe tip.

#### ■ Direct Ignition

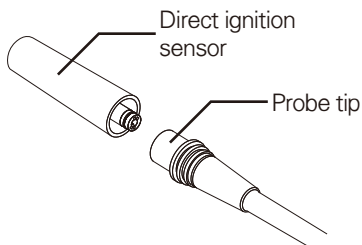

#### ■ High Tension Cord

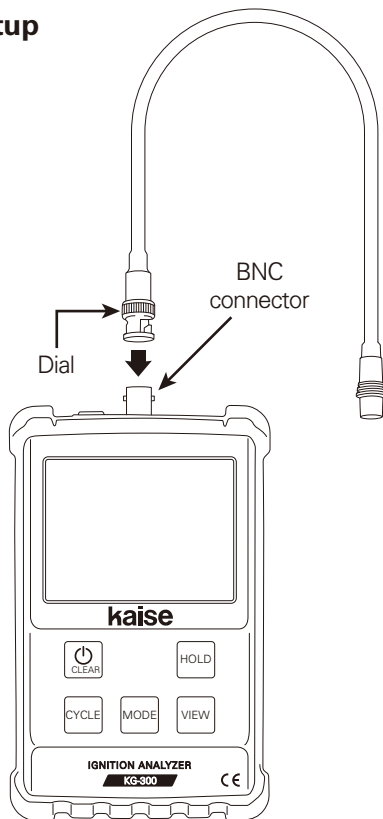
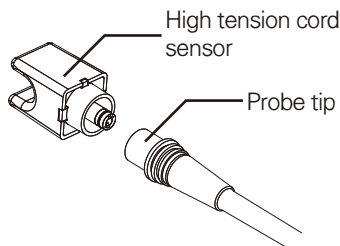

# MEASUREMENT PROCEDURES

## 2. Engine Cycle Setting

Select the number of strokes corresponding to the engine to be measured.

- ① Press POWER Key to turn on the instrument.
- ② Press CYCLE Key. Pull down menu will open with the current setting highlighted.

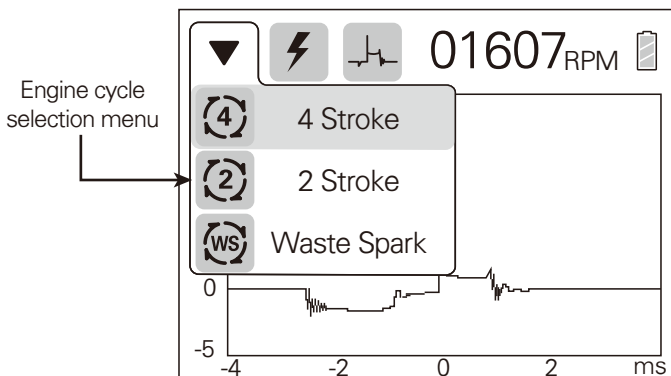

- ③ Press CYCLE Key repeatedly until the correct setting is highlighted.



4 stroke engine cycle



2 stroke engine cycle



Waste spark ignition system

- ④ Wait until the pull down menu closes. The new setting is displayed on the screen.

# MEASUREMENT PROCEDURES

## 3. Start Measurement

- ① Start an engine to be measured.
- ② Place the sensor as follows.

### ■ Measuring Direct Ignition System

Place the sensor on the top and center of the ignition module.

※ Reposition the sensor if the instrument is unable to detect the signal.

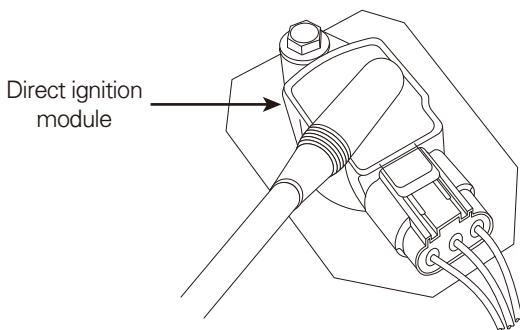

### ■ Measuring with High Tension Cords

Place the high tension cord into the slot of the sensor.

※ If the tachometer reading is unstable, reposition the sensor as far as possible from other high tension cords.

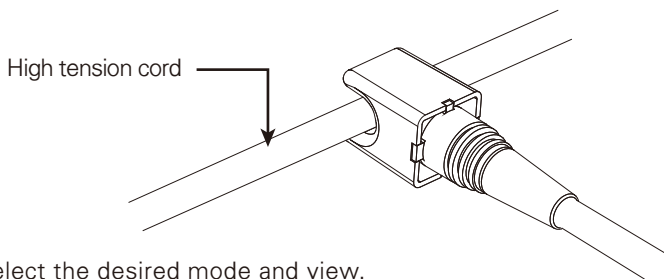

- ③ Select the desired mode and view.
  - Measurement mode setting : see page 15
  - Display mode setting : see page 16
- ④ Current measurement is displayed on the screen.



# MEASUREMENT PROCEDURES

## 4. Measurement Mode Setting

Select the type of measurement to be shown in the display.

- ① Press MODE Key under the instrument is ON. Pull down menu will open with the current setting highlighted.

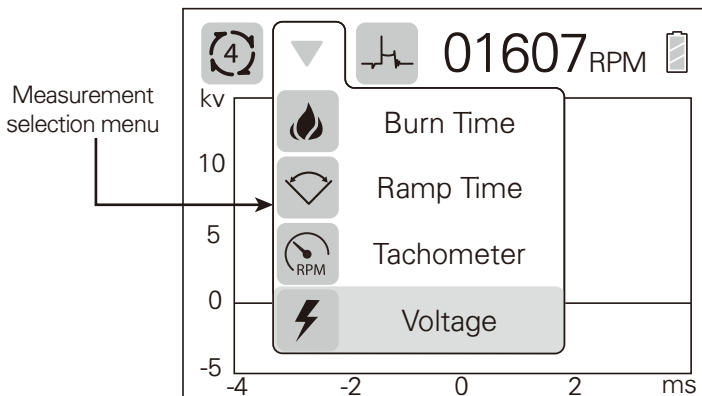

- ② Press MODE Key repeatedly until the desired setting is highlighted.



### **Burn Time (Firing Time)**

Measuring the period from a spark is started to extinguished.  
(Misfire might be occur even when burn time is measured.)



### **Ramp Time (Dwell : when using high tension code sensor)**

Measuring the period from primary coil current first begins to increase to when it stops increasing.



### **Tachometer**

Measuring RPM for 4 stroke / 2 stroke / Waste Spark engines.



### **Voltage**

Measuring spark plug voltages.

(Secondary firing voltage level to compare the performance of the ignition system between cylinders. Not the actual voltage.)

- ③ Wait until the menu closes. The new setting is displayed on the screen.

# MEASUREMENT PROCEDURES

## 5. Display Mode Setting

Select how the chosen measurement will be shown in the display.

- ① Press VIEW Key under the instrument is ON. Pull down menu will open with the current setting highlighted.

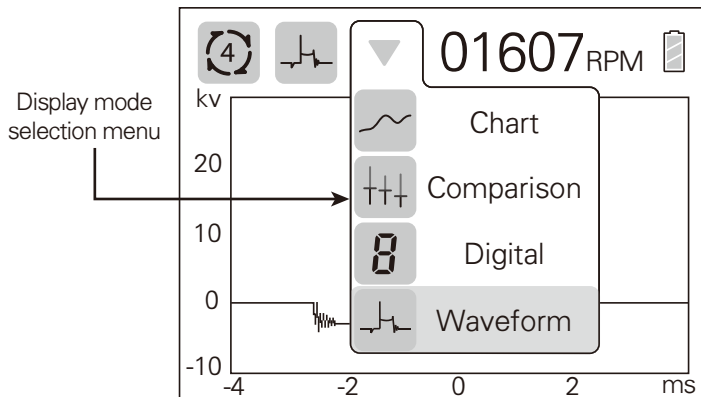

- ② Press VIEW Key repeatedly until the desired setting is highlighted.



### **Chart (i.e. trend line) view**

Displays the measurement value as the time-series chart. This view is useful to check the variability over time.



### **Comparison view**

This view is useful to compare the sets of minimum, average, and maximum values between several cylinders.



### **Digital view**

This view provides digital and analog readouts for the selected measurement, as well as the other two digital readouts.



### **Waveform (i.e. oscilloscope) view**

This view displays the signal amplitude over time (like an oscilloscope). Useful for visually checking.

- ③ Wait until the menu closes. The new setting is displayed on the screen.

# MEASUREMENT PROCEDURES

## ■ Chart view

This mode can display the measurement value as the time-series chart.

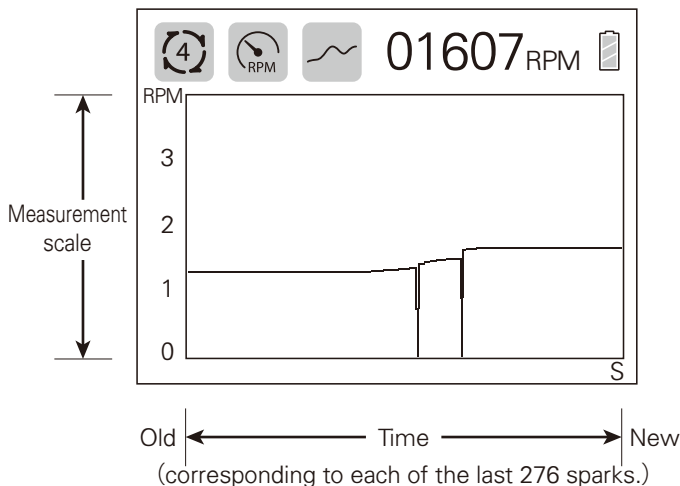

- POWER / CLEAR Key : Press to clear all values in the chart.
- MODE Key : Press to change the measurement mode.
- HOLD Key : Press to hold the display in its current condition. Press again to resume normal measurement.

※When displaying “Tachometer”, measurement scale (vertical axis) just shows the first digit of the RPM. Read the scale with thousandfold. (e.g. RPM measurement scale is “2” = 2000 RPM actually)

## MEASUREMENT PROCEDURES

### ■ Comparison view

This mode can display the comparison of sets of values (minimum, average, and maximum measurements) between several cylinders.

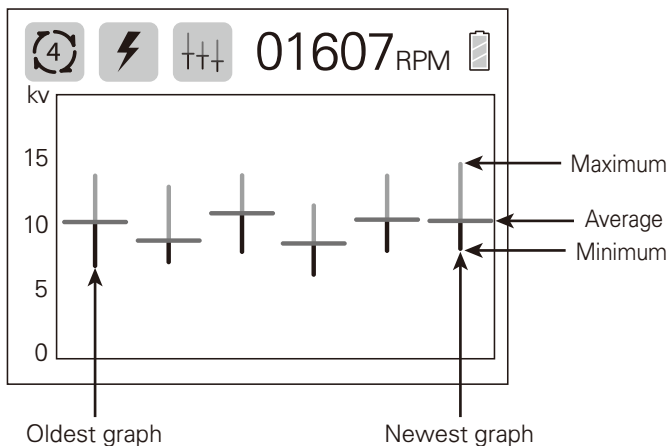

- **HOLD Key** : Press to hold the display in its current condition ("HOLD" appears on the screen). Press again to restart the measurement, and add a new graph at the right of the screen.
  - **POWER / CLEAR Key** : Press to clear all values in the chart.
  - **MODE Key** : Press to change the measurement mode.
- ※When comparing the cylinders, place the sensor on the same position of each ignition module, and in the same way.

## MEASUREMENT PROCEDURES

### ■ Digital view

This mode can display digital and analog gauge readouts for the selected measurement, as well as the other two digital readouts.

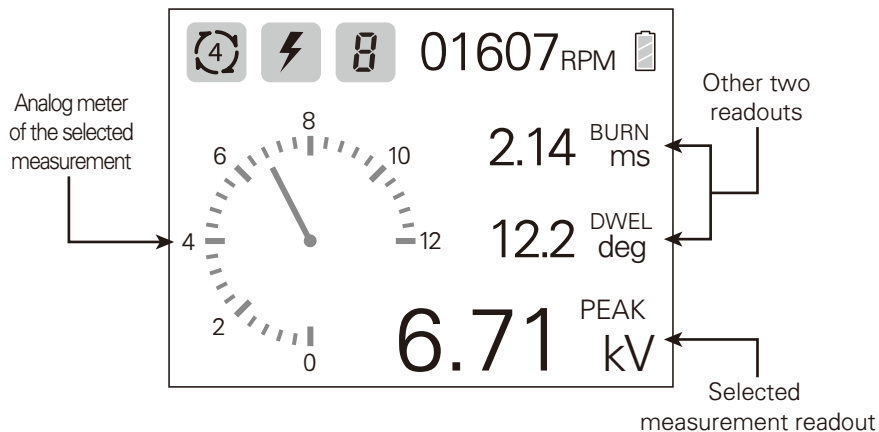

- POWER / CLEAR Key : Press to re-scale the analog meter gauge.
- MODE Key : Press to change the measurement mode.
- HOLD Key : Press to hold the display in its current condition. Press again to resume normal measurement.

※Software version of this instrument is displayed at the top of the screen when “Tachometer” measurement mode is selected.

# MEASUREMENT PROCEDURES

## ■ Waveform view

This mode can display the signal amplitude over time like an oscilloscope.

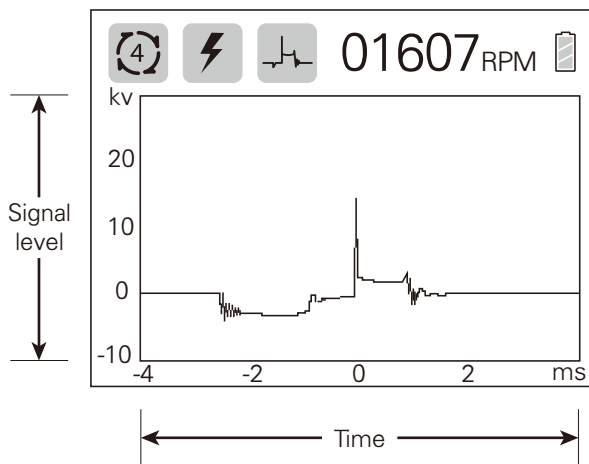

- POWER / CLEAR Key : Press to re-scale the waveform gauge.
- MODE Key : Press to change the measurement mode.
- HOLD Key : Press to hold the display in its current condition. Press again to resume normal measurement.

※Waveform related to the selected measurement mode is displayed on the screen. To display the whole image, select “Voltage” or “Tachometer” measurement mode.

※When the waveform is bigger than the present scale, press POWER / CLEAR Key to re-scale the time and signal level axes.

# MEASUREMENT EXAMPLES

## 1. Normal Ignition Coil Waveform

- **Measurement mode** : Voltage
- **Display mode** : Waveform

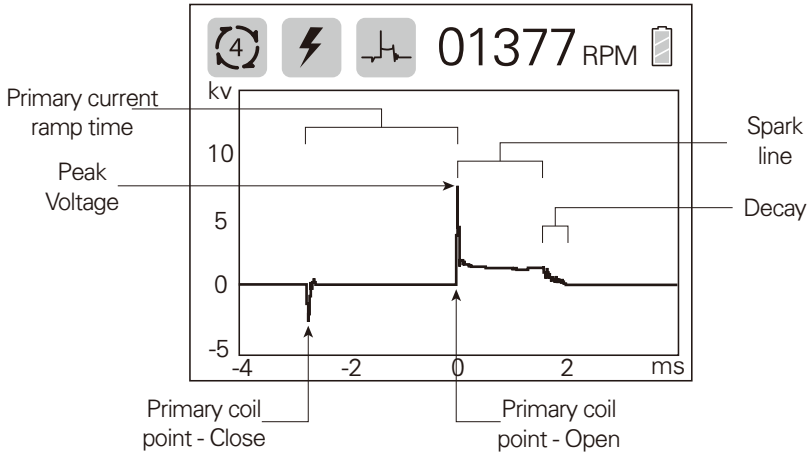

## 2. Failure Ignition Coil Waveforms

### ■ High peak voltage

- **Measurement mode** : Voltage
- **Display mode** : Waveform

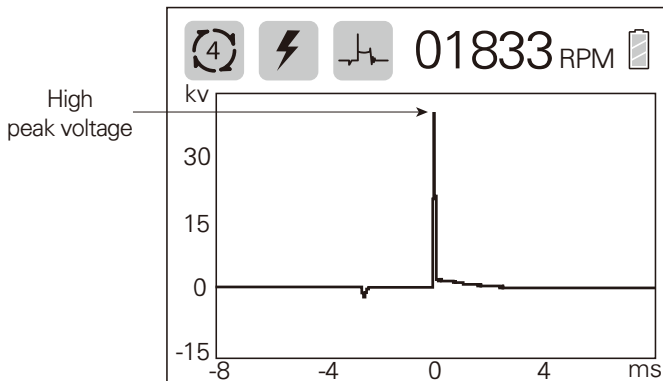

# MEASUREMENT EXAMPLES

## ■ Higher voltage than other cylinders

● **Measurement mode** : Voltage ● **Display mode** : Chart

2nd cylinder shows abnormal voltage when measuring spark plug voltage of 3-cylinders engine in chart view.

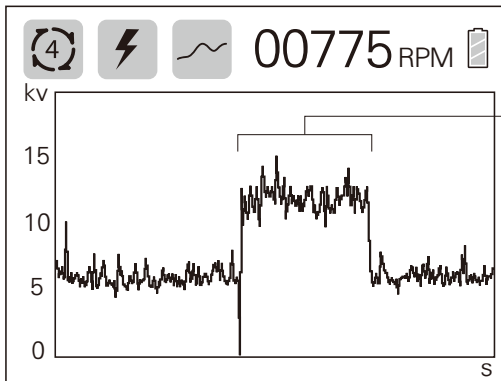

## ■ Large burn time amplitude than other cylinders

● **Measurement mode** : Burn Time ● **Display mode** : Chart

3rd cylinder shows abnormal amplitude when measuring spark burn time of 4-cylinders engine in chart view.

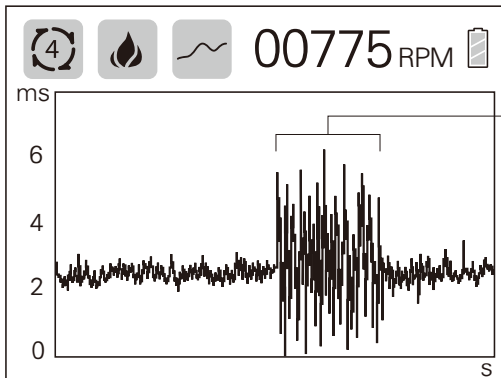



## MEASUREMENT EXAMPLES

### ■ Large maximum to minimum range with high voltage value

- Measurement mode : Voltage
- Display mode : Comparison

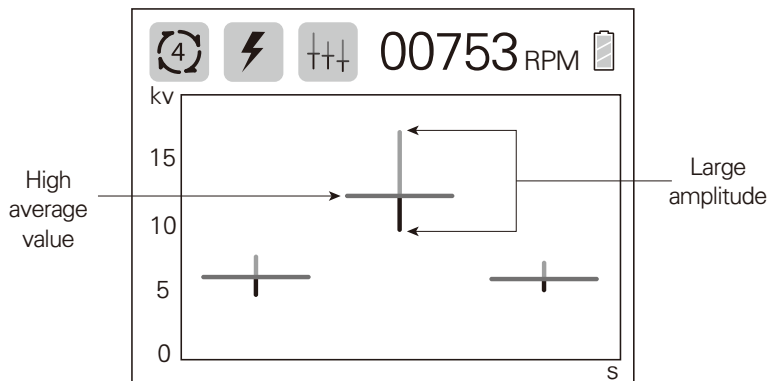

### ■ Large maximum to minimum range with short burn time

- Measurement mode : Burn Time
- Display mode : Comparison

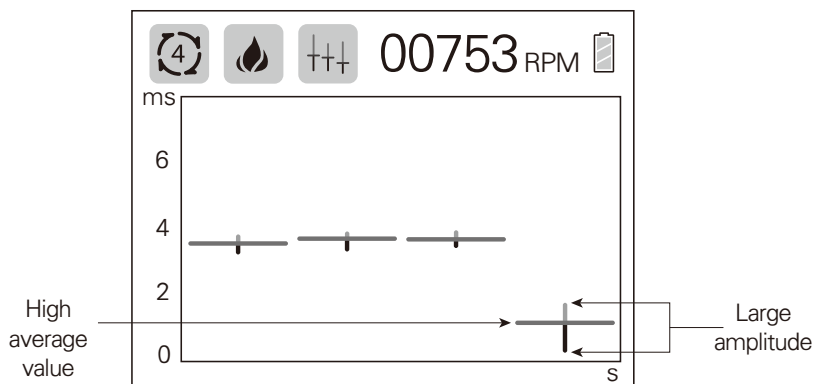

# MAINTENANCE

## 1. Recharging the Instrument

### **WARNING / CAUTION**

To avoid any injuries and damage to the instrument, strictly observe the WARNINGS and CAUTIONS in pages 1 to 6.

When battery level is low, recharge the instrument as below procedures.

- ① Turn the instrument power off.
- ② Insert the USB type A connector of 933 USB Cable into the port of the USB power adapter.

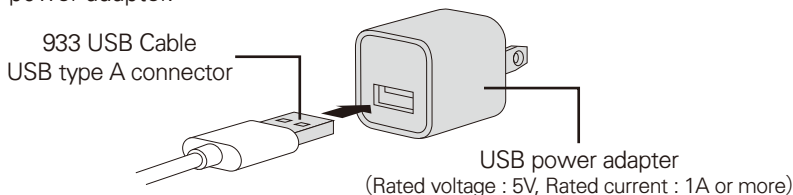

**USB power adapter is not supplied. Please prepare at your side.**

- ③ Open the rubber cap located besides the BNC connector.
- ④ Insert the micro USB plug of 933 USB Cable firmly into the receptacle of the instrument.

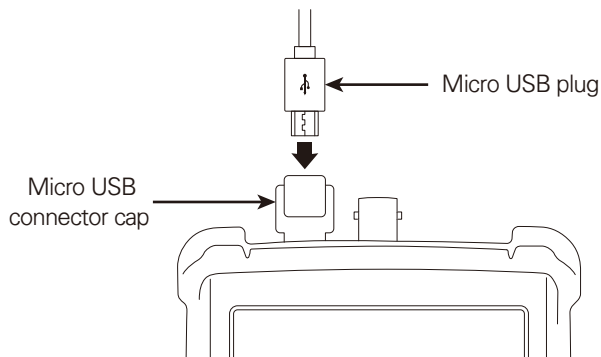

## MAINTENANCE

- ⑤ Plug the power adapter into an AC power outlet.
- ⑥ Upon start of charging the battery, the display will show the charging in process icon and the screen will turn off after a few seconds.
- ※ Press POWER / CLEAR Key to turn on again.
- ※ Measurement or other operation are prohibited while charging.

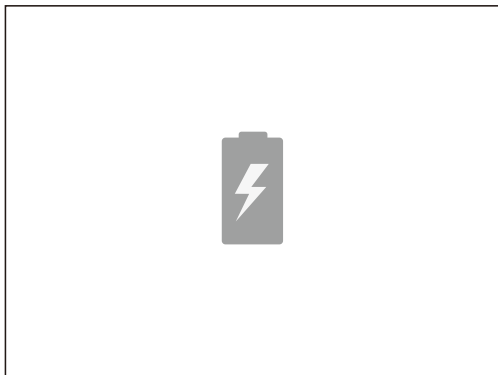

Charging in progress

- ⑦ Upon the battery is fully charged, the display will show the charging complete icon. Press POWER / CLEAR Key to confirm the icon.

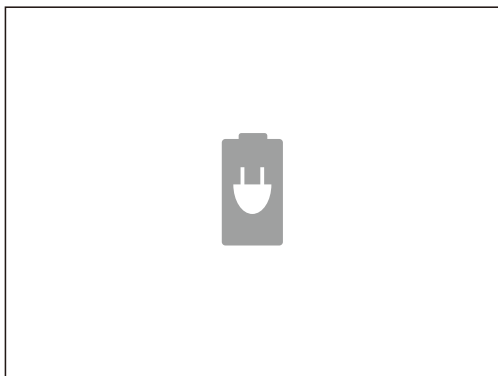

Charging complete

- ⑧ Unplug the power adapter, and disconnect the cables.

## TROUBLE SHOOTING

If there are any failure with this instrument, check the following trouble shoots before asking repair service.

Ask KAISE CORPORATION AUTHORIZED SERVICE AGENCY through your local dealer when there are any questions or troubles with this instrument.

Problem	Possible Cause & Suggested Correction
<b>Cannot turn on</b>	<ul style="list-style-type: none"><li>● Low battery power. → Recharge the internal battery. See page 24.</li></ul>
<b>No ignition signal detected</b>	<ul style="list-style-type: none"><li>● Loose connection of flexible probe or sensor. → Be sure to insert all the way.</li><li>● Sensor position is inappropriate. → Reposition the sensor.</li></ul>
<b>Cannot charge the battery</b>	<ul style="list-style-type: none"><li>● Loose connection of USB cable or USB power adapter. → Be sure to insert all the way.</li></ul>
<b>Measurement is unstable</b>	<ul style="list-style-type: none"><li>● High tension cords are crowded. → Separate the high tension cords as far as possible.</li><li>● Sensor position is inappropriate. → Reposition the sensor.</li></ul>

## ABOUT KAISE WEBSITE

Visit our website for more products information :

### **1. Kaise Corporation Website**

<https://www.kaise.com>



### **2. KG-300 Product Page URL**

[https://www.kaise.com/e\\_car\\_kg300.html](https://www.kaise.com/e_car_kg300.html)



## **WARRANTY**

KG-300 is warranted in its entirety against any defects of material or workmanship under normal use and service within a period of one year from the date of purchase of the original purchaser. Warranty service is available at KAISE AUTHORIZED SERVICE AGENCY through your local dealer. Their obligation under this warranty is limited to repairing or replacing KG-300 returned intact or in warrantable defect with proof of purchase and transport charges prepaid. KAISE AUTHORIZED DEALER and the manufacturer, KAISE CORPORATION, shall not be liable for any consequential damages, loss or otherwise. The foregoing warranty is exclusive and in lieu of all other warranties including any warranty of merchantability, whether expressed or implied.

This warranty shall not apply to any instrument or other article of equipment which shall have been repaired or altered outside of KAISE AUTHORIZED SERVICE AGENCY, nor which have been subject to misuse, negligence, accident, incorrect repair by users, or any installation or use not in accordance with instructions provided by the manufacturer.

www.kaise.com



KAISE AUTHORIZED DEALER

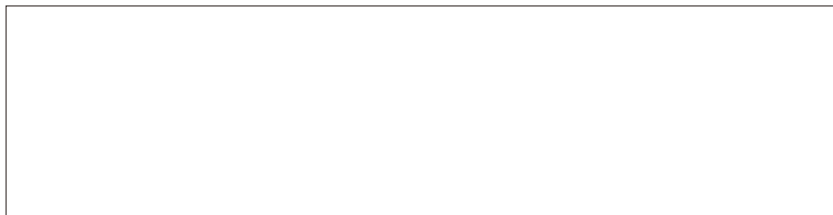

## KAISE CORPORATION

# kaise

422 Hayashinogo, Ueda City, Nagano Pref., 386-0156 Japan

TEL : +81-268-35-1601 / FAX : +81-268-35-1603

E-mail : sales@kaise.com

<http://www.kaise.com>

Product specifications and appearance are subject to change without notice due to continual improvements.

70-1201-K300-1 1909