

# kaise

## HANDY OSCILLOSCOPE

### SK-2500

### Instruction Manual



KAISE CORPORATION

Thank you very much for purchasing "HANDY OSCILLOSCOPE SK-2500".  
Read this Instruction Manual carefully to obtain the maximum performance of this instrument and to make take safe measurement.



## CONTENTS

<b>SAFETY PRECAUTIONS</b> .....	1~5
<b>OPERATING PRECAUTIONS</b> .....	6
<b>UNPACKING AND INSPECTION</b> .....	7
<b>SPECIFICATIONS</b>	
1. General Specifications .....	8
2. Measurement Specifications .....	9~10
3. Graph Display Specifications .....	11
4. Data Logger Specifications .....	11
<b>NAME ILLUSTRATION</b>	
1. Front Side .....	12~14
2. Top Side .....	14
3. Right Side .....	15
4. Rear Side .....	15
5. 100-57 Test Leads .....	16
6. 903 AC/DC Adapter (USB 5V output) .....	16
7. 934 USB Cable .....	16
<b>PRIOR TO USE</b>	
1. How to Install Batteries .....	17
2. Calendar and Language Settings .....	17
3. Protection Film .....	18
<b>GRAPH MODE</b>	
1. Screen Display .....	19~20
2. Viewing Waveform (1-channel) .....	21
3. Automatic Waveform Adjustment .....	22
4. Car Maintenance List .....	23
5. Viewing Waveform (2 channels) .....	24~25
6. Holding (HOLD) / Running (RUN) the Waveform .....	26
7. Moving the Waveform .....	27
8. Triggering on Waveform .....	28~29
9. Trigger Hold .....	30~31
10. Using Cursors .....	32~37
11. Using Clamp Adapter (Optional) .....	38~39
<b>DMM MODE</b>	
1. Screen Display .....	40~41
2. DC Voltage Measurement ( $\overline{=}$ V) .....	42~43
3. Resistance Measurement ( $\Omega$ ) .....	43~44
4. Continuity Test ( $\bullet$ )) .....	44
5. AC Voltage Measurement ( $\sim$ V) .....	44~45
6. Frequency Measurement (Hz) .....	45
7. Duty Cycle Measurement (%) .....	46
8. Pulse Width Measurement (S) .....	46
9. Temperature Measurement ( $^{\circ}$ C) .....	47
<b>DATA LOGGING / CAPTURE</b>	
1. Data Logger .....	48~49
2. Screen Capture .....	49
<b>HELP FUNCTION</b> .....	50
<b>SETTINGS - MENU SCREEN</b>	
1. Graph Set Up .....	51
2. Trigger Set Up .....	52
3. Data Logger Set Up .....	53~56
4. Removable Disk Space .....	57
5. Removable Disk Formatting .....	57
6. USB Removable Disk Set Up .....	58
7. Recall Captured Data .....	58
8. Delete Capture/Log Data .....	59
9. Contrast Set Up .....	59
10. Back Light Set Up .....	59
11. Auto Power Off .....	60
12. Calendar Set Up .....	60
13. Language Set Up .....	60
14. System Information .....	60
<b>PC CONNECTION</b> .....	61~62
<b>MAINTENANCE</b>	
1. Battery Replacement .....	63
2. Periodical Check and Calibration .....	64
3. Backup Battery .....	64
<b>SOFTWARE UPGRADE</b> .....	64
<b>TROUBLE SHOOTING</b> .....	65
<b>WARRANTY</b> .....	65



## **SAFETY PRECAUTIONS** (strict observance is required)

This instruction manual contains the important contents to prevent harm to user or others and damage of property, and to use the instrument safely and correctly. Read this manual carefully and obey the contents after having understand the following terms and symbols.

■Following symbols in this manual describe the harm and damage that would be caused by incorrect usage.

 <b>WARNING</b>	This symbol in this manual advises the user of an electrical shock hazard that could result in serious injury or even death.
 <b>CAUTION</b>	This symbol in this manual advises the user of an electrical shock hazard that could cause injury or material damages.

■Caution marks that require your attention. (equivalent marks have the same meanings.)

	Warnings and cautions that require your attentions.
	Prohibited matters to protect the user and the product.
	Mandatory matters that we ask to comply with.

## SAFETY PRECAUTIONS (strict observance is required)

### **WARNING**

#### **Checks of Body and Test Lead**

Before measurement, confirm there are no damage on the body of this instrument and handle insulators and cables of the Test Leads. Dust, grease and moisture must be removed.



#### **Prohibition of High Power Line Measurement**

Do not measure High Power Line (High Energy Circuits) such as Distribution Transformers, Bus Bars and Large Motors. High Power Line sometimes includes High Surge Voltage that could cause explosive short in the instrument and could result in shock hazard. Generally, shock hazard could occur when the current between the circuit, that involves more than 30V AC or 42.4V DC, and ground goes up to 0.5mA or more.



#### **Warning for High Voltage Measurement**

Even for Low Power Circuits of electric/electronic appliances, High Voltage Measurements are very dangerous. To avoid electric shock hazard, be sure not to touch any part of the circuit.



#### **Warning for Dangerous Voltage Measurement**

Follow these steps when measuring high voltage circuit.

- ① Turn off the circuit to be measured.
- ② Press POWER Key to turn on the instrument.
- ③ Insert black & red test lead to the input terminals.
- ④ Attach Alligator Clips (option) to the both red and black test pins.
- ⑤ Connect black alligator clip to Earth side (–), and red one to positive (+) side after verifying that the circuit to be measured is turned off.
- ⑥ Place the instrument stably without holding your hands. Keep safety distance from the circuit to be measured not to touch your hands, body, or test leads.
- ⑦ Turn on the circuit to be measured. See the readings on the screen.
- ⑧ Turn off the circuit to be measured. Detach red and black alligator clips from the circuit.



#### **When measuring live-line, strictly observe the warnings below :**

- ① Wear insulated gloves.
- ② Place the instrument stably without holding your hands.
- ③ Press POWER Key to turn on the instrument.
- ④ Insert black & red test lead to the input terminals.
- ⑤ Attach Alligator Clip (option) to black test pin. Connect it to Earth side (–) of the circuit to be measured.
- ⑥ Keep safety distance from the circuit to touch your hands, body, or test leads.
- ⑦ Contact red test pin to positive (+) side of the circuit to be measured.
- ⑧ See the readings on the screen.
- ⑨ Detach red test pin first, then detach black alligator clip from the circuit.



## SAFETY PRECAUTIONS (strict observance is required)

### **WARNING**

**Use in well-ventilated place.**

If improperly vented, exhaust gas may cause carbon monoxide poisoning.



**Put the vehicle in Parking gear (in Neutral gear for stick-shift vehicle).**

Car may run accidentally and could cause unexpected accident, electric shock, fire or damage to the instrument or to the vehicle.



**Apply parking brake.**

Car may run accidentally and could cause unexpected accident, electric shock, fire or damage to the instrument or to the vehicle.



**Keep the instrument away from babies or children.**

To prevent unexpected accident, injury, or electric shock hazard.



**Detach test leads from the measuring circuit when changing the measurement function, opening battery cover, or connecting to PC.**

Fire, electric shock, or damage to the instrument may occur.



**Do not use the instrument with wet hands.**

Accident, electric shock, fire, or damage to the instrument or the vehicle may occur.



**Do not use near the inflammable materials such as gasoline or oil.**

Fire or explosion may occur.



**Do not drive the vehicle keeping the instrument connected.**

Accident, electric shock, fire, or damage to the instrument or the vehicle may occur.



**Do not use in the dark place.**

Accident, electric shock, fire, or damage to the instrument or the vehicle may occur.



**Do not get the instrument wet.**

Fire, or electric shock may occur.



**Do not use the instrument or its accessories in case of any damage.**

If you find any damage, immediately stop using the instrument and consult with your local dealer. Using the faulty instrument may cause the unexpected accident, fire, or electric shock.



**Do not touch USB terminal or not insert foreign object.**

Accident, electric shock, fire, or damage to the instrument may occur.



**Do not place the instrument in any place where it will be subjected to direct sunlight or high temperatures or in the sun-heated vehicle.**

Fire, electric shock, or damage to the instrument may occur.



**Do not touch heated part of the engine such as exhausting parts.**

To prevent burn injury.



## SAFETY PRECAUTIONS (strict observance is required)

### **WARNING**

**Be careful about your hands, gloves, and cloths not to be caught in the engine belt or cooling fan.**

To prevent unexpected injury.



**Do not use the instrument if it is in the abnormal condition.**

Stop using immediately and consult with your local dealer when recognizing smoke, strange smell, or abnormal noise. Using the faulty instrument may cause the unexpected accident, fire, or electric shock.



**Do not attempt to disassemble or modify the instrument.**

Fire, electric shock, or damage to the instrument may occur.



**Do not use the test leads with its insulation coating damaged.**

Fire, electric shock, or damage to the instrument may occur.



**DMM mode : Do not apply voltage in other functions except for AC/DC V.**

Fire, electric shock, or damage to the instrument may occur.



**Do not measure any elements that might exceed the specified maximum input values.**

Fire, electric shock, or damage to the instrument may occur.



**Children and the persons who do not have enough knowledge about electric measurements must not use this instrument.**

Fire, electric shock, or damage to the instrument may occur.



**Do not use the instrument in naked or barefooted.**

Fire, electric shock, or damage to the instrument may occur.



**Do not point the test pins to someone.**

Blindness or unexpected injury may occur.



**Do not make measurement when connecting to PC.**

Fire, electric shock, or damage to the instrument may occur.



**Do not open battery cover during measurement or PC connection.**

Electric shock may occur.



**Do not replace the batteries with wet hands.**

Electric shock may occur.



**Do not attempt to heat, disassemble the batteries.**

**Do not put them in fire or water.**

Battery bursting or electrolyte leakage may cause fire or unexpected injury.



## SAFETY PRECAUTIONS (strict observance is required)

### CAUTION

**Be careful about the instrument or test lead not to be caught in the engine belt or cooling fan, or not to touch the heated engine part such as exhausting area.**

Short-circuit or cable disconnection may cause unexpected accident, electric shock, fire or damage to the instrument or to the vehicle.



**Do not apply mechanical shock to the instrument. Do not drop off the instrument.**

Damage to the instrument may occur.



**Do not hit, thrust and make scratch on the LCD display part.**

Trouble or damage to the LCD could cause.



**Do not use other USB cable except the supplied one.**

Damage to the instrument or to PC may occur.



**Do not use the instrument with power supply from cigarette car charger.**

Damage to the instrument or to the vehicle may occur.



**Use the specified batteries only.**

Battery bursting or electrolyte leakage may cause fire or unexpected injury.



**Put the batteries with correct polarity.  
(see pictorial plus ⊕ and minus ⊖ indications in the battery case).**

Incorrect polarity could cause fire, or unexpected injury due to battery bursting or electrolyte leakage.



**Discard the batteries properly. Tape up plus ⊕ and minus ⊖ terminals and make them insulated.**

Fire or battery bursting may occur due to short-circuit with other electrically-conductive materials.



**Use the provided "903 AC/DC Adapter (USB 5V output)" when using power supply from wall outlet.**

Damage to the instrument may occur.



## OPERATING PRECAUTIONS

- Do not put engine oil or other similar fluid on test pins, input terminals or USB terminals to prevent contact failure.
- Do not apply engine oil, gasoline, antifreeze or battery fluid to the instrument to prevent any damage to the instrument surface.
- Do not polish the instrument with alcoholic fluid to prevent cracking of the case.
- Use the instrument under environment of  $-10^{\circ}\text{C}$  to  $50^{\circ}\text{C}$ , 80% RH or less to obtain the accurate measurement.
- Store the instrument under environment of  $-20^{\circ}\text{C}$  to  $60^{\circ}\text{C}$ , 70% RH or less to avoid any damage to the instrument.
- Damages of insulation coating of the test lead could cause dangerous short-circuit. Stop using the instrument and ask your local dealer for test lead replacement.
- Put the instrument and accessories into the carrying case for storing.
- Remove the batteries when the instrument is out of use for a long time. The exhausted batteries might leak electrolyte and corrode the inside.

### Cautions for Handling

- **Do not apply mechanical shock.**

The shock such as dropping or beating might damage the instrument and may cause the trouble.

- **Do not pull test leads or cables forcibly.**

Be careful not to pull USB cable or test leads forcibly when detaching them to prevent any damage such as wire disconnection.

### Cautions for Safekeeping

- Keep away the instrument from the following places.
  - Dusty area
  - The place where has the water splash
  - The place where applies the hard shock
  - $-20^{\circ}\text{C}$  or less,  $60^{\circ}\text{C}$  or more, 70%RH or more
  - The place where has the condensation
  - The place where is exposed to direct sunlight.



# UNPACKING AND INSPECTION (Check before use)

Confirm if the following items are contained in the package in good condition.  
If there are any damages or missing items, ask your local dealer for replacement.

① Main Unit (Oscilloscope)···1 pce.



② Holster (attached)···1 pce.

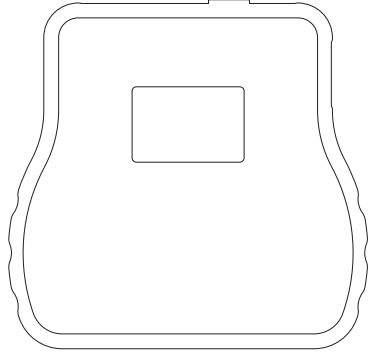

③ 100-57 Test Leads···1 set (red & black)

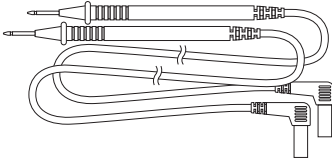

④ 903 AC/DC Adapter (USB 5V output)···1 pce.

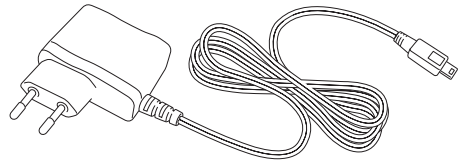

⑤ 1035 Carrying Case···1 pce.

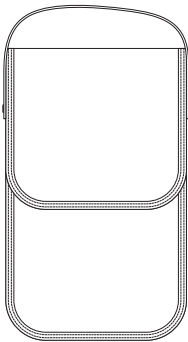

⑥ 934 USB Cable···1 pce.

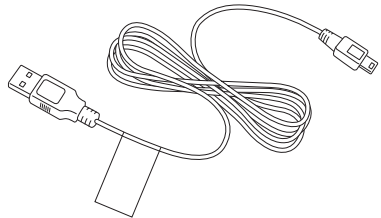

⑦ 1.5V R6P Batteries···4 pcs.

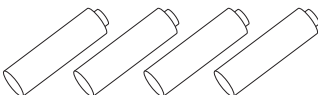

⑧ Instruction Manual···1 pce.

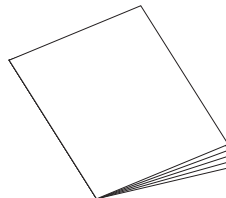

⑨ Caution Card  
···1 pce.

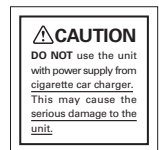

# SPECIFICATIONS

## 1. General Specifications

※Specifications and appearance are subject to change without notice.

<b>Display (LCD)</b>	Dot matrix LCD (240 × 128 dots) Display Size : 53mm(H) × 92mm(W)
<b>Display Sampling Rate</b>	Waveform : 4 times / sec., Readings : 2 times / sec.
<b>Measurement Items</b>	DC Voltage, AC Voltage, Resistance, Continuity, Frequency, Duty Cycle, Pulse Width, Temperature
<b>Frequency Bandwidth</b>	DC to 200kHz
<b>Max. Sampling Rate</b>	2MS / sec.
<b>Max. Input Voltage</b>	DC 1000V / AC (rms) 600V ※Crest factor 1.5 or less
<b>Number of Channels</b>	2 channels
<b>Input Resistance</b>	Approx. 1MΩ
<b>Language</b>	English, Japanese (Default : English)
<b>Oscilloscope Function</b>	Graphic waveform display for voltage measurement
<b>DMM Function</b>	Displays for DCV, ACV, Resistance, Continuity, Frequency, Duty Cycle, Pulse Width, Temperature
<b>Internal Power Supply</b>	1.5V LR6 or R6P batteries 4 pcs. (NiMH rechargeable battery usable)
<b>External Power Supply</b>	USB mini-B connector (DC5V)
<b>Auto Power Off</b>	Turn off after a lapse of 30 minutes (for battery operation only, default setting : OFF)
<b>Data Saving</b>	Screen capture : save "HOLD" display as image data (PNG format) Data logger : save sampling data (CSV format) ※Data saving capacity : approx. 3.7M bytes (movable to PC with USB cable)
<b>Operating Temperature &amp; Humidity</b>	−10°C to 50°C, less than 80%RH (in non-condensing)
<b>Storage Temperature &amp; Humidity</b>	−20°C to 60°C, less than 70%RH (in non-condensing)
<b>Power Consumption</b>	Backlight-ON : approx. 170mA, Backlight-OFF : approx. 100mA
<b>Continuous Measurement</b>	Manganese : 2.5 hours for backlight-ON, 4.5 hours for backlight-OFF (approx.) Alkaline, NiMH (1900mAh) : 10 hours for backlight-ON, 18 hours for backlight-OFF (approx.)
<b>Safety Level</b>	CE Marking approved (main unit) EN61010-1 CAT II 300V class 2, EN61326-1
<b>Dimensions</b>	Approx. 162mm(H) × 167mm(W) × 35mm(D)
<b>Weight</b>	Approx. 570g (excluding batteries)
<b>Accessories</b>	Holster (attached to the main unit), 100-57 Test Leads, 903 AC/DC Adapter (USB 5V output), 934 USB cable, 1035 Carrying Case, 1.5V R6P Batteries 4 pcs, Instruction Manual
<b>Optional Accessories</b>	660 AC/DC Clamp Adapter, 100-57R Red Test Lead, 100-41 Test Lead Kit, 100-62 Test Lead Set, 100-72 Oscilloscope Test Lead Set, 653 RPM Sensor (for Direct Ignition), 650 RPM Sensor (for High Tension Cord), 940 Alligator Clips, 793 Coil-Type Contact Pin, 944 Test Pin, 946 Battery Clip, 818-02 Temperature Probe

# SPECIFICATIONS

## 2. Measurement Specifications (23°C±5°C, less than 80%RH in non-condensing)

Temperature Coefficient : add "accuracy×0.1 / °C" except 23°C±5°C

Voltage (Graph mode)

Frequency bandwidth : DC to 200kHz

V / Div	Accuracy
200mV / 2V / 20V	±4dot
500mV / 5V / 50V / 200V	±2dot
1V / 10V / 100V / 500V	±1dot

※Max. sampling rate : 2MS / sec.

※DC coupling

DC Voltage (DMM mode)

Range	Accuracy	Resolution	Max. Input
200.0mV	±1.0%rdg±8dgt	100 μV	1000V DC
2.000V		1mV	
20.00V		10mV	
200.0V		100mV	
1000V	±1.0%rdg±5dgt	1V	

※Over input indication : "OL"

※Response speed : approx. 4 sec.

※Max. sampling rate : 2S / sec.

※DC coupling

※Overload protection : 1200V DC/AC (peak) for 1 min.

AC Voltage (AC V rms)

DMM mode

Range	Accuracy	Resolution	Max. Input
2.000V	±2.0%rdg±8dgt (45Hz to 1kHz)	1mV	600V AC (rms)
20.00V	±2.5%rdg±8dgt (1kHz to 10kHz)	10mV	
	±4.0%rdg±8dgt (10kHz to 20kHz)	100mV	
200.0V	±6.0%rdg±8dgt (20kHz to 30kHz)	1V	
600V	±2.0%rdg±5dgt (45Hz to 1kHz) ±2.5%rdg±5dgt (1kHz to 10kHz)		

※20.00V range : for 18V to 20V, add ±1.0% to the accuracy

※200.0V range : for 180V to 200V add ±1.0% to the accuracy, frequency effective 45Hz to 20kHz

※Over input indication : "OL"

※Max. sampling rate : 2S / sec.

※Overload protection :

※Frequency characteristics : 45Hz to 30kHz

1200V DC/AC (peak) for 1 min.

※Crest factor 1.5 or less

※Response speed : approx. 4 sec.

Resistance (Ω)

DMM mode

Range	Accuracy (specified after zero adjustment)	Resolution	Open Circuit Voltage
2.000kΩ	±1.0%rdg±8dgt	1Ω	≤3.3V
20.00kΩ		10Ω	

※Over input indication : "OL"

※Test current : approx. 75μA

※Max. sampling rate : 2S / sec.

※Response speed : approx. 7 sec.

※Overload protection : 1000V DC/AC (peak) for 1 min.

# SPECIFICATIONS

## Continuity Test ( $\cdot$ )

DMM mode

Range	Accuracy	Resolution	Open Circuit Voltage
2.000k $\Omega$	$\pm 1.0\%rdg \pm 8dgt$	1 $\Omega$	$\leq 3.3V$
	Buzzer sounds when approx. 50 $\Omega$ or less		

※Over input indication : "OL"

※Max. sampling rate : 2S / sec.

※Overload protection : 1000V DC/AC (peak) for 1 min.

※Test current : approx. 75  $\mu A$

※Response speed : buzzer : approx. 0.5 sec. / LCD : approx. 7 sec.

## Temperature (°C)

DMM mode

Range	Accuracy	Resolution	Sensor
-50°C to 220°C	$\pm 4^{\circ}C$ (10°C to 50°C)	1°C	K-type thermocouple
	$\pm 5^{\circ}C$ (-50°C to 9°C / 51°C to 220°C)		

※Over input indication : "OL"

※Accuracy excludes temp. sensor error.

※Max. sampling rate : 2S / sec.

※Accuracy specified after a lapse of 1 hour

※Overload protection : 1000V DC/AC (peak) for 1 min. or more in stable temperature.

※Response speed : approx. 7 sec.

## Frequency (Hz)

DMM mode

Range	Accuracy	Resolution	Input Sensitivity
5.00Hz to 99.99Hz	$\pm 0.2\%rdg \pm 2dgt$	0.01Hz	5V (sine wave)
100.0Hz to 999.9Hz		0.1Hz	
1.000kHz to 9.999kHz		1Hz	
10.00kHz to 99.99kHz		10Hz	

※Over input indication : "OL"

※Overload protection : 1200V DC/AC (peak) for 1 min.

## Duty Cycle (%)

DMM mode

Range	Accuracy	Resolution	Input Sensitivity
5.0% to 95.0%	$\pm 0.5\%rdg \pm 3dgt$	0.1%	5V (square wave)

※Frequency Range : 5Hz to 1kHz

※Overload protection : 1200V DC/AC (peak) for 1 min.

## Pulse Width (S)

DMM mode

Range	Accuracy	Resolution	Input Sensitivity
10 $\mu S$ to 999 $\mu S$	$\pm 0.5\%rdg \pm 3dgt$	1 $\mu S$	5V (square wave)
1.0mS to 999.9mS		0.1mS	

※Frequency Range : 5Hz to 10kHz

※Duty cycle range : 5.0% to 95.0%

※Overload protection : 1200V DC/AC (peak) for 1 min.

# SPECIFICATIONS

## 3. Graph Display Specifications

V / Div range

Range	Voltage	Max. Display Input	Range	Voltage	Max. Display Input
200mV	1dot=10mV	approx. 2V	20V	1dot=1V	approx. 200V
500mV	1dot=25mV		50V	1dot=2.5V	
1V	1dot=50mV		100V	1dot=5V	
2V	1dot=100mV	approx. 20V	200V	1dot=10V	approx. 1000V
5V	1dot=250mV		500V	1dot=25V	
10V	1dot=500mV				

※Screen shows “Over Load” when input voltage exceeds the maximum limit of each range.

Time / Div range

Range	Time	Range	Time
500ns	20dot=500ns	50ms	1dot=2.5ms
1 μs	10dot=500ns	100ms	1dot=5ms
2 μs	5dot=500ns	200ms	1dot=10ms
5 μs	2dot=500ns	500ms	1dot=25ms
10 μs	1dot=500ns	1s	1dot=50ms
20 μs	1dot=1 μs	2s	1dot=100ms
50 μs	1dot=2.5 μs	5s	1dot=250ms
100 μs	1dot=5 μs	10s	1dot=500ms
200 μs	1dot=10 μs	20s	1dot=1s
500 μs	1dot=25 μs	60s	1dot=3s
1ms	1dot=50 μs	2min	1dot=6s
2ms	1dot=100 μs	5min	1dot=15s
5ms	1dot=250 μs	10min	1dot=30s
10ms	1dot=500 μs	20min	1dot=60s
20ms	1dot=1ms		

## 4. Data Logger Specifications

Voltage (Graph mode)

Range	Accuracy
2.000V	±1.0%rdg±40dgt
20.00V	
200.0V	
1000V	±1.0%rdg±20dgt

DC Voltage (DMM mode)

Range	Accuracy
200.0mV	±1.0%rdg±20dgt
2.000V	
20.00V	
200.0V	
1000V	±1.0%rdg±10dgt

AC Voltage (DMM mode)

Range	Accuracy
2.000V	±2.0%rdg±20dgt (45Hz to 1kHz), ±2.5%rdg±20dgt (1kHz to 10kHz) ±4.0%rdg±20dgt (10kHz to 20kHz), ±6.0%rdg±20dgt (20kHz to 30kHz)
20.00V	
200.0V	
600V	±2.0%rdg±10dgt (45Hz to 1kHz), ±2.5%rdg±10dgt (1kHz to 10kHz)

※20.00V range : for 18V to 20V, add ±1.0% to the accuracy

※200.0V range : for 180V to 200V add ±1.0% to the accuracy, frequency effective 45Hz to 20kHz

# NAME ILLUSTRATION

## 1. Front Side

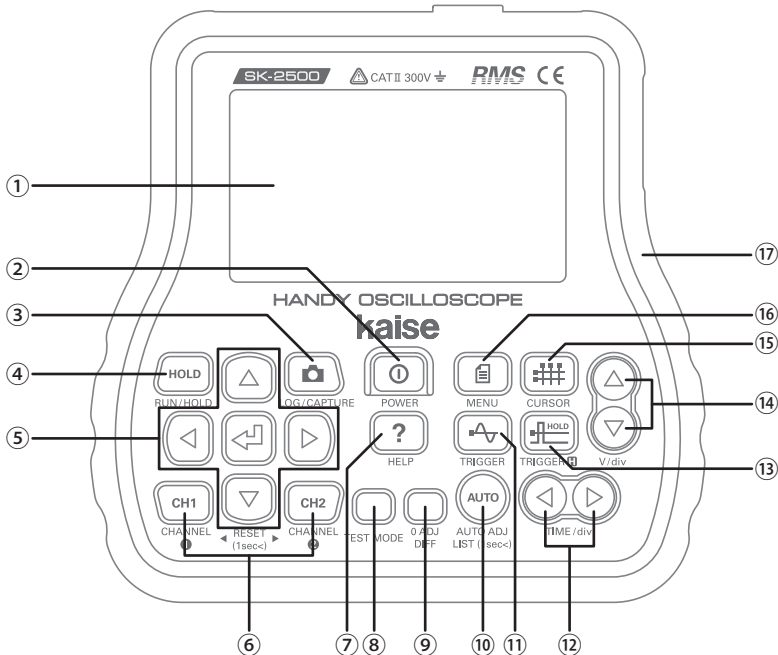

### ① Display (LCD)



### ② POWER Key :

- Turn ON / OFF the instrument.

### ③ LOG/CAPTURE Key :

- Press while measurements are running (RUN) : Start data logging.
- Press during data logging : Stop data logging.
- Press while the screen is frozen (HOLD) : Capture the screen and save as image data.

### ④ RUN/HOLD Key (HOLD Key) :

- Press while measurements are running (RUN) : Stop measurement, the screen is frozen. Key illumination ON. (  lights up LCD)
- Press while the screen is frozen (HOLD) : Re-start the measurement. Key illumination OFF. (  lights up on LCD)

### ⑤ ARROW Keys, ↵ (ENTER) Key :

- In Menu, Car Maintenance List, and Help screens : Select and decide the items.
- In Graph mode : Move display position of the waveform.
- In Graph mode : Move and fix the trigger level and cursor position.
- In DMM mode : Select measurement ranges. Use in MAX/MIN function.

## NAME ILLUSTRATION

### ⑥ CHANNEL 1 and 2 Keys (CH1, CH2 Keys) :

- Select Channel 1 or 2 to display its waveform and measurement readings. Key illumination ON for the selected channel.
- Long press in Graph mode : Reset zero voltage line of each channel.

### ⑦ HELP Key :

- Display the hints or tips in reference to the operation. Press again to go back to the previous screen.

### ⑧ TEST MODE Key :

- Press in Graph mode : Enter DMM mode.
- Press in DMM Mode : Change measurement items as below.  
DC Voltage → Resistance → Continuity → AC Voltage → Frequency → Duty Cycle → Pulse Width → Temperature → DC Voltage
- Long press in DMM mode : Back to Graph mode.

### ⑨ 0 ADJ / DIFF Key :

- Zero adjustment in Resistance ( $\Omega$ ) measurement in DMM mode : Adjust the readings when pressed the key into  $0\Omega$ . Press again to release.
- Difference measurement in DMM mode : Use in AC/DC Voltages (  $\overline{\sim}$  /  $\sim$  ) and Temperature ( $^{\circ}\text{C}$ ) measurements. The readings when pressed the key is set as criteria, and show the difference value on the screen. Press again to stop.

### ⑩ AUTO ADJ Key (AUTO Key) :

- Auto adjustment for Voltage axis (V/Div) and Time axis (Time/div).  
Analyze the measurement data of the selected channel automatically enable to display the optimized waveform.
- Long press : Open Car Maintenance List.

### ⑪ TRIGGER Key :

- Trigger level bar on voltage axis and trigger position bar on time axis are displayed.
- Press again : Hide trigger bars.

※ Trigger bars are automatically hidden after a lapse of 10 seconds of no operation.

### ⑫ TIME/div Key :

- Press Right Key in Graph mode : Rise the time axis range (Time/div).
- Press Left Key in Graph mode : Lower the time axis range (Time/div).

### ⑬ TRIGGER HOLD Key :

- Press in Graph mode : Freeze the waveform when the input exceeds the trigger level that was set with TRIGGER Key. (Key illumination ON for RUN/HOLD Key)
- Press RUN/HOLD Key : Release trigger hold.

## NAME ILLUSTRATION

### ⑭V/div Key :

- Press Up Key in Graph mode : Raise the voltage axis range (V/div).
- Press Down Key in Graph mode : Lower the voltage axis range (V/div).

### ⑮CURSOR Key :

- Press in Graph mode : Display A and B cursors.
- Press again : Display C and D cursors.
- Press again : RPM measurement between C and D cursors for 4-stroke engine.
- Press again : RPM measurement between C and D cursors for 2-stroke engine.
- Press again : Duty cycle measurement with C, D, and E cursors.
- Press again : Hide the cursors.

※Long press in Cursor mode : Hide the all cursors.

### ⑯MENU Key :

- Open Menu screen. Press again to close.

### ⑰Rubber Holster :

- Safety cover to protect the instrument from shock and unexpected slip.

## 2. Top Side

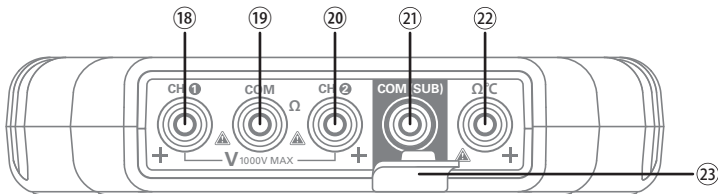

### ⑱CH1 Plus (+) Input Terminal :

- Insert Red test lead plug.

### ⑲Minus (-) Input Terminal (COM Terminal) :

- Insert Black test lead plug.

### ⑳CH2 Plus (+) Input Terminal :

- Insert optional Red test lead plug when making 2-channels measurement.

### ㉑Sub-Minus (-) Input Terminal (COM (SUB) Terminal) :

- 2-channels measurement : Use for optional accessories.
- Temperature Measurement : Insert minus (-) plug of 818-02 Temperature Probe (option).

### ㉒Ω°C Plus Input Terminal :

- Resistance Measurement : Insert Red test lead plug.
- Temperature Measurement : Insert (+) plug of 818-02 Temperature Probe (option).

### ㉓Safety Cover :

- Protect wrong insertion. Flip open to use COM (SUB) terminal.



# NAME ILLUSTRATION

## 3. Right Side

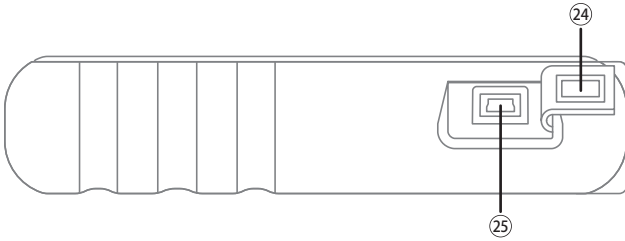

### ②④ USB Terminal Cover :

- Flip open to use USB terminal.

### ②⑤ USB Terminal :

- PC Connection : Insert the connector of 934 USB cable.
- Using power supply from wall outlet : Insert USB connector of 903 AC/DC Adapter (USB 5V output).

## 4. Rear Side (holster removed)

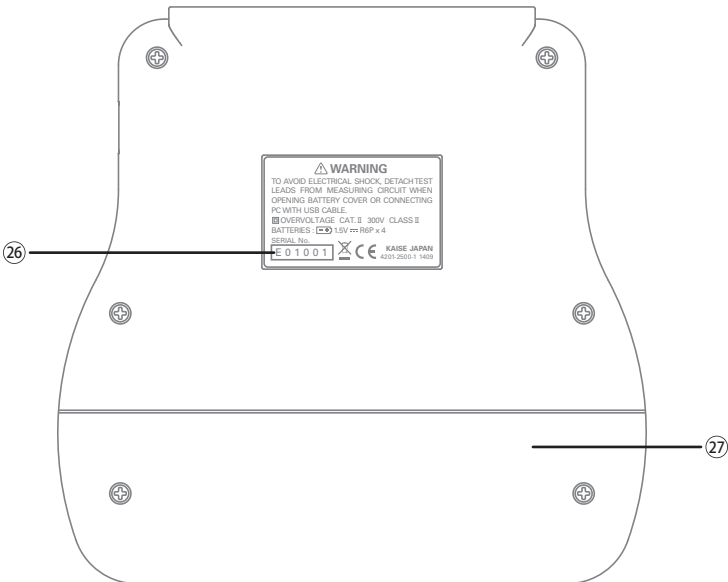

### ②⑥ Serial Number :

- The number assigned for identification of a single unit.

### ②⑦ Battery Cover :

- Open this cover when replacing the batteries.

## NAME ILLUSTRATION

### 5. 100-57 Test Leads

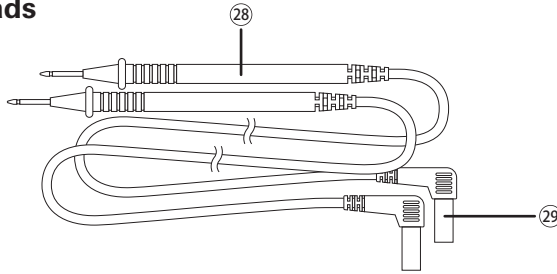

#### ②⑧ Test Prods :

- Hold in your hands and contact the metal pins on the object to be measured.

#### ②⑨ Input Plugs :

- Insert to input terminals of the instrument.

### 6. 903 AC/DC Adapter (USB 5V output)

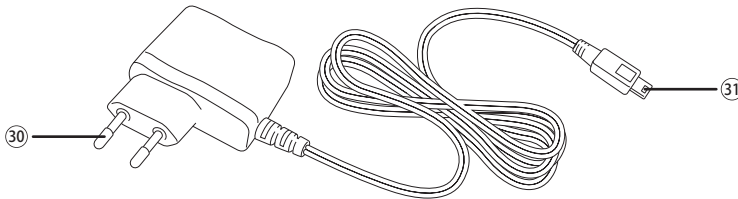

#### ③⑩ Power Plug :

- Insert to wall outlet. Applicable to 100V to 240V AC.

#### ③① MiniB USB Connector :

- Insert to USB terminal of the instrument.

### 7. 934 USB Cable

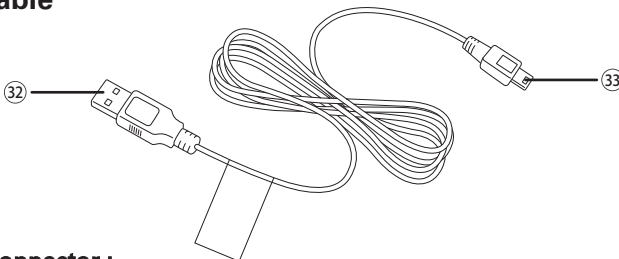

#### ③② USB A-type Connector :

- Insert USB terminal of the PC.

#### ③③ MiniB USB Connector :

- Insert USB terminal of the instrument.

# PRIOR TO USE

## 1. How to Install Batteries



**WARNING**

Read "SAFETY PRECAUTIONS" in pages 1 to 6 carefully before installing the batteries. Strictly observe the warnings and cautions.

**Install the provided batteries into the instrument before use.**

- ① Remove rubber holster. Loosen two-screws, and open the battery cover.
- ② Install the provided four batteries with the correct polarity as plus ⊕ and minus ⊖ pictorial indications.
- ③ Fix the battery cover and tighten the screws. Put rubber holster over the instrument.

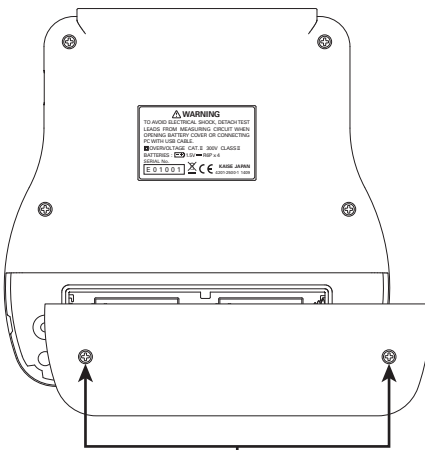

Loosen the screws

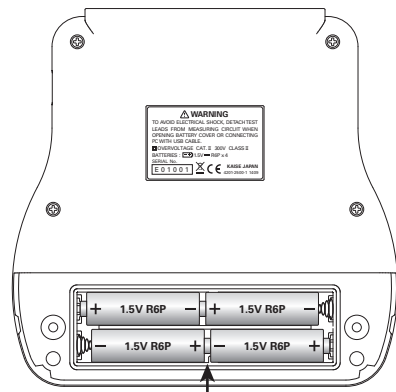

1.5V R6P Batteries - 4 pcs.

## 2. Calendar and Language Settings

- Calendar (date and time) : Set before using the instrument. See page 60 for details.
- Language : English or Japanese are selectable. Default setting is English. (See page 60 for details)

# PRIOR TO USE

## 3. Protection Film

- Front plate of the instrument is covered with protector film. Peel it off before use.

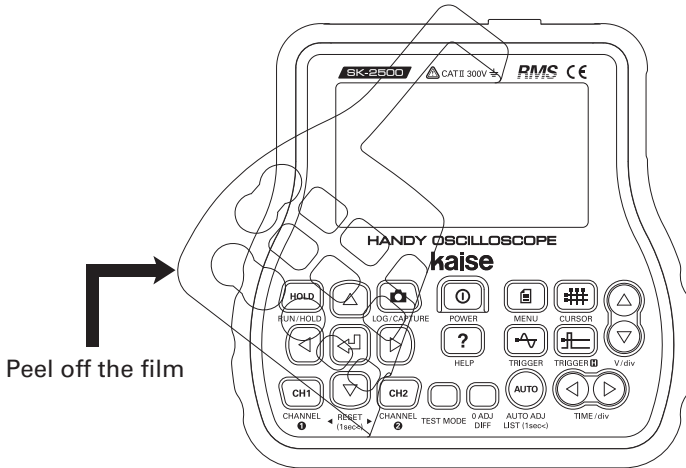

# GRAPH MODE



Read "SAFETY PRECAUTIONS" in pages 1 to 6 carefully before measurements. Strictly observe the warnings and cautions.

## 1. Screen Display

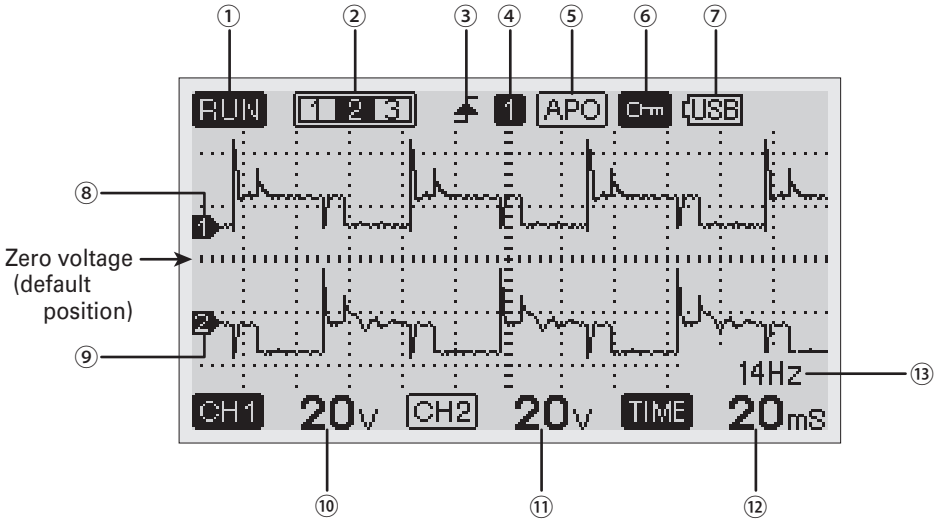

### ① RUN / HOLD symbol :

- RUN : Measurements are running.
- HOLD : Measurements are stopped, the screen is frozen. (HOLD Key lights up)



### ② Graph Display Area :

- Set the waveform area to display on the screen with : MENU→Graph Set Up→ Graph Display Area. (see page 51)
- : Left side of the waveform is displayed.
- : Center of the waveform is displayed.
- : Right side of the waveform is displayed



※Screen is not divided when the time axis is set to 50mS or more. The whole waveform is displayed on the screen with symbol.

## GRAPH MODE

### ③ Trigger Rising / Falling symbol :

- Set the trigger slope with : MENU→Trigger Set Up→Slope. (see page 52)
- Rising edge trigger ( symbol) :  
Triggering when the waveform is rising against trigger level.
- Falling edge trigger ( symbol) :  
Triggering when the waveform is falling against trigger level.

### ④ Triggering Channel :

- Set the channel to apply triggering with : MENU→Trigger Set Up→Channel. (see page 52)
-  : Triggering on the waveform of channel-1.
-  : Triggering on the waveform of channel-2.

### ⑤ Auto Power Off :



-  symbol lights up when auto power off is activated. Set with MENU→Auto Power Off. (default setting : OFF)
- When activating Auto Power Off : The instrument turns off automatically after a lapse of 30 minutes. (effective for battery operation only)

※ Press POWER Key twice restart from auto power off.

### ⑥ Lock symbol :

-  symbol lights up when data logging is activated (see page 48). All keys are locked except for LOG/CAPTURE Key.

### ⑦ Power indication :

-  : USB power supply.
-  : Battery warning. Replace the batteries with the procedure page 63.

### ⑧ Waveform for channel-1

### ⑨ Waveform for channel-2

### ⑩ Voltage/division (V/Div) value for channel-1

### ⑪ Voltage/division (V/Div) value for channel-2

### ⑫ Time/division (Time/Div) value (common with channels 1 and 2)

### ⑬ Frequency Measurement Value :

- Frequency value of the selecting channel.

# GRAPH MODE

## 2. Viewing Waveform (1-channel)

- ① Insert Red test lead plug into CH1 (+) input terminal. Insert Black test lead plug to COM terminal. (see drawings below)

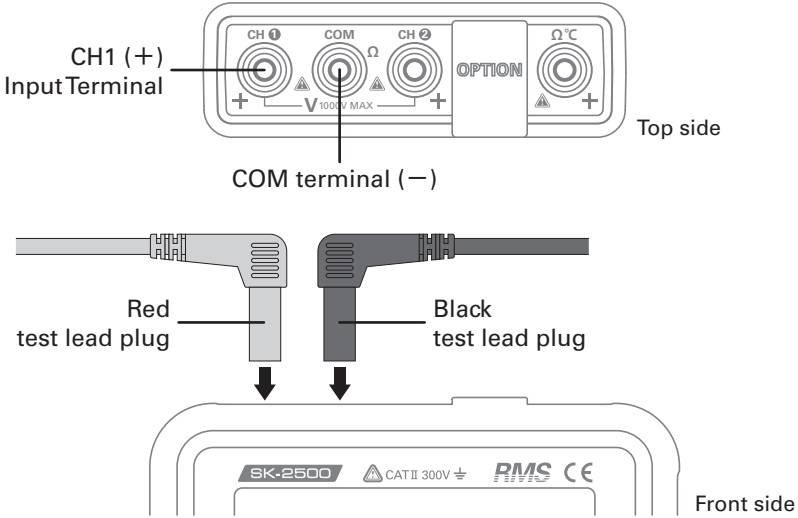

- ② Press POWER Key to turn on the instrument.
- ③ Contact test pins to the object to be measured.
- ④ Press AUTO ADJ (AUTO) Key. The waveform is optimized automatically. You can also use Car Maintenance List function in page 23 when needed.
- ⑤ Press V/div and TIME/div Keys to improve the waveform more visible.

Example of the waveform

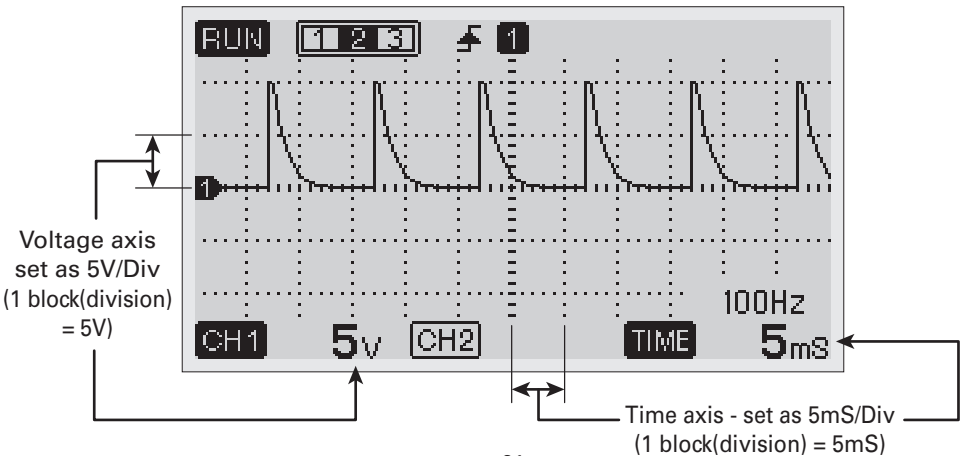

# GRAPH MODE

## 3. Automatic Waveform Adjustment

① Press AUTO ADJ (AUTO) Key. Voltage and time axes are optimized automatically.

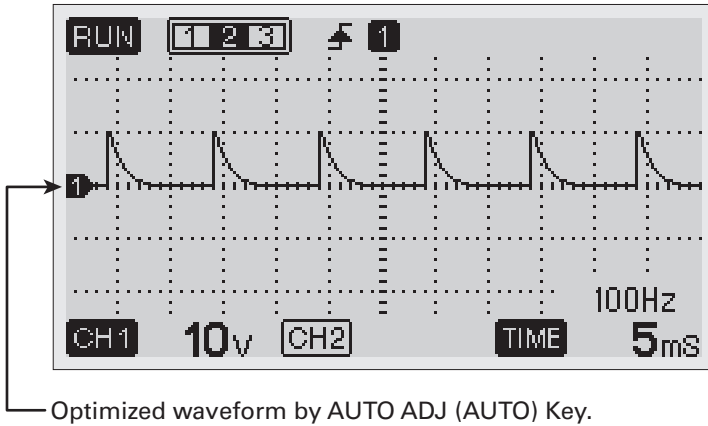

② Press V/div and TIME/div Keys to adjust the waveform manually. You can improve the waveform more visible.

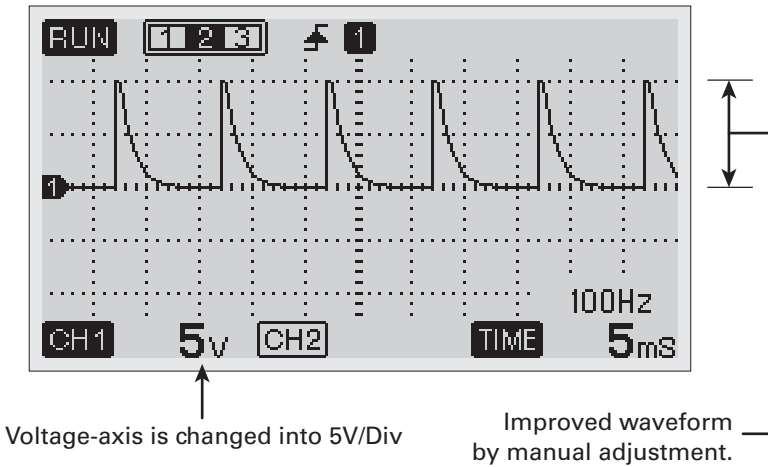



# GRAPH MODE

## 4. Car Maintenance List

Auto-setting function for the typical vehicle maintenances. Just selecting the sensor or signal to be measured, the instrument sets voltage and time axes, trigger level, trigger position, trigger settings, waveform display automatically.

※Green illumination lights up on AUTO Key while auto-setting of this function is activating. Press AUTO Key to release and to use normal auto-adjust function.

① Press and hold AUTO ADJ (AUTO) Key. Car Maintenance List is displayed on the screen. Select the item to be measured with ↑ ↓ Keys, then press ↵ (ENTER) Key.

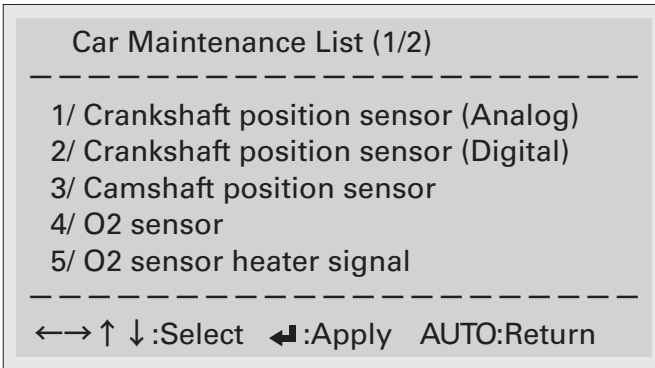

② The waveform optimized for the selected sensor or signal is displayed on the screen. Press V/div and TIME/div Keys to adjust the waveform manually. You can improve the waveform more visible.

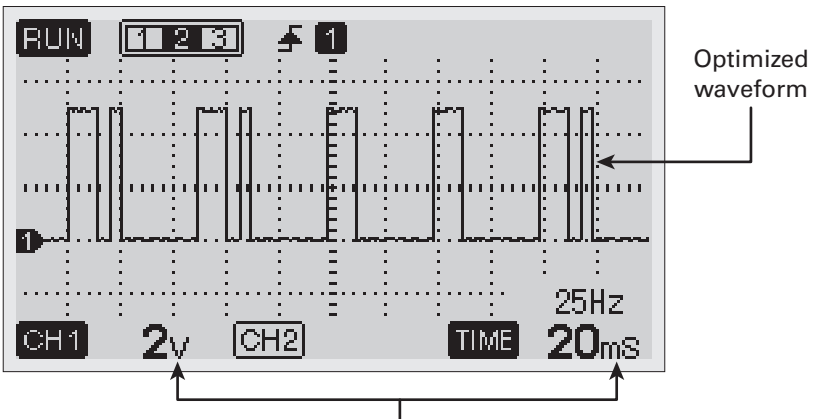

Automatically optimized voltage and time axes.

# GRAPH MODE

## 5. Viewing Waveform (2-channels)

You can observe 2-channels waveforms by using 100-57R Red Test Lead (option).

- ① Insert Red test lead plugs into CH1 (+) and CH2 (+) input terminals (CH2 for optional red test lead). Insert Black test lead plug to COM terminal. (see drawings below)  
※COM terminal is common with channels 1 and 2 (the same grounding is used).

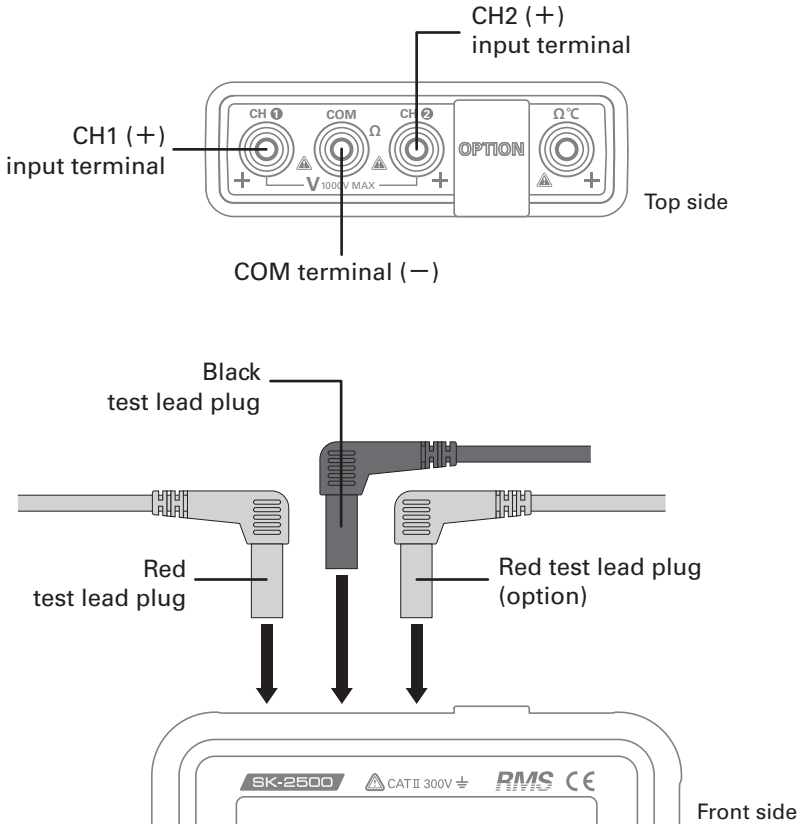

- ② Press POWER Key to turn on the instrument.
- ③ Contact test pins to the object to be measured.

# GRAPH MODE

④ Press AUTO ADJ (AUTO) Key. The waveform is optimized automatically.

You can also use Car Maintenance List function in page 23 when needed.

⑤ Press V/div and TIME/div Keys to improve the waveform more visible.

- Press CH1 Key to select and adjust the channel-1.

(CH1 Key lights up. CH1 symbol on the screen is highlighted as **CH1**.)

- Press CH2 Key to select and adjust the channel-2.

(CH2 Key lights up. CH2 symbol on the screen is highlighted as **CH2**.)

※ When using Auto-Adjustment or Car Maintenance List functions, select the channel that wants to set the time axis.

※ When the time axis is set  $10\mu\text{S}$  to  $500\text{nS}$ , only a single waveform for the selected channel is displayed on the screen.

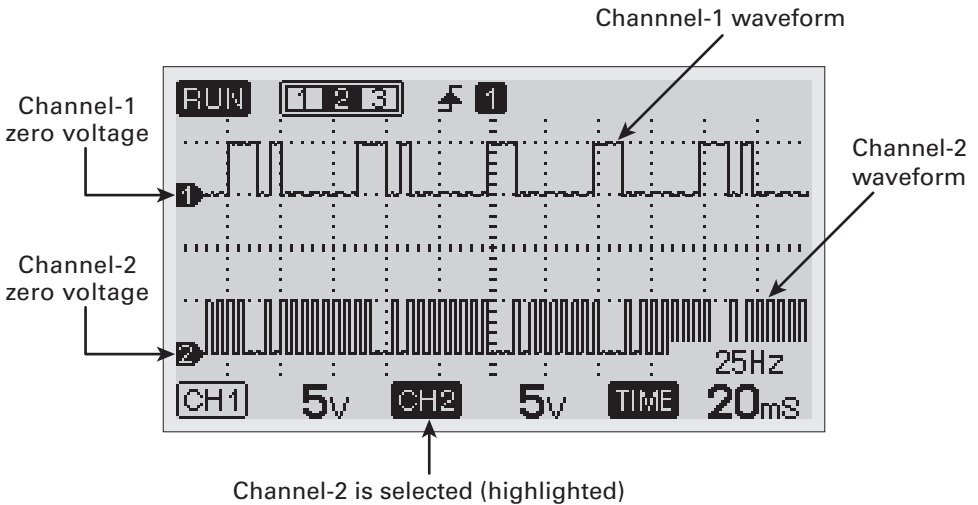

※ In the above example, the waveforms are moved to the visible area. (see page 27 for moving the waveform)

※ If zero voltages of channel 1 and 2 are overlapped, the zero position of the selected channel is displayed.

# GRAPH MODE

## 6. Holding (HOLD) / Running (RUN) the Waveform

① Press RUN/HOLD Key to stop measurement and freeze the screen.

(**HOLD**) lights up on the upper left corner of the screen. HOLD Key lights up in red.)

※ You can move the waveform of the selected channel with arrow (←/→ ↑ ↓) Keys.

※ To reset the moved zero voltage into the default position, press and hold the selecting CH Key.

② Press RUN/HOLD Key again to restart the measurement.

(**RUN**) lights up on the upper left corner of the screen. HOLD Key lights down.)

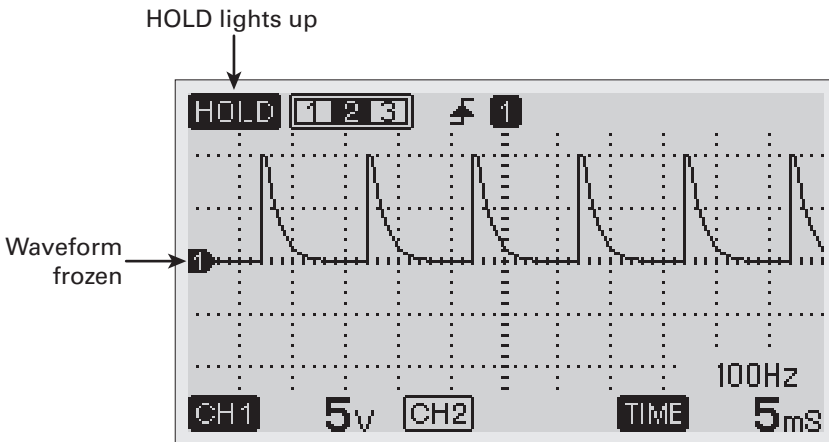

Following operations can be used during HOLD function.

- Adjusting voltage and time axes
- Changing the channels
- Capturing the screen (see page 49)
- Cursor function (see page 32)
- Moving the waveform positions (see page 27)

# GRAPH MODE

## 7. Moving the Waveform

Use  $\uparrow$   $\downarrow$  Keys to move the waveform of the selected channel to the desired position.

※Press and hold the selecting CH Key to reset to the default position.

Example 1 : Move down and enlarge the waveform.

- ①Press  $\downarrow$  Key and move the waveform to downward.
- ②Change voltage axis to enlarge the height of the waveform.

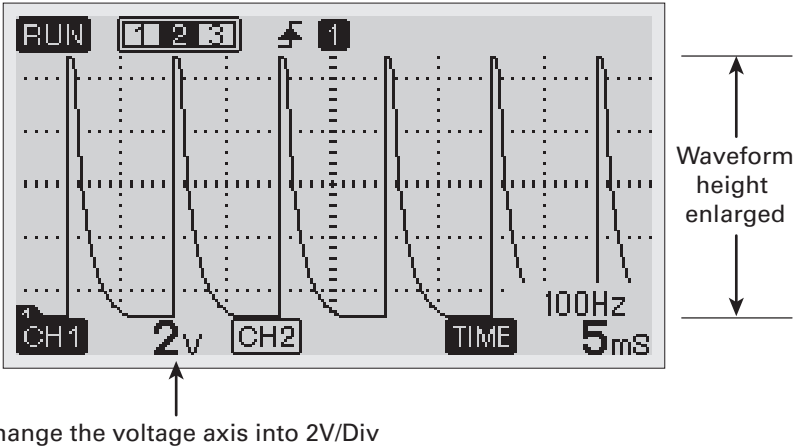

Example 2 : Move the waveforms of channel 1 and 2 to be more visible.

- ①Select channel-1 by pressing CH1 Key. Move the waveform with  $\uparrow$   $\downarrow$  Keys.
- ②Select channel-2 by pressing CH2 Key. Move the waveform with  $\uparrow$   $\downarrow$  Keys.

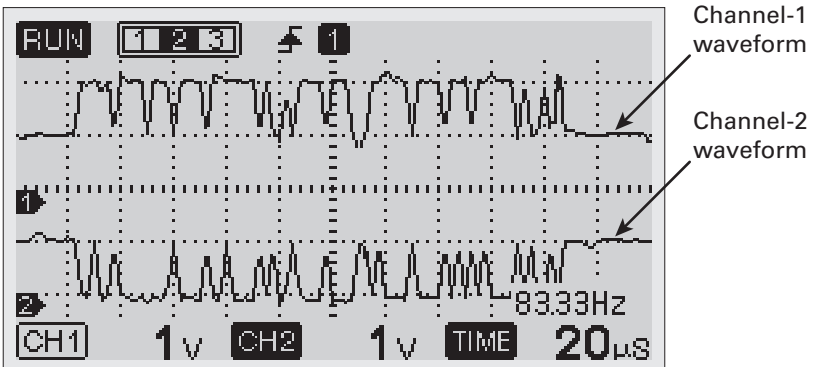

# GRAPH MODE

## 8. Triggering on Waveform

【What the “Trigger” is?】

Triggering is the function to make the point when to begin displaying the waveform. Setting this allows you to stabilize the repeating waveforms and to capture the single-shot waveforms. The trigger makes repeating waveforms appear static on the screen.

- ① Press MENU Key to open MENU screen. Go down the menu with ↓ Key and select Trigger Set Up. Press ← (ENTER) Key.
  - ② Set trigger ON/OFF, trigger slope (Rise or Fall), and the channel to be triggered (CH1 or CH2). See page 52 for details.
  - ③ Close MENU screen and back to Graph display screen.
  - ④ Display the waveform of the channel to be triggered with the measurement running (RUN). Press TRIGGER Key. Trigger level bar on voltage axis, trigger position bar on time axis, and trigger level voltage are displayed on the screen.
- ※ Trigger bars are disappeared if no key is pressed for 10 seconds.

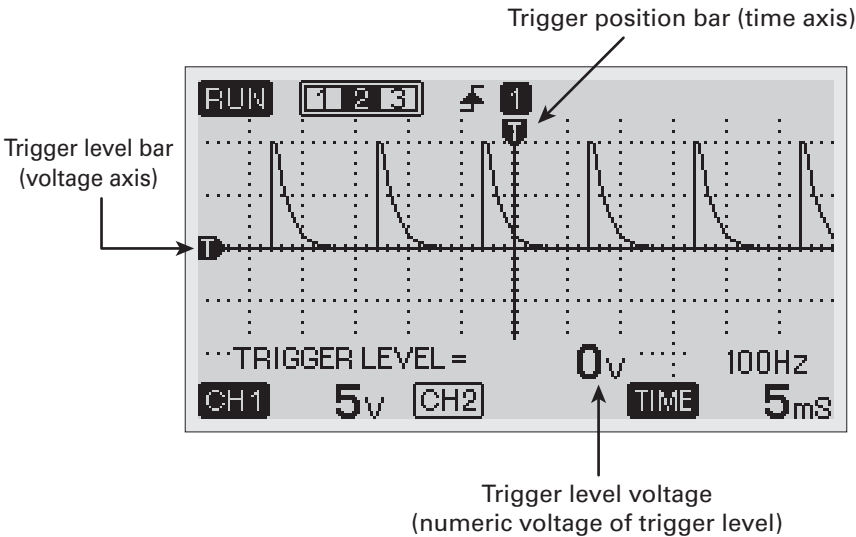

# GRAPH MODE

## ⑤ Set the trigger level.

Press  $\uparrow$   $\downarrow$  Keys to move trigger level bar on voltage axis. Numeric voltage of trigger level is displayed on the bottom of the screen. The cross-point between trigger level bar and trigger position bar is called as Trigger Point.

In the drawing below, triggering is activated on the rising edge of 5V input. Displayed waveform seems static.

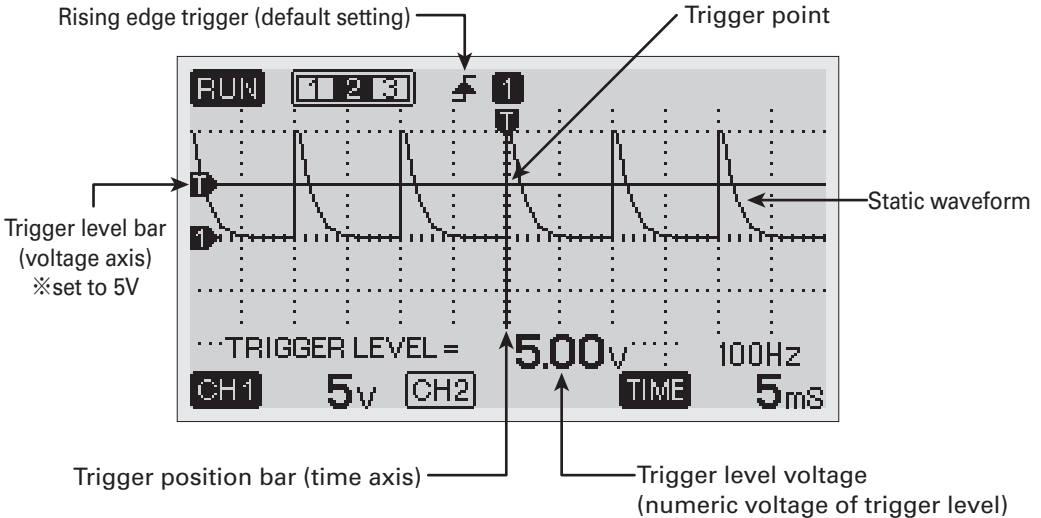

## ③ Press $\leftarrow$ / $\rightarrow$ Key to move trigger position bar on time axis.

You can change trigger point accordingly.

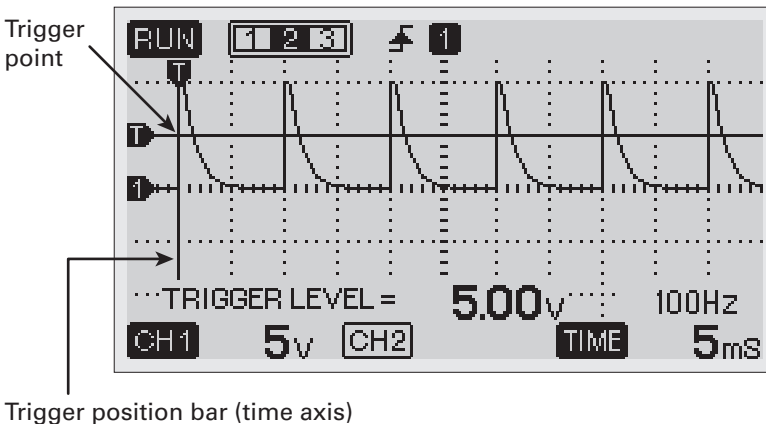

# GRAPH MODE

## 9. Trigger Hold

This function can freeze the waveform that reaches the trigger level.

Trigger hold is effective to catch the single-shot high voltage like the example below.

- ① Set the trigger level with the procedures in "8. Triggering the Waveform". (Set to 10V in the example below)
- ② Press TRIGGER-H Key. "TRIGGER HOLD SET" is displayed on the upper right corner of the screen. In the example below, the displayed waveform remain moving because the peak voltage is around 5V which does not reaches the trigger level.

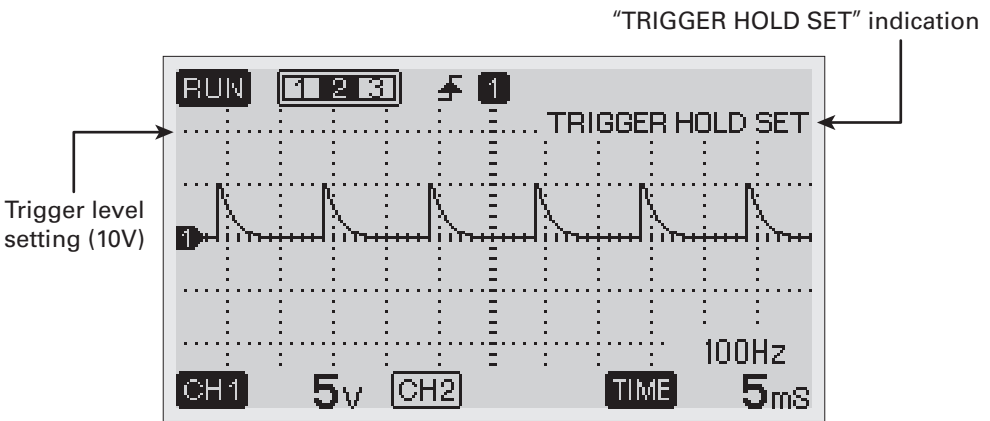

- ③ Waveform is frozen when detecting the single-shot voltage that reaches trigger level. (HOLD lights up. RUN/HOLD key lights up in red)

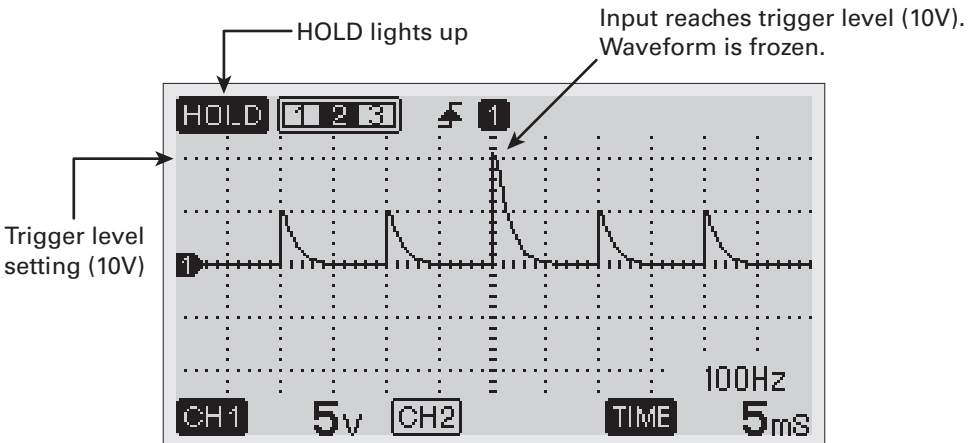



## GRAPH MODE

### ● Adjusting trigger level during trigger hold function

You can change trigger level while activating the trigger hold function.

Example : Change the trigger level from 10V to 4V

- ① Press TRIGGER Key while activating the trigger hold function. Trigger level bars are displayed on the screen.
- ② Press ↓ Key and move down the trigger level bar to 4V. The waveform is frozen as the peak voltage exceeds the trigger point at 4V.

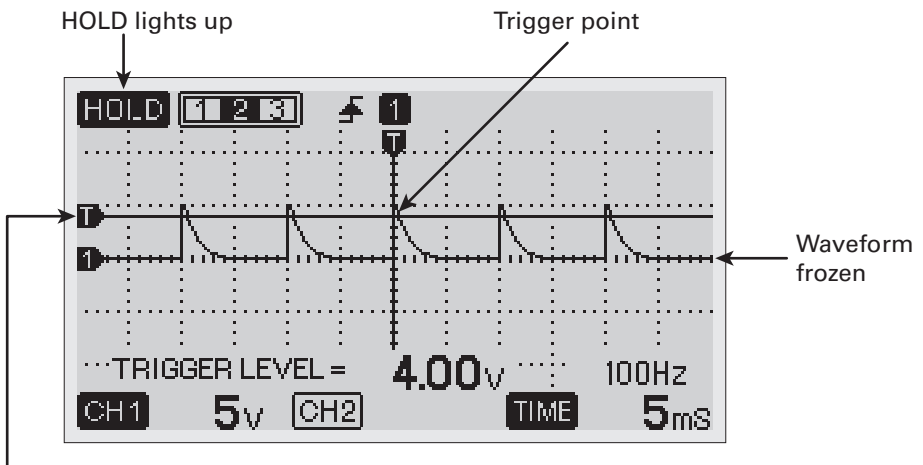

Move down the trigger level bar from 10V to 4V.

# GRAPH MODE

## 10. Using Cursors

Cursor function allows you to make precise digital measurements on waveforms. The screen shows the numeric values such as differences between the two cursors.

※To hide the cursors, press and hold CURSOR Key.

### ●Using A—B cursors (Horizontal cursors : for voltage readings)

①Press CURSOR Key. A and B cursors are displayed on the screen with the numeric readings as below.

**A** : Voltage at A-cursor

**B** : Voltage at B-cursor

**A-B** : Voltage difference between A and B cursors

A-cursor (flashing)

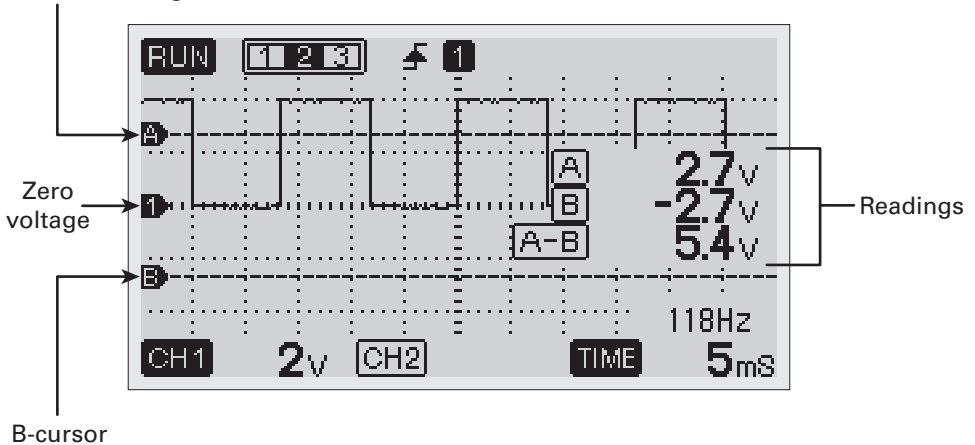

## GRAPH MODE

- ② Press  $\uparrow \downarrow$  Keys to move the A-cursor (flashing) to the desired position. In the example below, A-cursor is set to the peak voltage line.
- ③ Press  $\leftarrow$  (ENTER) Key to flash the B-cursor. Press  $\uparrow \downarrow$  Keys to move the cursor. In the example below, B-cursor is set to the zero voltage line.
- ④ The screen shows the voltage difference between A and B cursors and the voltages of each cursor.

Set A-cursor to the peak voltage line.

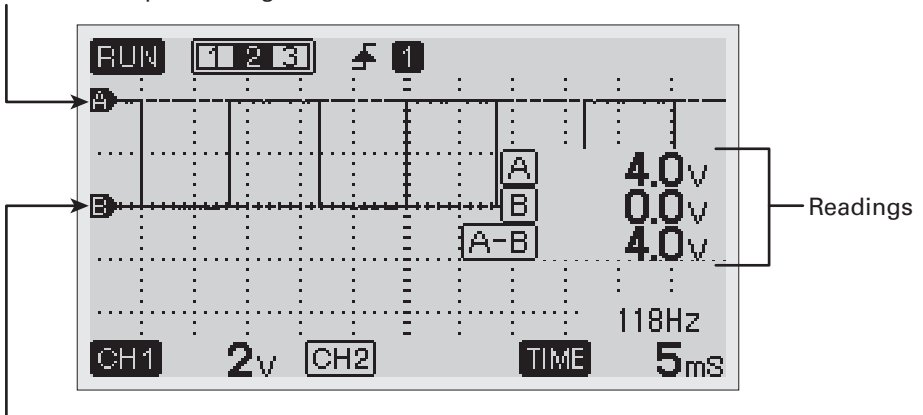

Set B-cursor to zero voltage line.

Press CURSOR Key to move to the C—D cursor screen in the next page.

# GRAPH MODE

## ● Using C—D cursors (Vertical cursors : for time and frequency)

- ① Press CURSOR Key in A—B cursor screen to enter C—D cursor screen. C and D cursors are displayed on the screen with the numeric readings as below.

**C-D** : Time and frequency between C and D cursors

C-cursor (flashing)

D-cursor

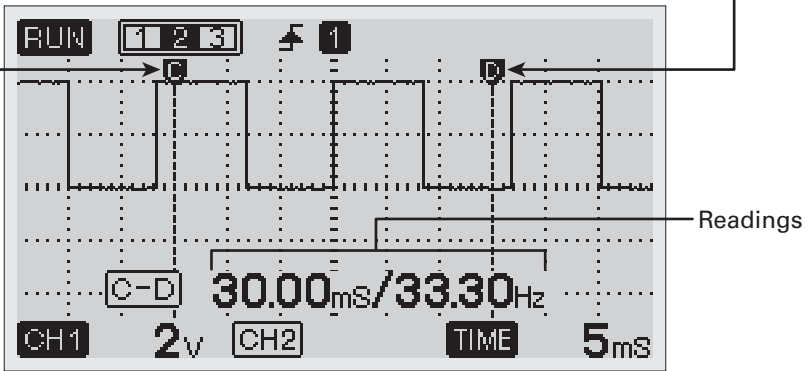

- ② Press ←/→ Keys to move the C-cursor (flashing) to the desired position.
- ③ Press ↵ (ENTER) Key to flash the D-cursor. Press ←/→ Keys to move the cursor. In the example below, C and D cursors are set on the one cycle of the waveform.
- ④ The screen shows the time and frequency between C and D cursors.

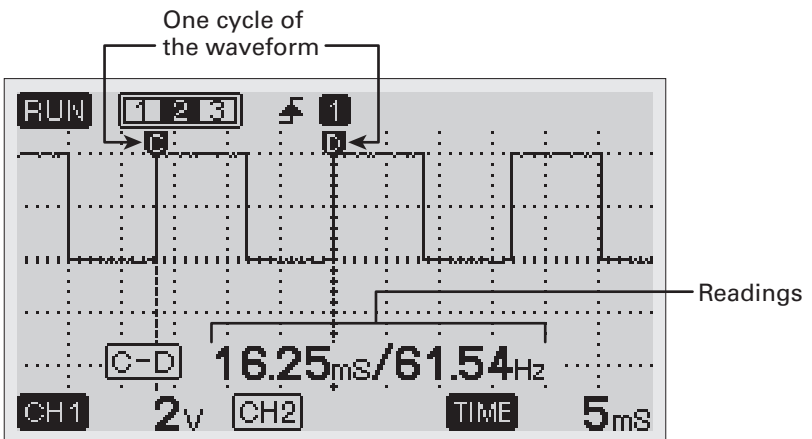

Press CURSOR Key to move to RPM Measurement screen using C—D cursors.

## GRAPH MODE

### ●RPM Measurement using C—D cursors

You can measure RPM of the vehicle engine using C—D cursors.

Optional RPM Sensors are required for measurement. Use either 653 (for direct ignition) or 650 (for high tension cord) depending on the sensor to be measured.

Measuring 4-stroke engine : Press CURSOR Key ONCE in C—D cursor screen.

Measuring 2-stroke engine : Press CURSOR Key TWICE in C—D cursor screen.

- ① Insert the plugs of RPM sensor to input terminals. Insert Red plug into CH1 (+) input terminal, and insert Black plug to COM terminal.
- ② Put the RPM sensors as the drawings below.

#### ● For Direct Ignition engine

Fix the sensor on direct ignition coil with the provided velcro tape.

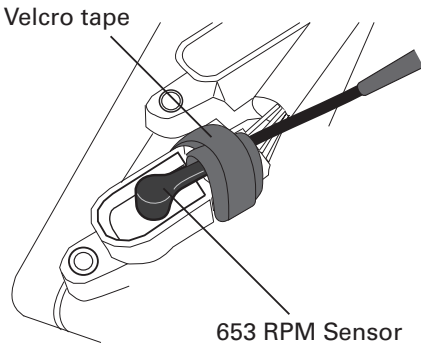

#### ● For the engine with High Tension Cord

Clamp the high tension cord with the RPM sensor.

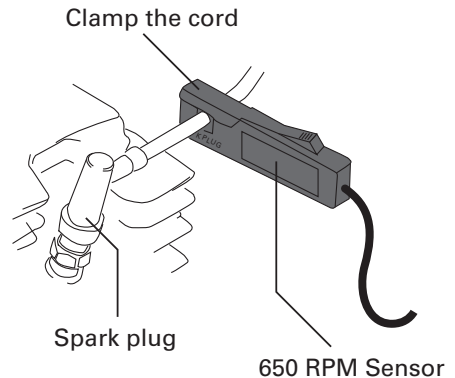

## GRAPH MODE

- ③ Adjust voltage and time axes and trigger level to show the visible waveform.
- ④ Press ←/→ Keys and move C and D cursors on the one cycle of the waveform. The RPM of the measuring engine is displayed on the screen. The example below is for 4-stroke engine.

**C-D** : Time and engine RPM between C and D cursors

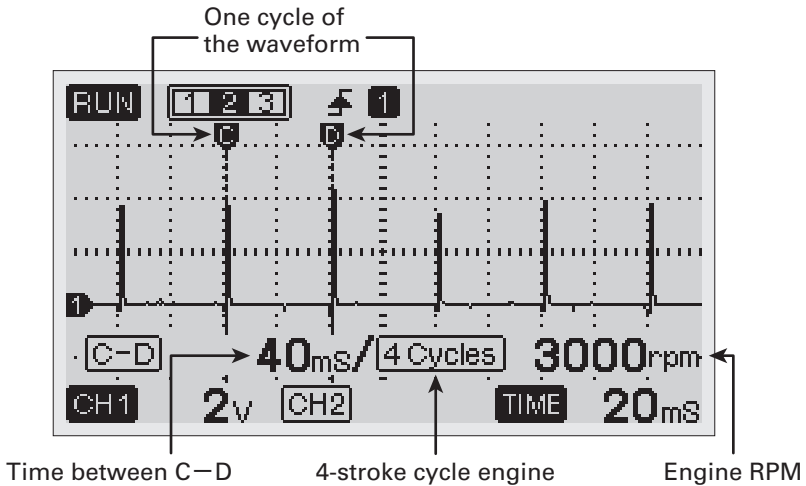

- ⑤ To measure 2-stroke engine, press CURSOR Key in the above screen.
- ※ For the vehicle with 4-stroke simultaneous ignition engine, measure as 2-stroke engine.

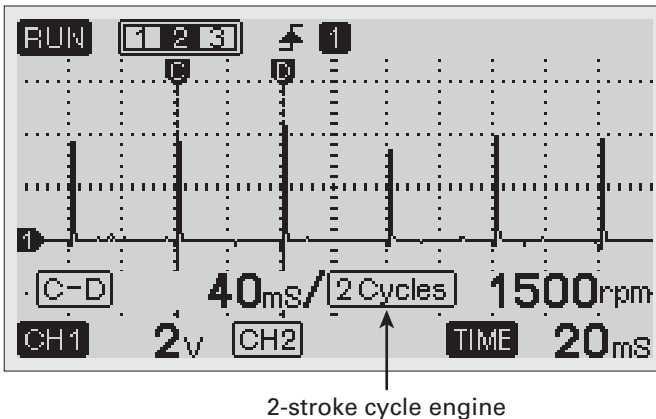

Press CURSOR Key to move to Ratio and Duty Cycle measurements using C-D-E cursors.

## GRAPH MODE

### ● Ratio and Duty Cycle Measurements using C—D—E cursors

- ① Press CURSOR Key in 2-stroke RPM measurement screen. C, D, E cursors are displayed.
- ② Press  $\leftarrow/\rightarrow$  Keys and put the E cursor between C and D cursors. The screen shows the following ratios.

$\boxed{C-E}$  : Ratio of C—E among C—D

$\boxed{D-E}$  : Ratio of E—D among C—D

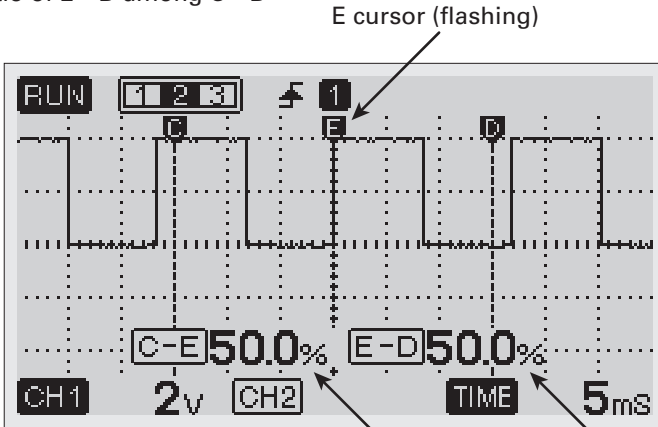

Ratio of C—E among C—D

Ratio of E—D among C—D

- ③ Making Duty Cycle measurement. Press  $\leftarrow/\rightarrow$  Keys and move the each cursor to the positions shown in the example below. Press  $\blacktriangleleft$  (ENTER) Key to change the cursor to be moved (flashing). Duty cycle of the waveform is displayed on the screen.

※ If E-cursor goes outside of C—D cursors, the readings should be “— — — %”.

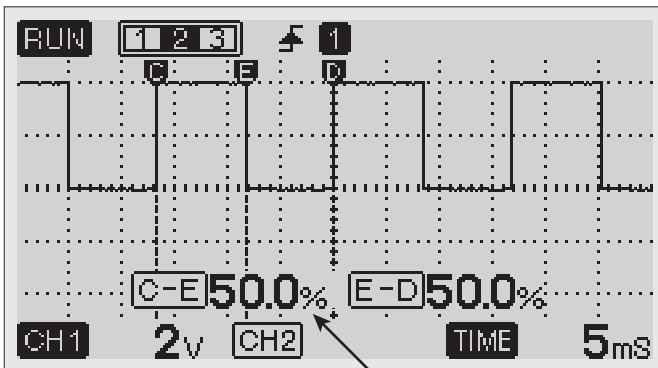

Duty cycle of the waveform

Cursor function is closed when pressing CURSOR Key in the above screen.

# GRAPH MODE

## 11. Using Clamp Adapter (Option)

You can make Current Measurement by using the optional 660 AC/DC Clamp Adapter. Following is the example of the dual vehicle waveform measurements, for battery voltage and alternator charging current.

- ① Insert Red test lead plug into CH1 (+) input terminal. Insert Black test lead plug to COM terminal.
  - ② Insert the plugs of Clamp Adapter to the terminals of channel-2. Insert Red plug into CH2 (+) input terminal, and insert Black plug to COM(SUB) terminal.
- ※ See the drawings below.

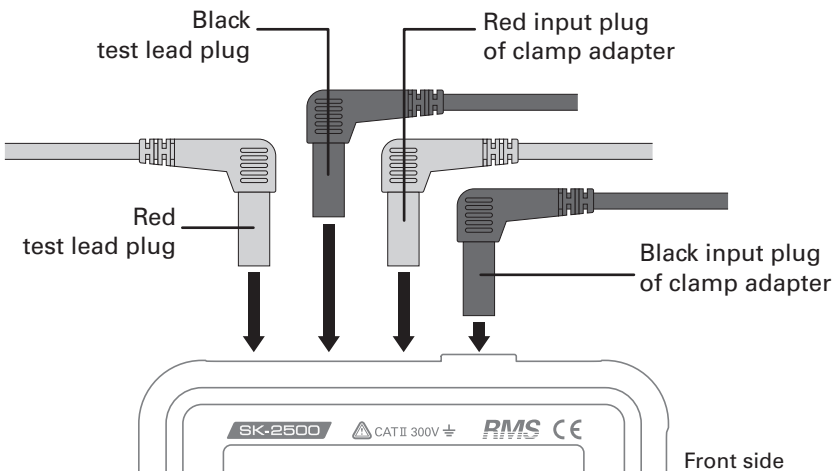
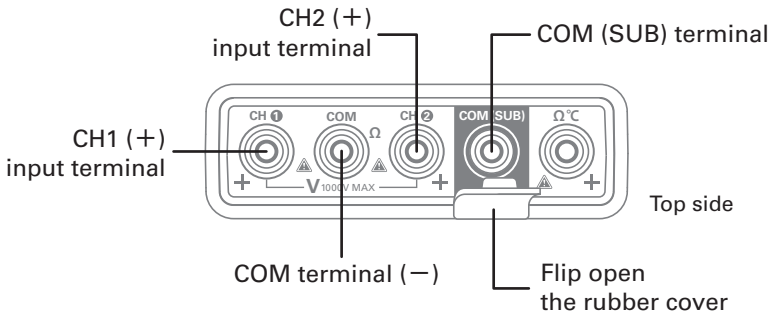



## GRAPH MODE

- ③ Press POWER Key to turn on the instrument.
- ④ Contact Red test pin to plus (+) battery terminal. Contact Black test pin to minus (-) terminal.
- ⑤ Press AUTO ADJ (AUTO) Key. Battery voltage waveform is displayed on the screen as CH1.
- ⑥ Move up the CH1 waveform to make the space for CH2 waveform.
- ⑦ Set the measurement range of 660 AC/DC Clamp Adapter into 40A.
- ⑧ Clamp B-terminal of the alternator with 660 AC/DC Clamp Adapter.
- ⑨ Start the engine of the vehicle.
- ⑩ Press CH2, the press AUTO ADJ (AUTO) Key. Alternator charging current waveform is displayed on the screen as CH2.
- ⑪ Move the waveform of CH2 to visible position.

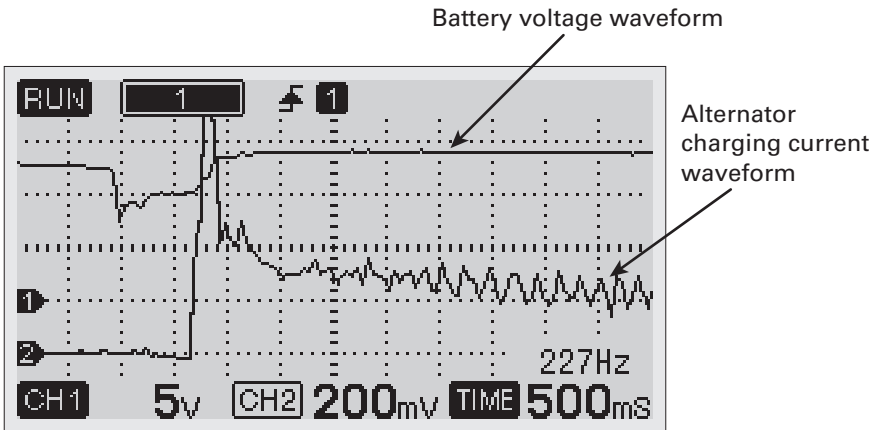

# DMM MODE

Making Multimeter Measurements with numeric readings on the screen.

Press TEST MODE Key in Graph mode to enter DMM mode.

Measurement items are changed as below by pressing TEST MODE Key.

Graph mode → DMM mode (DC Voltage → Resistance → Continuity → AC Voltage →

Frequency → Duty Cycle → Pulse Width → Temperature → DC Voltage)

※Press and hold TEST MODE Key to go back to Graph mode.

## 1. Screen Display

### 1-channel measurement display

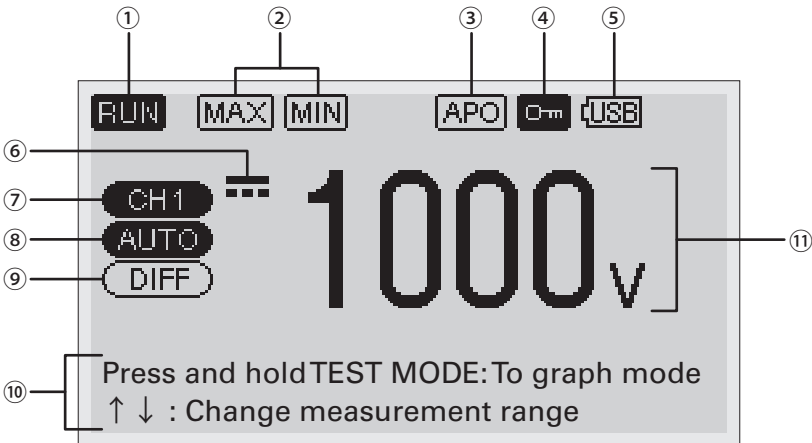

### 2-channels measurement display

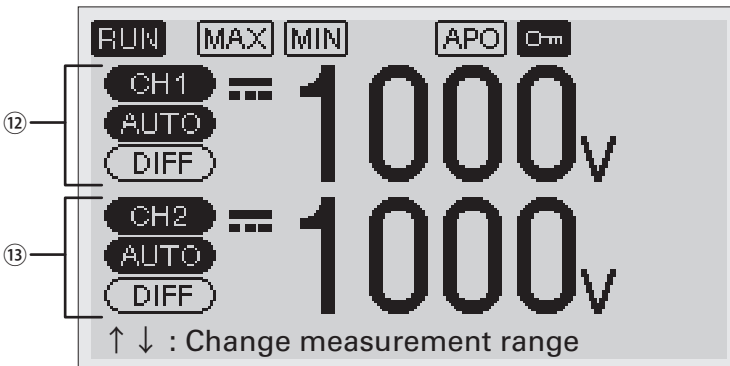

## DMM MODE

### ① RUN / HOLD symbol :

- RUN : Measurements are running.
- HOLD : Measurements are stopped, the screen is frozen. (HOLD Key lights up)

### ② MAX / MIN symbol :

- MAX/MIN measurement is activating. (see page 42)

### ③ Auto Power Off (see page 20)

### ④ Lock symbol (see page 20)

### ⑤ Power indication (see page 20)

### ⑥ DC ( — ) / AC ( ~ ) symbol

### ⑦ Selected channel (CH1 / CH2)

### ⑧ Measurement range (AUTO or manual measurement ranges)

### ⑨ DIFF / ZERO symbol :

- Difference measurement (  ) :

Press 0 ADJ/DIFF Key in AC/DC Voltages ( — / ~ ) and Temperature (°C) measurements. Set the readings when pressed the key as criteria, and show the difference value on the screen. Press the key again to stop.

- Zero adjustment (  ) :

Press 0 ADJ/DIFF Key in Resistance (Ω) measurement. Zero adjustment is activated.

### ⑩ Operation guide

### ⑪ Measurement readings

### ⑫ Channel-1 settings and reading (when selecting CH1, highlighted as )

### ⑬ Channel-2 settings and reading (when selecting CH2, highlighted as )

# DMM MODE

## 2. DC Voltage Measurement (— V)



### WARNING

Read "SAFETY PRECAUTIONS" in pages 1 to 6 carefully before measurements. Strictly observe the warnings and cautions.

- ① Press TEST MODE Key in Graph mode. Enter DC Voltage measurement mode.
- ② Insert Red test lead plug into CH1 (+) input terminal. Insert Black test lead plug to COM terminal.
  - ※ For 2-channels measurement, insert another Red test lead plug to CH2 (+) input terminal. (optional test lead required)
- ③ Contact test pins to the object to be measured.
- ④ See the readings on screen.
  - Press  $\uparrow$   $\downarrow$  Keys to change measurement ranges as below.  
Auto range  $\rightarrow$  200mV  $\rightarrow$  2V  $\rightarrow$  20V  $\rightarrow$  200V  $\rightarrow$  1000V  $\rightarrow$  200mV (when pressing  $\uparrow$  Key)
    - ※ Press AUTO Key to return to the auto range measurement.

### ● MAX/MIN Measurement

Enable to measure the maximum / minimum values during the measurement.

- Press  $\leftarrow$  (ENTER) Key while measurements are running (RUN).  
MAX/MIN measurement is activated with MAX MIN symbols on the screen.
  - Press  $\leftarrow$  (ENTER) Key again to display the maximum value. (MAX lights up)
  - Press  $\leftarrow$  (ENTER) Key again to display the minimum value. (MIN lights up)
  - Press and hold  $\leftarrow$  (ENTER) Key to stop MAX/MIN measurement.
- ※ Measurement range is fixed during MAX/MIN measurement.

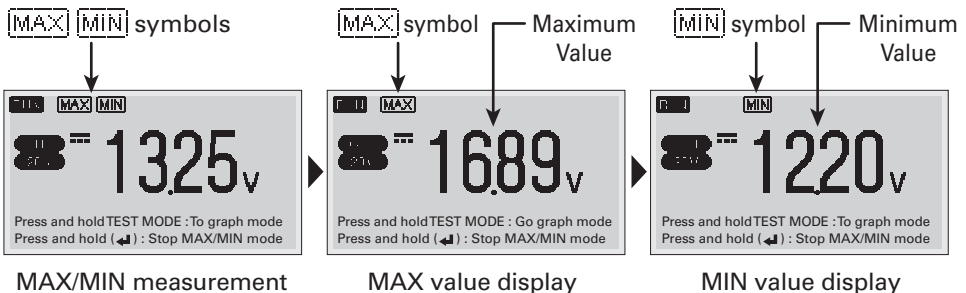

# DMM MODE

## ● Difference Measurement

- Press 0 ADJ/DIFF Key while the measurements are running (RUN). The readings when pressed the key is set as criteria, and show the difference value on the screen. (**DIFF** lights up)
  - Press 0 ADJ/DIFF Key again to stop Difference measurement (**DIFF** disappears).
- ※ Measurement range is fixed during Difference measurement.

## ● Display Hold Function

- Screen is frozen by pressing RUN/HOLD Key while the measurements are running (**HOLD** lights up).
- Press RUN/HOLD Key again to release display hold (**HOLD** lights up).

## ● 2-Channels Measurement

- Press CH2 Key to make 2-channels measurement. The highlighted channel is operatable.

## 3. Resistance Measurement ( $\Omega$ )



Read "SAFETY PRECAUTIONS" in pages 1 to 6 carefully before measurements. Strictly observe the warnings and cautions.

- ① Press TEST MODE Key twice in Graph mode. Enter Resistance measurement mode.
- ② Insert Red test lead plug into  $\Omega^{\circ}\text{C}$  (+) input terminal. Insert Black test lead plug to COM terminal. (see drawings below)

※ 1-channel measurement only.

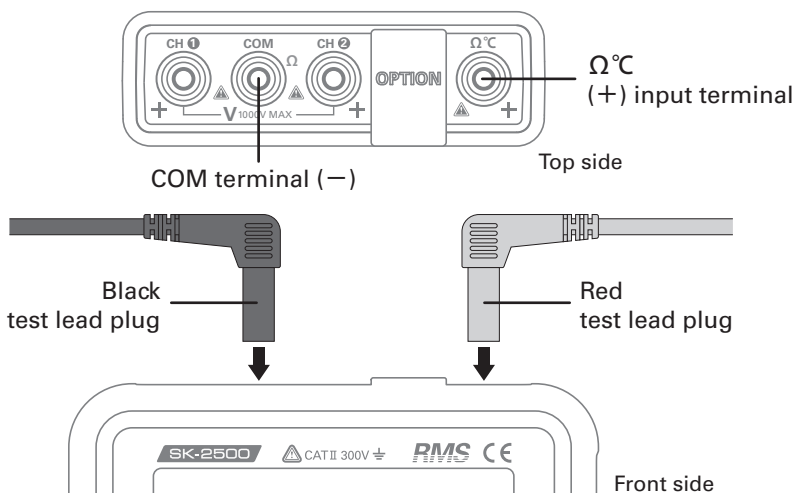

- ③ Make zero adjustment. Short-circuit the test lead pins and press 0 ADJ/DIFF Key. (**ZERO** lights up)

## DMM MODE

- ④ Contact the test pins to the object to be measured.
- ⑤ See the readings on screen.
  - Press  $\uparrow \downarrow$  Keys to change measurement ranges as below.  
Auto range  $\rightarrow 2k\Omega \rightarrow 20k\Omega \rightarrow 2k\Omega$  (when pressing  $\uparrow$  Key)
    - ※ Press AUTO Key to return to the auto range measurement.

### ● Zero Adjustment Function

- Press 0 ADJ/DIFF Key while the measurements are running (RUN). The readings when pressed the key is adjusted to  $0\Omega$  (**ZERO** lights up).
  - Press 0 ADJ/DIFF Key again to release Zero Adjustment (**ZERO** disappears).
- ※ Measurement range is fixed when Zero Adjustment is activated. (incl. AUTO range).

### ● Display Hold Function

- Screen is frozen by pressing RUN/HOLD Key while the measurements are running (**HOLD** lights up).
- Press RUN/HOLD Key again to release display hold (**RUN** lights up).

## 4. Continuity Test ( $\cdot \parallel$ )



### WARNING

Read "SAFETY PRECAUTIONS" in pages 1 to 6 carefully before measurements. Strictly observe the warnings and cautions.

- ① Press TEST MODE Key three times in Graph mode. Enter Continuity Test mode.
- ② Insert Red test lead plug into  $\Omega^{\circ}\text{C}$  (+) input terminal. Insert Black test lead plug to COM terminal.
  - ※ 1-channel measurement only.
- ③ Contact the test pins to both ends of the circuit to be tested.
- ④ Continuity buzzer sounds when the circuit resistance is  $50\Omega$  or less.

## 5. AC Voltage Measurement ( $\sim V$ )



### WARNING

Read "SAFETY PRECAUTIONS" in pages 1 to 6 carefully before measurements. Strictly observe the warnings and cautions.

- ① Press TEST MODE Key four times in Graph mode. Enter AC Voltage measurement mode.
- ② Insert Red test lead plug into CH1 (+) input terminal. Insert Black test lead plug to COM terminal.
  - ※ For 2-channels measurement, insert another Red test lead plug to CH2 (+) input terminal. (optional test lead required)
  - ※ Dual display for CH1 and CH2 is not available in AC Voltage measurement.



## DMM MODE

- ③ Contact the test pins to the object to be measured.
- ④ See the readings on screen.
  - Press  $\uparrow$   $\downarrow$  Keys to change measurement ranges as below.  
Auto range  $\rightarrow$  2V  $\rightarrow$  20V  $\rightarrow$  200V  $\rightarrow$  600V  $\rightarrow$  2V (when pressing  $\uparrow$  Key)
    - ※ Press AUTO Key to return to the auto range measurement.
  - Press  $\leftarrow$  (ENTER) Key : MAX/MIN measurement is activated. (see page 42)
  - Press 0 ADJ/DIFF Key : Difference measurement is activated. (see page 43)
  - Press RUN/HOLD Key : The screen is frozen. (see page 43)

## 6. Frequency Measurement (Hz)



Read "SAFETY PRECAUTIONS" in pages 1 to 6 carefully before measurements. Strictly observe the warnings and cautions.

- ① Press TEST MODE Key five times in Graph mode. Enter Frequency measurement mode.
  - ② Insert Red test lead plug into CH1 (+) input terminal. Insert Black test lead plug to COM terminal.
    - ※ For 2-channels measurement, insert another Red test lead plug to CH2 (+) input terminal. (optional test lead required)
    - ※ Dual display for CH1 and CH2 is not available in Frequency measurement.
  - ③ Contact the test pins to the object to be measured.
  - ④ See the readings on screen.
    - Range select is not available (auto range only).
- **Display Hold Function**
- Screen is frozen by pressing RUN/HOLD Key while the measurements are running (  lights up).
  - Press RUN/HOLD Key again to release display hold (  lights up).

## DMM MODE

### 7. Duty Cycle Measurement (%)





#### WARNING

Read "SAFETY PRECAUTIONS" in pages 1 to 6 carefully before measurements. Strictly observe the warnings and cautions.

- ① Press TEST MODE Key six times in Graph mode. Enter Duty Cycle measurement mode.
- ② Insert Red test lead plug into CH1 (+) input terminal. Insert Black test lead plug into COM terminal.
  - ※ For 2-channels measurement, insert another Red test lead plug to CH2 (+) input terminal. (optional test lead required)
  - ※ Dual display for CH1 and CH2 is not available in Duty Cycle measurement.
- ③ Contact the test pins to the object to be measured.
- ④ See the readings on screen.

#### ● Display Hold Function

- Screen is frozen by pressing RUN/HOLD Key while the measurements are running (  lights up).
- Press RUN/HOLD Key again to release display hold (  lights up).

### 8. Pulse Width Measurement (S)





#### WARNING

Read "SAFETY PRECAUTIONS" in pages 1 to 6 carefully before measurements. Strictly observe the warnings and cautions.

- ① Press TEST MODE Key seven times in Graph mode. Enter Pulse Width measurement mode.
- ② Insert Red test lead plug into CH1 (+) input terminal. Insert Black test lead plug into COM terminal.
  - ※ For 2-channels measurement, insert another Red test lead plug to CH2 (+) input terminal. (optional test lead required)
  - ※ Dual display for CH1 and CH2 is not available in Pulse Width measurement.
- ③ Contact the test pins to the object to be measured.
- ④ See the readings on screen.
  - Range select is not available (auto range only).

#### ● Display Hold Function

- Screen is frozen by pressing RUN/HOLD Key while the measurements are running (  lights up).
- Press RUN/HOLD Key again to release display hold (  lights up).



# DMM MODE

## 9. Temperature Measurement (°C)



### WARNING

Read "SAFETY PRECAUTIONS" in pages 1 to 6 carefully before measurements. Strictly observe the warnings and cautions.

- ① Press TEST MODE Key eight times in Graph mode. Enter Temperature measurement mode.
  - ② Use the optional temperature probe. Insert (+) plug into  $\Omega^{\circ}\text{C}$  (+) input terminal. Insert (-) plug to COM (SUB) terminal. (see drawings below)
- ※ 1-channel measurement only.

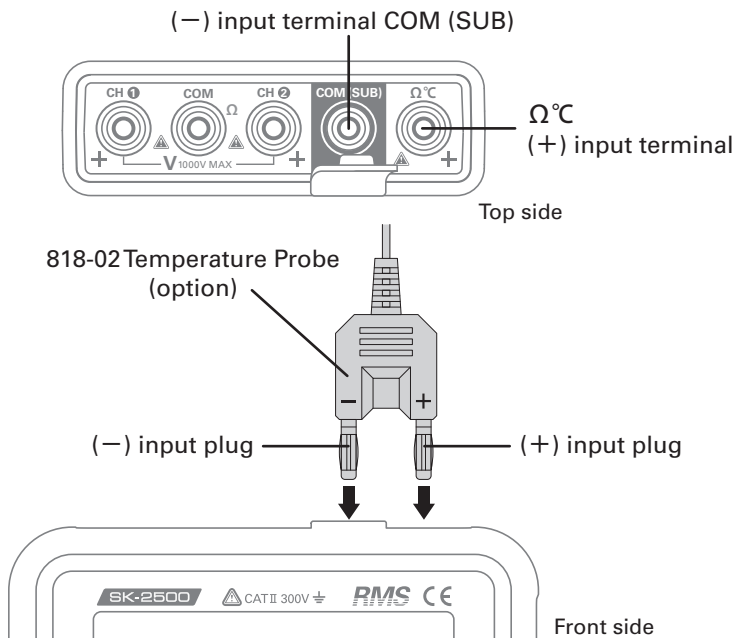

- ③ Contact the temperature sensor to the object to be measured.
- ④ See the readings on screen.
  - Press  $\blacktriangleleft$  (ENTER) Key : MAX/MIN measurement is activated. (see page 42)
  - Press 0 ADJ/DIFF Key : Difference measurement is activated. (see page 43)
  - Press RUN/HOLD Key : The screen is frozen. (see page 43)

# DATA LOGGING / CAPTURE

## 1. Data Logger

Data logger function is available for DC/AC Voltage measurement in both Graph and DMM modes. Logged data is saved in the instruments as CSV-format. You can move the saved data to PC to make data processing in spreadsheet software (see page 61).

※For details of data processing, see the manuals of your spreadsheet software.

- ① Display the waveform (Graph mode) or numeric data (DC/AC voltage in DMM mode) on the screen with the measurements running (RUN).
- ② Press LOG/CAPTURE Key.
- ③ LCD shows the screen like below. Select "Yes", and press **↵** (ENTER) Key.

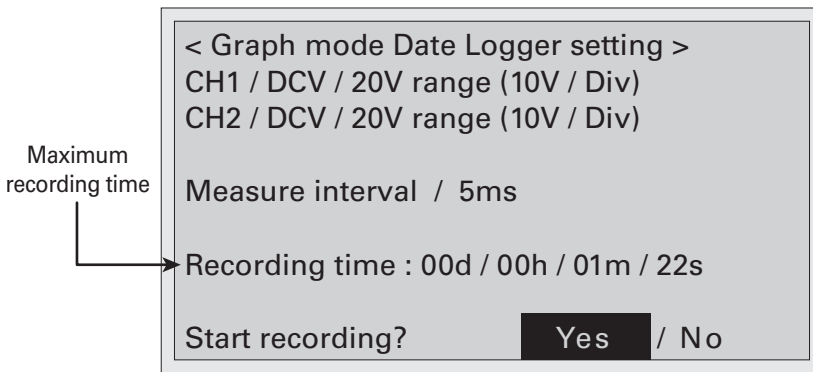

- ④ **REC** symbol appears on the screen, and start data logging.

  - **REC** lights up during data logging. All keys are locked except for LOG/CAPTURE Key.
  - LCD backlight turns off when battery operation.
  - Data logging is automatically stopped when battery level becomes **⊗**.

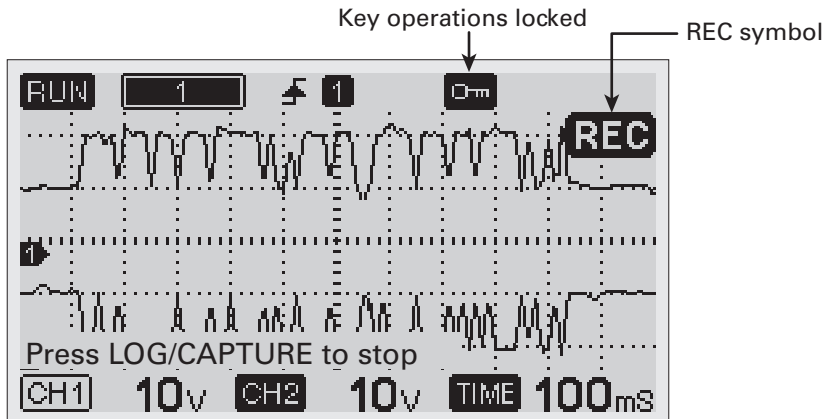

## DATA LOGGING / CAPTURE

- ⑤ To stop data logging, press LOG/CAPTURE Key, then select "YES". The screen shows [Now Saving...], and the logged data is saved automatically. When the data saving is done, "OK" appears on the screen.
- ⑥ The instrument restarts after finishing data saving.

## 2. Screen Capture

You can capture and save the frozen screen as PNG format. This function is available for both Graph and DMM modes (except for Continuity Test). The captured data can be recalled on the screen (see page 58 "Recall Captured Data").

The captured data can be moved to PC enable to see with image viewing software (see page 61).

※ You can see the colored image on the PC screen. The waveforms and the cursors are color-coded by channel for more visually checking.

- ① Display the waveform (Graph mode) or numeric data (DMM mode, except for Continuity Test).
- ② Press RUN/HOLD Key to freeze the screen.
- ③ Press LOG/CAPTURE Key.
- ④ Camera symbol appears on the screen. "OK" appears when the saving is done.

Screen frozen

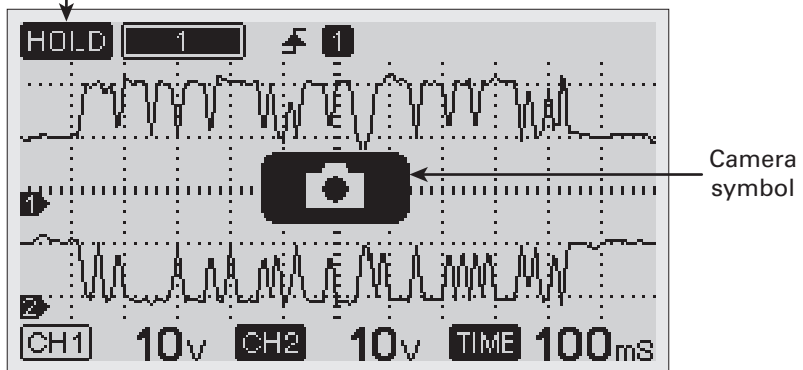

## HELP FUNCTION

Use this function when you have questions in the operation.

Press HELP Key : Help lists with the useful hints or tips are displayed on the screen.

To close the screen : Press HELP Key again.

Example of Help screen

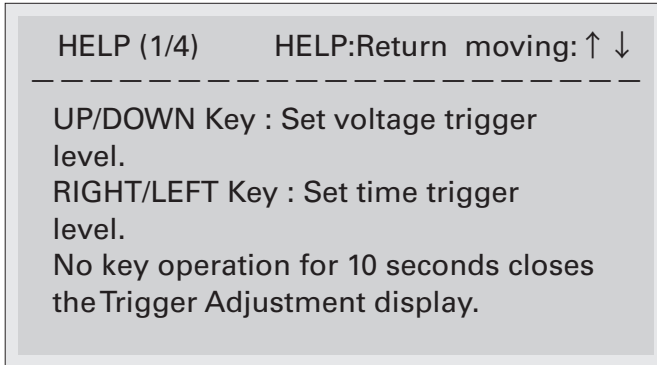

## SETTINGS - MENU SCREEN

You can make various settings in Menu screens. Press MENU Key to open.

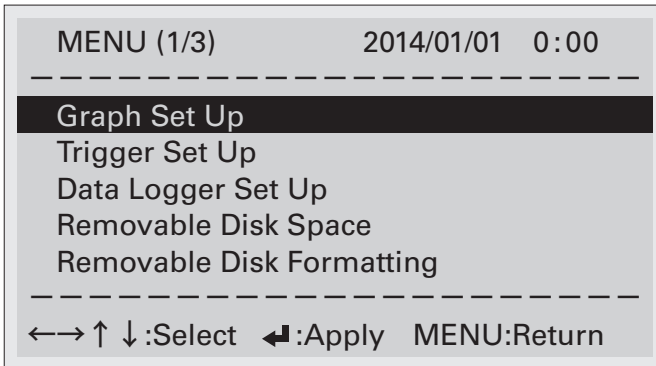

- ←/→ Keys : Change the pages (1/3, 2/3 and 3/3)
- ↑ ↓ Keys : Select the setting item (highlighted)
- ↵ (ENTER) Key : Open the selected menu
- Press MENU Key again : Back to the previous screen, or close MENU screen.



### 1. Graph Set Up

In Graph mode, the waveform is divided into 3-screens when the time axis is set to 20mS or less. This menu can set the waveform area to display on the screen.

- ① Select **Graph Set Up** and press ↵ (ENTER) Key.
- ② Press ↵ (ENTER) Key in **Graph Set Up** menu. The highlighted part is flashing.
- ③ Select the waveform display area with ↑ ↓ Keys. Press ↵ (ENTER) Key to fix.
- ④ Press MENU Key to close the screen.

- Area 1 : Left side of the waveform is displayed with  symbol.
- Area 2 : Center of the waveform is displayed with  symbol.
- Area 3 : Right side of the waveform is displayed with  symbol.





※ This setting is not needed when the time axis is set to 50mS or more. The whole waveform is displayed on the screen with  symbol.

# SETTINGS - MENU SCREEN

## 2. Trigger Set Up







### ●Trigger

Set ON / OFF of the trigger function.

- ① Select **Trigger Set Up** and press  (ENTER) Key.
- ② Select **Trigger** and press  (ENTER) Key. The highlighted part is flashing.
- ③ Select ON / OFF with   Keys. Press  (ENTER) Key to fix.
- ④ Press MENU Key to close the screen.
  - ON : Trigger function is activated.
  - OFF : Trigger function is deactivated.







### ●Slope

Set the trigger slope either Rising / Falling.

- ① Select **Trigger Set Up** and press  (ENTER) Key.
- ② Select **Slope** and press  (ENTER) Key. The highlighted part is flashing.
- ③ Select Rise / Fall with   Keys. Press  (ENTER) Key to fix.
- ④ Press MENU Key to close the screen.
  - Rise : Triggering when the waveform is rising against trigger level (  lights up).
  - Fall : Triggering when the waveform is falling against trigger level (  lights up).

### ●Channel

Select the channel to apply the triggering.

- ① Select **Trigger Set Up** and press  (ENTER) Key.
- ② Select **Channel** and press  (ENTER) Key. The highlighted part is flashing.
- ③ Select CH1 / CH2 with   Keys. Press  (ENTER) Key to fix.
- ④ Press MENU Key to close the screen.
  - CH1 : Triggering on the waveform of channel-1 (  lights up).
  - CH2 : Triggering on the waveform of channel-2 (  lights up).

# SETTINGS - MENU SCREEN

## 3. Data Logger Set Up

### ● Graph Mode

- ① Select **Data Logger Set Up** and press **↵** (ENTER) Key.
- ② Set measuring interval (Time/Div) in page 1/5.  
Press **↵** (ENTER) Key, then the highlighted part is flashing.

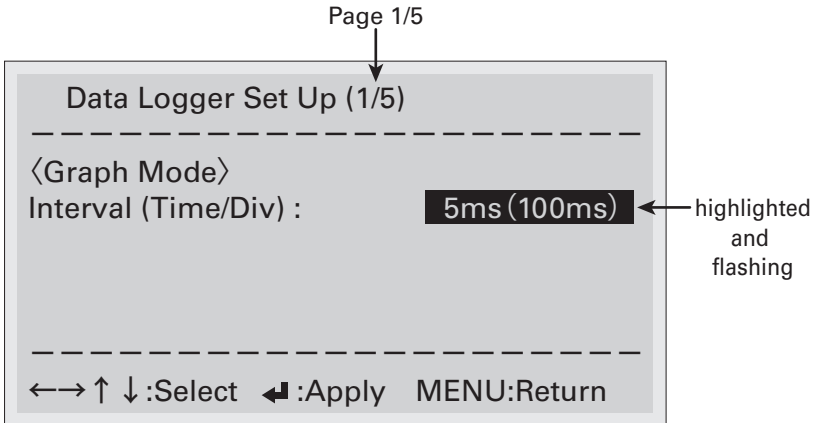

- ③ Select the interval with **↑ ↓** Keys. Press **↵** (ENTER) Key to fix.
  - You can choose following intervals by pressing **↑ ↓** Keys.  
5ms (100ms)→10ms (200ms)→25ms (500ms)→50ms (1s)→100ms (2s)→  
250ms (5s)→500ms (10s)→1s (20s)→3s (60s)→6s (2min)→15s (5min)→  
30s (10min)→60s (20min)→ back to 5ms (100ms)
- ④ Press **→** Key and go to page 2/5. Set data logger ON/OFF and measurement ranges of CH1 and CH2. Use **↑ ↓** Keys to select and press **↵** (ENTER) Key to flash the item.

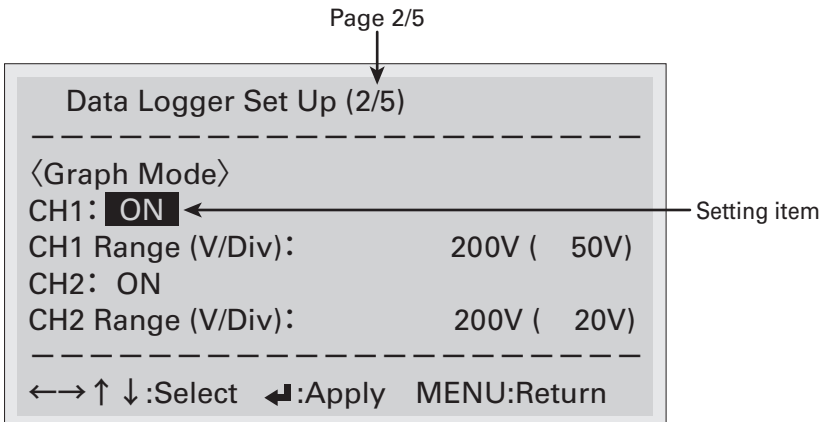

## SETTINGS - MENU SCREEN

⑤ Set the following items with ↑ ↓ Keys. Press ↵ (ENTER) Key to fix.

- CH1:

Data Logger ON or OFF for channel-1.

- CH1 Range (V/Div):

Measurement range for CH1. You can choose following ranges by pressing ↑ ↓ Keys.

2V (200mV)→2V (500mV)→2V (1V)→20V (2V)→20V (5V)→20V (10V)→  
200V (20V)→200V (50V)→200V (100V)→1000V (200V)→1000V (500V)→  
back to 2V (200mV)

- CH2:

Data Logger ON or OFF for channel-2.

- CH2 Range (V/Div):

Measurement range for CH2. You can choose following ranges by pressing ↑ ↓ Keys.

2V (200mV)→2V (500mV)→2V (1V)→20V (2V)→20V (5V)→20V (10V)→  
200V (20V)→200V (50V)→200V (100V)→1000V (200V)→1000V (500V)→  
back to 2V (200mV)

⑥ Press MENU Key to close the screen.

※ Scan measurement is applied for channel-2.

### ● DMM Mode

① Press → Key and go to page 3/5.

② Set measuring interval and input (DCV / ACV).

Use ↑ ↓ Keys to select and press ↵ (ENTER) Key to flash the setting item.

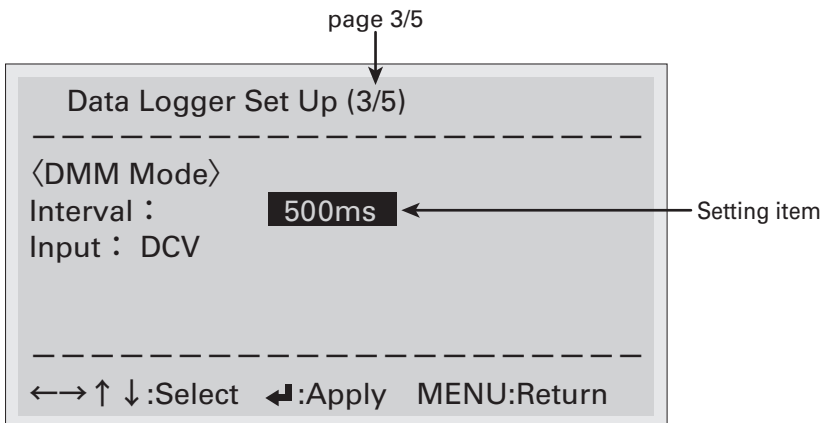



## SETTINGS - MENU SCREEN

- Interval:

You can choose following intervals by pressing ↑ ↓ Keys.

500ms→1s→3s→6s→15s→30s→60s→back to 500ms

- Input:

Set the input voltage (DCV / ACV) that can apply data logging in DMM mode.

※Data logging for AC voltage cannot be made when setting DCV.

※Data logging for DC voltage cannot be made when setting ACV.

※Dual channel logging is not available for ACV. Either CH1 or CH2 is recordable.

If both channels are set to ON in pages 4/5 and 5/5, CH1 is recorded.

③ Press → Key and go to page 4/5.

④ Make CH1 settings. Set data logger ON/OFF and measurement ranges for DCV and ACV. Use ↑ ↓ Keys to select and press ↵ (ENTER) Key to flash the setting item.

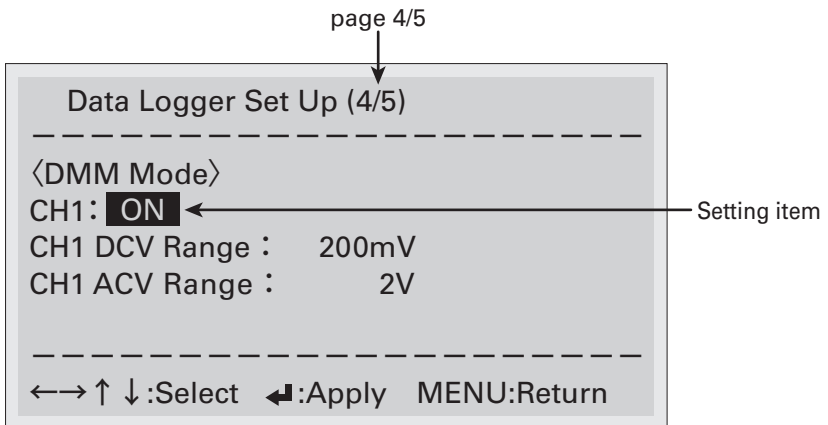

⑤ Set the following items with ↑ ↓ Keys. Press ↵ (ENTER) Key to fix.

- CH1:

Data Logger ON or OFF for channel-1.

- CH1 DCV Range:

DCV measurement range for CH1.

You can choose following ranges by pressing ↑ ↓ Keys.

200mV→2V→20V→200V→1000V→ back to 200mV

- CH1 ACV Range:

ACV measurement range for CH1.

You can choose following ranges by pressing ↑ ↓ Keys.

2V→20V→200V→600V→ back to 2V

## SETTINGS - MENU SCREEN

⑥ Press → Key and go to page 5/5.

Make CH2 settings. Set data logger ON/OFF and measurement ranges for DCV and ACV. Use ↑ ↓ Keys to select and press ↵ (ENTER) Key to flash the setting item.

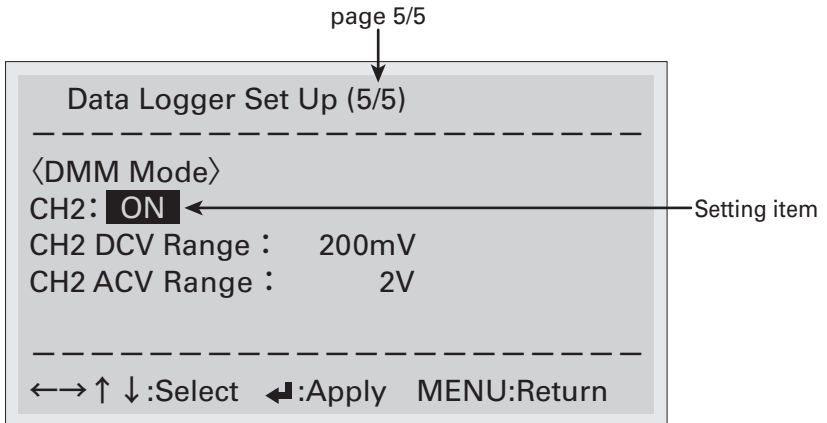

⑦ Set the following items with ↑ ↓ Keys. Press ↵ (ENTER) Key to fix.

- CH2:

Data Logger ON or OFF for channel-2.

- CH2 DCV Range:

DCV measurement range for CH1.

You can choose following ranges by pressing ↑ ↓ Keys.

200mV→2V→20V→200V→1000V→ back to 200mV

- CH2 ACV Range:

ACV measurement range for CH1.

You can choose following ranges by pressing ↑ ↓ Keys.

2V→20V→200V→600V→ back to 2V

⑨ Press MENU Key to close the screen.

※ Scan measurement is applied for channel-2.

## SETTINGS - MENU SCREEN

### 4. Removable Disk Space

You can check free space of the removable disk of this instrument.

- ① Select **Removable Disk Space** and press **↵** (ENTER) Key.
- ② Free disk space is displayed on the screen.

Screen example

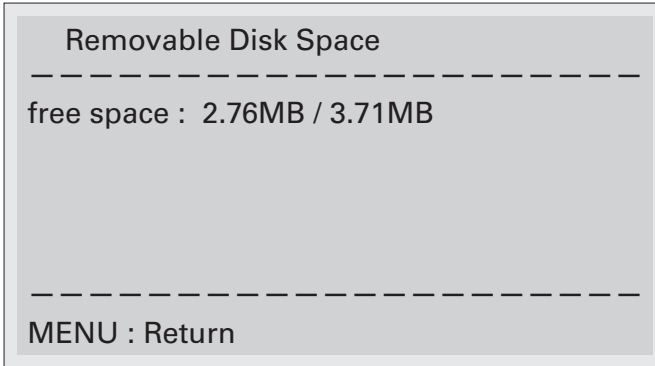

### 5. Removable Disk Formatting

Format the removable disk of the instrument and delete the all recorded data.

- ① Select **Removable Disk Formatting** and press **↵** (ENTER) Key.
- ② Press **↵** (ENTER) Key. The highlighted part is flashing.
- ③ Select Yes / No with **↑ ↓** Keys.

To format the disk, select "Yes" and press **↵** (ENTER) Key.

The all recorded data are deleted when executing the disk format.

- ④ Press MENU Key to close the screen.

## SETTINGS - MENU SCREEN

### 6. USB Removable Disk Set Up

Use when connecting to PC. See page 61 for details.

- ① Select **USB Removable Disk Set Up** and press **↵** (ENTER) Key.
  - ② Press **↵** (ENTER) Key. The highlighted part is flashing.
  - ③ Select connect / disconnect with **↑ ↓** Keys. Press **↵** (ENTER) Key to fix.
    - Disconnect (default) : Not connected to PC.
    - Connected : Open PC connection screen.
- ※ To stop PC connection, eject SK-2500 from PC by "Safety Remove Hardware" process.  
Then, turn off the instrument by pressing POWER Key.

### 7. Recall Captured Data

Select the captured image data to recall on the screen.

- ① Select **Recall Captured Data** and press **↵** (ENTER) Key.
- ② Select the data that you want to see and press **↵** (ENTER) key.  
(Use **←/→** Keys to change the pages.)
  - ※ Captured data is named as below.

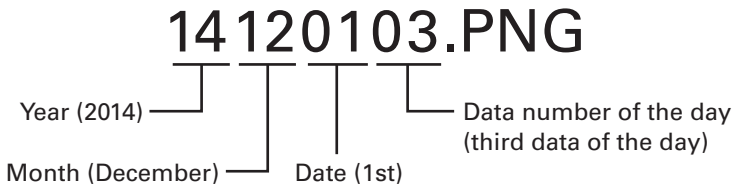

- ③ The selected image data is displayed on the screen.
- ④ Press MENU Key to go back to the data list screen.
- ⑤ Press MENU Key again to close the screen.

## SETTINGS - MENU SCREEN

### 8. Delete Capture/Log Data

Delete the captured and logged data saved in this instrument.

- ① Select **Delete Capture/Log Data** and press **↵** (ENTER) Key.
- ② Select the data that you want to delete and press **↵** (ENTER) key.  
(Use **←/→** Keys to change the pages.)
- ③ Confirmation screen is displayed. Select Yes / No with **↑ ↓** Keys. Press **↵** (ENTER) Key.
- ④ Go back to data list screen after the deleting is done.
- ⑤ Press MENU Key to close the screen.

### 9. Contrast Set Up

Adjust the contrast of the screen.

- ① Select **Contrast Set Up** and press **↵** (ENTER) Key.
- ② Press **↵** (ENTER) Key. The highlighted part is flashing.
- ③ Change the contrast with **↑ ↓** Keys. Press **↵** (ENTER) Key to fix.
  - Settable contrast tone : 1 (brighter) >>>> 32 (darker)
- ④ Press MENU Key to close the screen.

### 10. Back Light Set Up

Set ON / OFF of the screen back light.

- ① Select **Back Light Set Up** and press **↵** (ENTER) Key.
- ② Press **↵** (ENTER) Key. The highlighted part is flashing.
- ③ Select ON / OFF with **↑ ↓** Keys. Press **↵** (ENTER) Key to fix.
  - ON : Turn on the back light
  - OFF : Turn off the back light
- ④ Press MENU Key to close the screen.

### 11. Auto Power Off

If Auto Power Off is activated, the instrument turns off automatically after a lapse of 30 minutes. (default setting : OFF)

- ① Select **Auto Power Off** and press **↵** (ENTER) Key.
- ② Press **↵** (ENTER) Key. The highlighted part is flashing.
- ③ Select ON / OFF with **↑ ↓** Keys. Press **↵** (ENTER) Key to fix.
  - ON : Activate auto power off.
  - OFF : Deactivate auto power off.
- ④ Press MENU Key to close the screen.

## SETTINGS - MENU SCREEN

### 12. Calendar Set Up

Set the calendar, date and time.

- ① Select **Calendar Set Up** and press ◀ (ENTER) Key.
- ② Press ◀ (ENTER) Key. The Year is highlighted with flashing.
- ③ Set the Year with ↑ ↓ Keys. Press → Key to set Month, Date, and Time.
- ④ After the settings are done, press ◀ (ENTER) Key.
- ⑤ Press MENU Key to close the screen.

### 13. Language Set Up

Change the language, either English / Japanese. (default setting : English)

- ① Select **Language Set Up** and press ◀ (ENTER) Key.
- ② Press ◀ (ENTER) Key. The highlighted part is flashing.
- ③ Select English / Japanese with ↑ ↓ Keys. Press ◀ (ENTER) Key to fix.
- ④ Press MENU Key to close the screen.

### 14. Click Sound Set Up

Set ON / OFF of the key click sound. (default setting : ON)

- ① Select **Click Sound Set Up** and press ◀ (ENTER) Key.
- ② Press ◀ (ENTER) Key. The highlighted part is flashing.
- ③ Select ON / OFF with ↑ ↓ Keys. Press ◀ (ENTER) Key to fix.
  - ON : Key sound ON
  - OFF : Key sound OFF
- ④ Press MENU Key to close the screen.

### 15. System Information

You can see model name, software version number, and serial number of the instrument.

- ① Select **System Information** and press ◀ (ENTER) Key.
- ② Model name / Soft version number / Serial number are displayed.
- ③ Press MENU Key to close the screen.

## PC CONNECTION

Connect the instrument to the PC with the provided USB cable. You can move the captured and logged data saved in the instrument to PC.

- Logged data is saved as CSV format. You can make data processing in spreadsheet software like Excel.

※For details of data processing, see the manuals of the spreadsheet software.

- Captured data is saved as PNG format that can see in image viewing software like Windows photo viewer.

※You can see the colored image on the PC screen. The waveforms and the cursors are color-coded by channel for more visually checking.

- ① Turn on the instrument with BATTERY power.
- ② Press MENU Key and open MENU screen. Select **USB Removable Disk Set Up** and press **↵** (ENTER) Key. (see page 58)
- ③ Press **↵** (ENTER) Key again. The highlighted part is flashing.
- ④ Select **connect** with **↑ ↓** Keys, and press **↵** (ENTER) Key. PC connection screen is displayed as below.

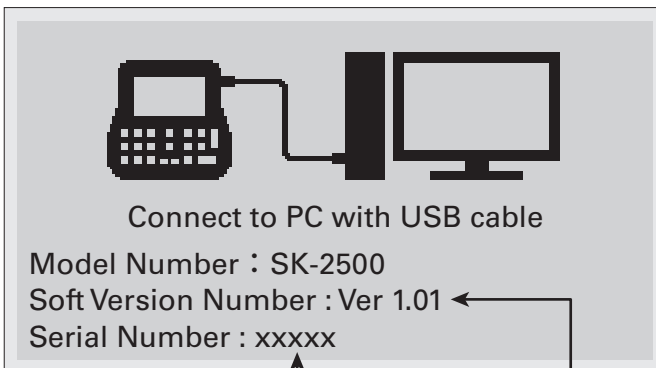

Serial number

Software version  
(number is changed if upgraded)

## PC CONNECTION

⑤ Connect the instrument to PC with the provided USB cable.

※ **STOP** measurement when connecting to PC.

※ Make the USB connection after the message “Connect to PC with USB cable” is displayed on the screen. **DO NOT** connect while displaying “Prepare PC Connect…”.

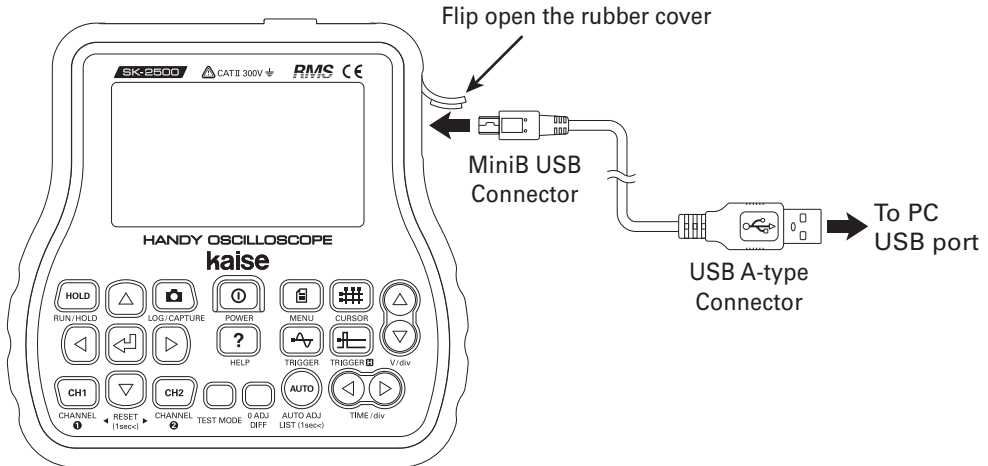

⑥ When PC connection is done, the instrument is recognized as mass-storage device. Confirm KAISE SK-2500 USB Device is displayed on the PC.

⑦ You can move the data to PC.

⑧ To stop PC connection, eject SK-2500 from PC by “Safety Remove Hardware” process. Then, turn off the instrument by pressing POWER Key.

※ If your PC does not recognize the SK-2500, try to use another USB port or to connect through commercially available USB hub.

※ If you cannot connect to PC after trying above, contact your local dealer or us, Kaise Corporation (e-mail : sales@kaise.com).



# MAINTENANCE

## 1. Battery Replacement



### WARNING

Read "SAFETY PRECAUTIONS" in pages 1 to 6 carefully before installing the batteries. Strictly observe the warnings and cautions.

Replace the batteries when  appears on the screen. Proceed as follows.

- ① Detach the instrument from the vehicle or the PC. Turn off the instrument.
  - ② Remove rubber holster from the instrument.
  - ③ Loosen two screws on the battery cover. Lift the battery cover and remove it.
  - ④ Remove the old batteries. Install the four new batteries with the correct polarity as plus ⊕ and minus ⊖ pictorial indications.
  - ⑤ Fix the battery cover and tighten the screws.
  - ⑥ Put rubber holster over the instrument.
- ※ Remove the batteries when the instrument is out of use for a long time. The exhausted batteries might leak electrolyte and corrode the inside.

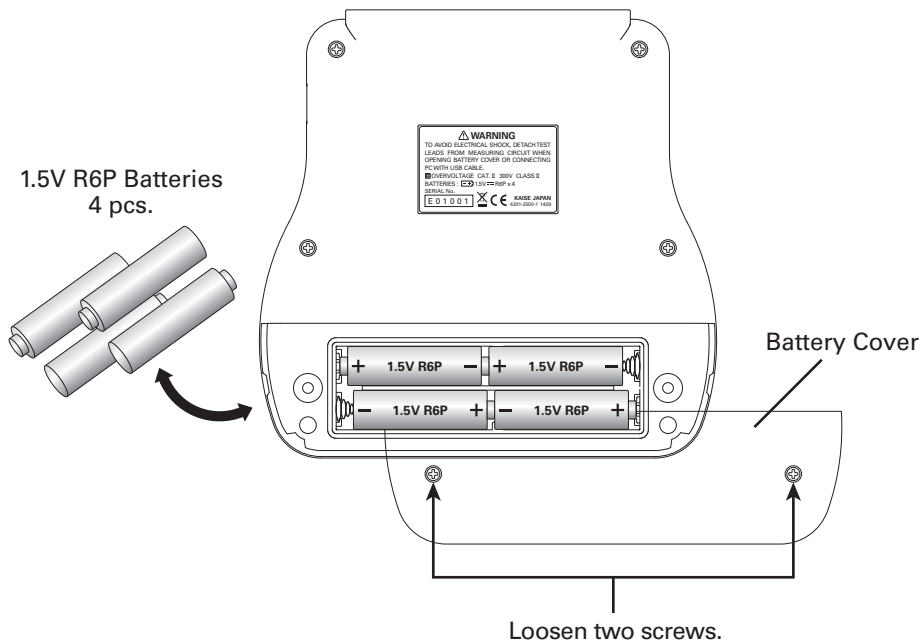

## MAINTENANCE

### 2. Periodical Check and Calibration

Periodical check and calibration is necessary to make safety measurements and to maintain the specified accuracy. The recommended check and calibration term is once a year and after the repair service. This service is available at KAISE AUTHORIZED SERVICE AGENCY through your local dealer.

### 3. Backup Battery

Backup battery is installed in the instrument to maintain the calendar. When this battery becomes weak, the calendar does not work correctly. In that case, ask KAISE AUTHORIZED SERVICE AGENCY through your local dealer for replacement.

## SOFTWARE UPGRADE

Software of SK-2500 is upgraded when needed. When the new software is available, we will notify on our website. Please access following URL, and upgrade the software.

Product Website for SK-2500 Handy Oscilloscope  
[http://www.kaise.com/automotive\\_2500E.htm](http://www.kaise.com/automotive_2500E.htm)



You can also access the above website from the main page of our Automotive Testers.

KAISE CORPORATION - Automotive Testers  
[http://www.kaise.com/automotive\\_topE.htm](http://www.kaise.com/automotive_topE.htm)



#### (1) Software Upgrade

The upgraded software can be downloaded from the above website at free of charge. Read the procedure and execute the upgrade at your side.

#### (2) Product Documents

You can see the product details and tips in the above website. Downloading of brochure and instruction manual is also available in PDF formats.

The latest product information is updated on our website upon available.

## TROUBLE SHOOTING

If there are any failure with this instrument, check the following issues before asking repair service. Ask KAISE CORPORATION AUTHORIZED SERVICE AGENCY through your local dealer for any questions or troubles.

Symptoms	Causes and Necessary Actions
Cannot turn on the instrument	<ul style="list-style-type: none"><li>● Batteries become weak. → Replace batteries.</li><li>● Batteries are installed in wrong polarity. → Re-install the batteries with correct polarity.</li><li>● Loose-inserting of USB connector when using USB connection. → Re-insert the USB connector firmly.</li></ul>
Backlight turns off when logging the data	<ul style="list-style-type: none"><li>● It is normal. The backlight is turned off when making data logging with battery power supply to conserve the battery life.</li></ul>
Calender does not work	<ul style="list-style-type: none"><li>● Built-in backup battery become weak. → Ask KAISE AUTHORIZED SERVICE AGENCY through your local dealer for replacement.</li></ul>

## WARRANTY

SK-2500 are warranted in its entirety against any defects of material or workmanship under normal use and service within a period of one year from the date of purchase of the original purchaser. Warranty service is available at KAISE AUTHORIZED SERVICE AGENCY through your local dealer. Their obligation under this warranty is limited to repairing or replacing SK-2500 returned intact or in warrantable defect with proof of purchase and transport charges prepaid. KAISE AUTHORIZED DEALER and the manufacturer, KAISE CORPORATION, shall not be liable for any consequential damages, loss or otherwise. The foregoing warranty is exclusive and in lieu of all other warranties including any warranty of merchantability, whether expressed or implied.

This warranty shall not apply to any instrument or other article of equipment which shall have been repaired or altered outside of KAISE AUTHORIZED SERVICE AGENCY, nor which have been subject to misuse, negligence, accident, incorrect repair by users, or any installation or use not in accordance with instructions provided by the manufacturer.



# KAISE CORPORATION

422 Hayashinogo, Ueda City, Nagano Pref., 386-0156 Japan

TEL : +81-268-35-1601 / FAX : +81-268-35-1603

E-mail : sales@kaise.com <http://www.kaise.com>

KAISE AUTHORIZED DEALER

Product specifications and appearance are subject to change without notice due to continual improvements.