

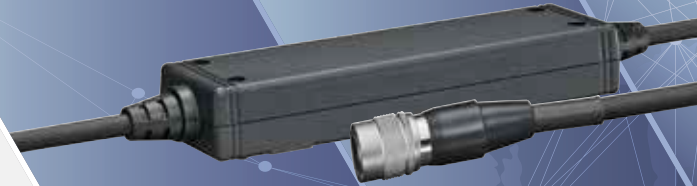

500 A Rated Specifications

Flagship model



Ultra-High Performance
AC/DC Current Sensor



800 A Rated Specifications

World-Class Accuracy & Measurement Range

- 500 A (rms), 800 A (rms) Rated for measurement of large currents
- 4 MHz (± 3 dB) Wide measurement frequency range
- ± 10 ppm Excellent linearity (500 A rated specifications)
- $\pm 0.02\%$ rdg. ($\pm 0.007\%$ f.s.) Superior basic measurement accuracy (500 A rated specifications)
- 120 dB (100 kHz) High Common-Mode Rejection Ratio (CMRR)



For True Current Measurement

High inverter efficiency and improved power saving technology performance for the power electronics, natural energy, and automotive industries.
Responding to the advanced demands of every industrial field.

AC/DC Current Sensor CT6904



Specifications

Rated **500 A** (rms)

Model: CT6904

Measurement Frequency Range

4 MHz
(±3 dB)

Linearity

±10 ppm

Measurement Accuracy

±0.02% rdg.
(±0.007% f.s.)

CMRR

120 dB
(100 kHz)

Rated **800 A** (rms)

Model: CT6904-60

Measurement Frequency Range

4 MHz
(±3 dB)

Linearity

±12.5 ppm

Measurement Accuracy

±0.025% rdg.
(±0.009% f.s.)

CMRR

120 dB
(100 kHz)



Diagram to scale

>>> High Performance Combination

POWER ANALYZER PW6001

Achieve maximum performance
when used in combination
with the POWER ANALYZER
PW6001



Superior Performance

World-Class Measurement Frequency Range of 4 MHz

> Online Library



See here for technical documents on phase compensation in current sensors.

Current sensor performance is maximized with the "Zero Flux (Fluxgate Detection)" measurement method.

High-frequency currents are detected with the winding (CT method), and DC to low frequency currents are detected with the "flux gate."

Newly developed opposed split coil technology *1 is used in winding (CT) areas, achieving a wide measurement range from DC to 4 MHz.

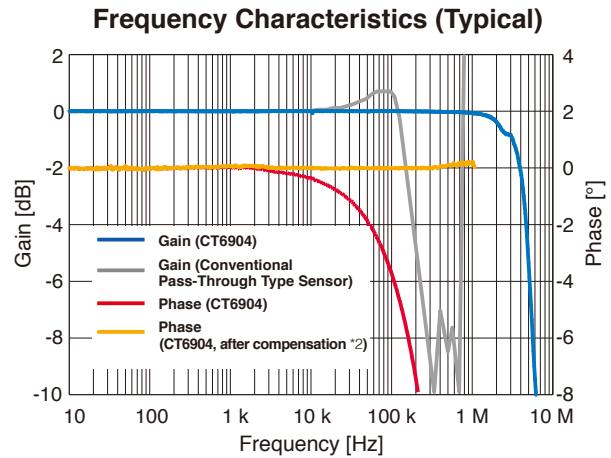
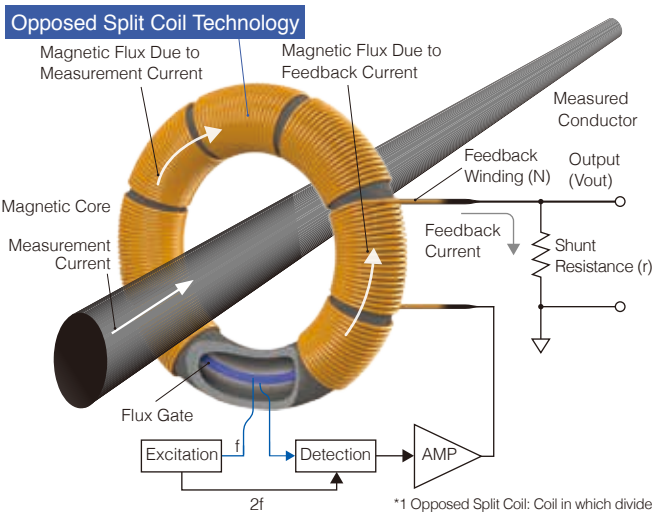

*1 Opposed Split Coil: Coil in which divided windings are arranged opposite each other on a magnetic core to broaden the range of current detection
 *2 When performing phase compensation with HIOKI POWER ANALYZER PW6001

High Accuracy and Measurement Stability

±10 ppm Linearity, ±0.02% rdg. ±0.007% f.s. Basic Accuracy (500 A Rated Specifications)

By using a fluxgate element for DC to low frequency current detection, we have been able to achieve a level of measurement accuracy and temperature stability that is not possible with the Hall element method.

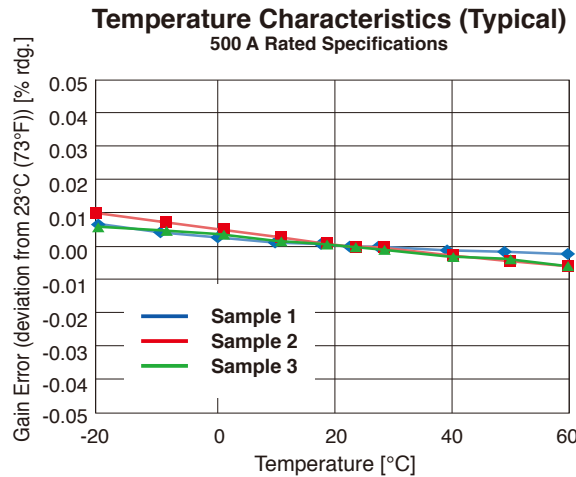
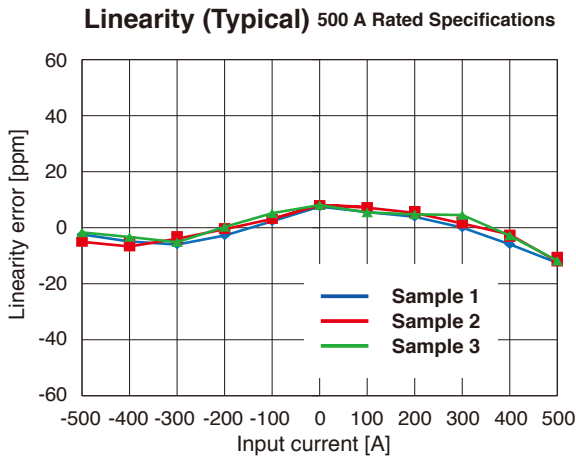

Linearity: Changes the input current (DC) at intervals of 100 A from +500 A to 0 A to -500 A to 0 A to +500 A to measure the output voltage. Determined by the difference between the regression line (calculated from the above measurements) and measurement points.

High Noise Resistance

Common-Mode Rejection Ratio (CMRR) of 120 dB or More (100 kHz)

The opposed split coil is completely shielded with a uniquely shaped solid shield, achieving both broad bandwidth and superior noise resistance.

This allows accurate measurement without influence from surrounding voltage.

Solid Shield

Aluminum shield machined into a unique shape to eliminate influence on current measurements



Common-Mode Voltage Rejection Ratio (Typical)

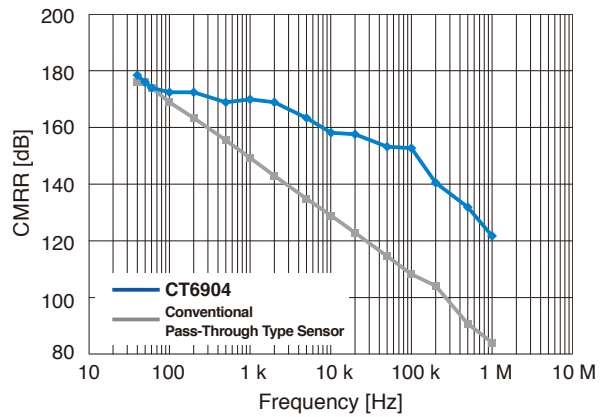

Significant Resistance to Conductor Position Effects Stable Measurement with High Reproducibility

The solid shield not only improves noise resistance but also significantly reduces the effect from the conductor position. Even at high frequency, the conductor position has little effect on measurement values, enabling measurements with high reproducibility.



Position: A to F

Comparison of Effect of Conductor Position on Inner Core (CT6904 and Conventional Model)

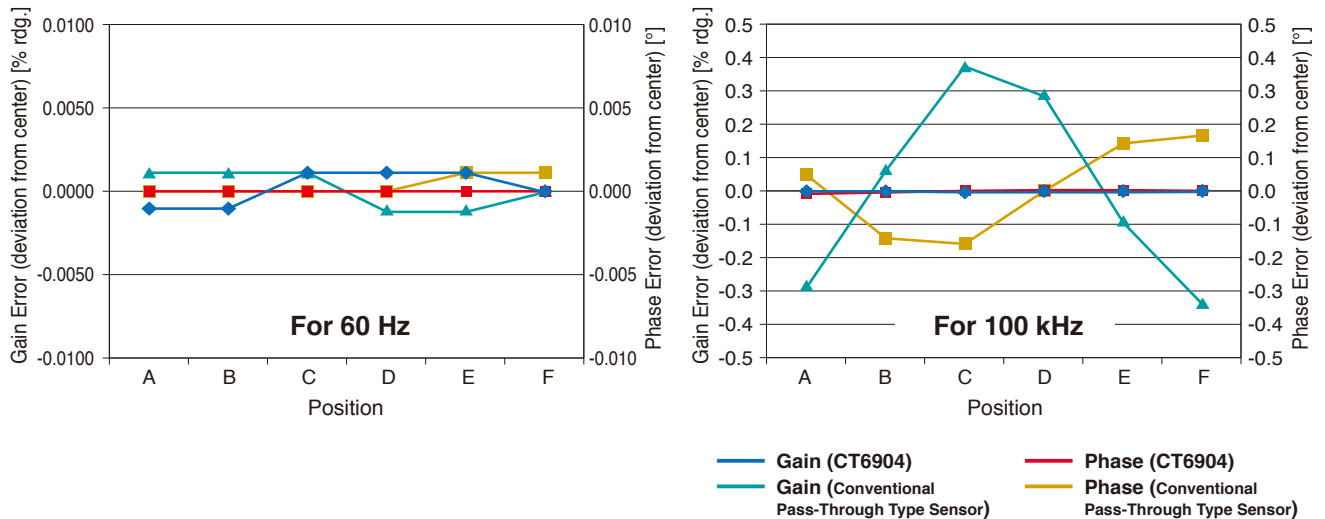

Unmatched Measurement Range and Noise Resistance

Example Applications

> Online Library

High-Precision and Efficiency Testing of SiC/GaN Inverters

A wide range and small voltage current phase error are essential for the highly precise measurement of switching frequency power during PWM output.



See here for technical documents on SiC inverter power measurements.

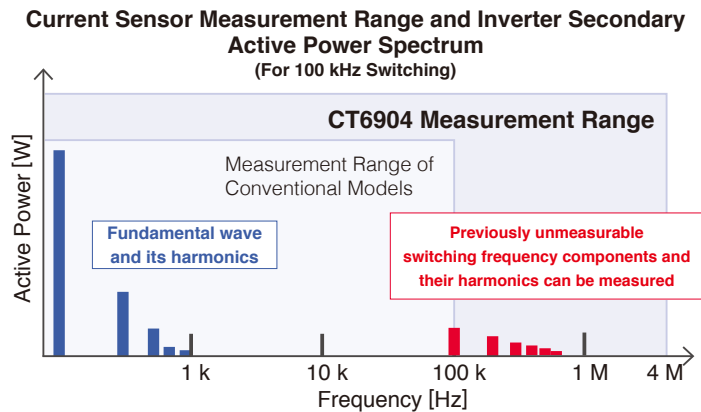
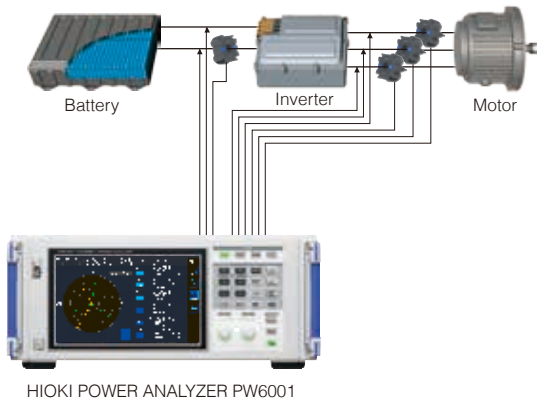

The CT6904 features flat frequency characteristics over a wide range to provide accurate measurement of not only fundamental wave current, but also switching frequency current.

Since the CT6904 achieves both wide-range and highly accurate measurement performance, it can be used in combination with a power analyzer for more precise measurements of inverter input/output power and efficiency than ever before.

> Online Library

Reactor/Transformer Loss Analysis

Reactor and transformer loss measurement is becoming increasingly important for furthering the efficiency and miniaturization of power converters.



See here for technical documents on reactor loss measurement.

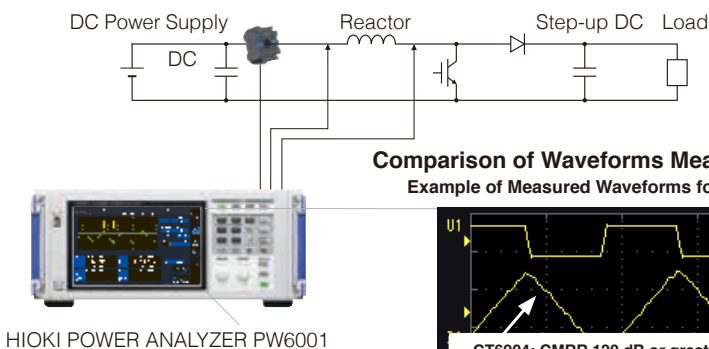

Comparison of Waveforms Measured with the CT6904 versus Conventional Sensor

Example of Measured Waveforms for Switching Current at 100 kHz (Measured with HIOKI PW6001)

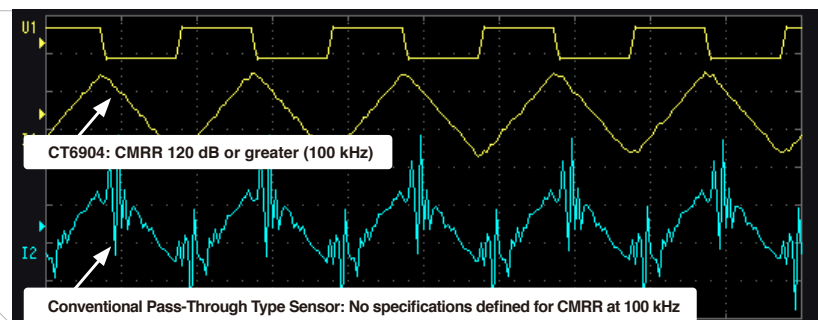

Switching current is often obscured by noise. Thanks to the excellent noise resistance of the CT6904, you can now measure this type of signal with ease.

In addition, by using the phase compensation function of the POWER ANALYZER PW6001, previously difficult reactor and transformer loss measurements for large currents, high frequency, and low power factors can now be performed easily and quickly.

Specifications

General Specifications (Shared specifications for both the 500 A and 800 A rated models)

Operating environment	Indoors, Pollution Degree 2, altitude up to 2000 m (6562.20 ft)
Operating temperature and humidity range	-10°C to 50°C (14°F to 122°F), and 80% RH or less (no condensation)
Storage temperature and humidity range	-20°C to 60°C (-4°F to 140°F), and 80% RH or less (no condensation)
Dielectric withstand voltage	7.4 kV AC (sensed current of 1 mA), 50 Hz/60 Hz: 1 min Distance between feed-through window and cable output terminal
Power supply	Power supplied from PW6001, PW3390, or CT9555* * Operation of the CT9556 or CT9557 in combination with the CT6904 is not guaranteed.
Maximum rated power consumption	7 VA (500 A/55 Hz measurement, with a power supply of ±12 V)
Interface	Dedicated interface (ME15W)
Dimensions	Approx. 139 mm (5.47 in) W × 120 mm (4.72 in) H × 52 mm (2.05 in) D (excluding protrusions and cables)
Output cable length	Approx. 3 m (9.84 ft) (including relay box) (Specifications for an output cable length of 10 m (32.81 ft): Approx. 10 m (32.81 ft) (including relay box))
Bracket hole diameter	φ 5.2 mm (0.20 in) (M5 screws, Recommended tightening torque: 1.5 N • m to 2.0 N • m)
Mass	500 A Rated specifications: Approx. 1.0 kg (35.3 oz) (Specifications for an output cable length of 10 m (32.81 ft): Approx. 1.3 kg (45.9 oz)) 800 A Rated specifications: Approx. 1.1 kg (38.8 oz) (Specifications for an output cable length of 10 m (32.81 ft): Approx. 1.4 kg (49.4 oz))
Product warranty period	3 years
Accessories	- Instruction manual - Carrying case - Color labels (for channel identification)

Basic Specifications

Model	500 A Rated Specifications	800 A Rated Specifications
Rated primary current	500 A AC/DC	800 A AC/DC
Diameter of measurable conductors	φ 32 mm (1.26 in) or less	
Maximum input current	Within derating shown in figure below.	
	However, up to the value below is allowable if within 20 ms (design value). When measuring current in the vicinity of derating, use a cooling time that is 10x or more than the current input time.	
	±1000 A peak	±1200 A peak
Output voltage	4 mV/A	2 mV/A
Maximum rated voltage to ground	1000 V CAT III Expected transient overvoltage: 8000 V	
Linearity	±10 ppm Typical (23°C (73°F))	±12.5 ppm Typical (23°C (73°F))
Offset voltage	±10 ppm Typical (23°C (73°F), no input)	

Accuracy Specifications

Accuracy guarantee conditions	Guaranteed accuracy period: 1 year Guaranteed accuracy period after adjustment made by Hioki: 1 year Temperature and humidity for guaranteed accuracy: 23°C ±5°C (73°F ±9°F), 80% RH or less Warm-up time: 30 min. or more Input waveform: sine wave, Connection: measuring instrument with an input resistance of 0.9 MΩ to 1.1 MΩ Terminal-to-ground voltage: 0 V, no external magnetic field, conductor center position
-------------------------------	---

Frequency	Amplitude		Phase
	500 A Rated specifications	800 A Rated specifications	
DC	±0.025% rdg. ±0.007% f.s.	±0.030% rdg. ±0.009% f.s.	-
DC < f < 16 Hz	±0.2% rdg. ±0.02% f.s.	±0.2% rdg. ±0.025% f.s.	±0.1°
16 Hz ≤ f < 45 Hz	±0.1% rdg. ±0.02% f.s.	±0.1% rdg. ±0.025% f.s.	±0.1°
45 Hz ≤ f ≤ 65 Hz	±0.02% rdg. ±0.007% f.s.	±0.025% rdg. ±0.009% f.s.	±0.08°
65 Hz < f ≤ 850 Hz	±0.05% rdg. ±0.007% f.s.	±0.05% rdg. ±0.009% f.s.	±0.12°
850 Hz < f ≤ 1 kHz	±0.1% rdg. ±0.01% f.s.	±0.1% rdg. ±0.013% f.s.	±0.4°
1 kHz < f ≤ 5 kHz	±0.4% rdg. ±0.02% f.s.	±0.4% rdg. ±0.025% f.s.	±0.4°
5 kHz < f ≤ 10 kHz	±0.4% rdg. ±0.02% f.s.	±0.4% rdg. ±0.025% f.s.	±(0.08xf)°
10 kHz < f ≤ 50 kHz	±1% rdg. ±0.02% f.s.	±1% rdg. ±0.025% f.s.	±(0.08xf)°
50 kHz < f ≤ 100 kHz	±1% rdg. ±0.05% f.s.	±1% rdg. ±0.063% f.s.	±(0.08xf)°
100 kHz < f ≤ 300 kHz	±2% rdg. ±0.05% f.s.	±2% rdg. ±0.063% f.s.	±(0.08xf)°
300 kHz < f ≤ 1 MHz	±5% rdg. ±0.05% f.s.	±5% rdg. ±0.063% f.s.	±(0.08xf)°
Frequency range	4 MHz (±3 dB Typical)		-

- Unit for f in accuracy calculations: kHz. f.s.: Rated primary current.
- Amplitude accuracy and phase accuracy are defined at the rated value or less and 100 Hz or higher is defined within the continuous range of ambient temperature of 50°C (122°F) of the derating in the figure. However, the accuracy defined for the frequency range of DC < f < 10 Hz is the design value.
- For the specifications for an output cable length of 10 m (32.81 ft), add an amplitude accuracy of ±(0.015xf)% rdg. to 50 kHz < f ≤ 1 MHz. The frequency range is 2 MHz (±3 dB Typical).

Effects of temperature	Within the range of -10°C to 18°C (14°F to 64°F) or 28°C to 50°C (82°F to 122°F) Amplitude sensitivity: ±0.005% rdg./°C Offset voltage: ±0.005% f.s./°C Phase: ±0.01°/°C
Common-mode voltage rejection ratio (CMRR)	140 dB or greater (50 Hz/60 Hz), 120 dB or greater (100 kHz) (Effect on output voltage/common-mode voltage)
Effect of conductor position	±0.01% rdg. or less (100 A input, 50 Hz/60 Hz), ±0.2% rdg. or less (10 A input, 100 kHz), when using wire with 10 mm (0.39 in) outer diameter

Derating Characteristics 500 A Rated Specifications

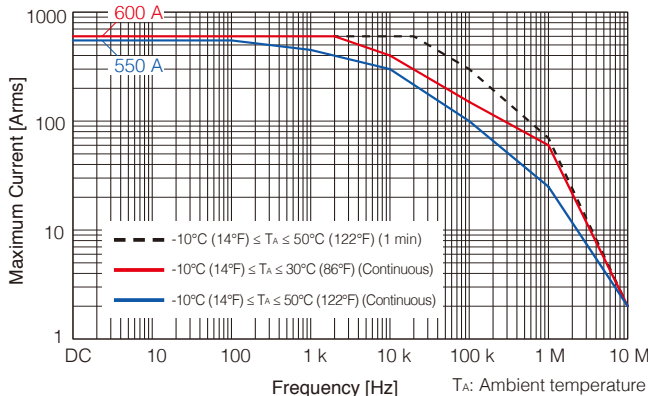

Derating Characteristics 800 A Rated Specifications

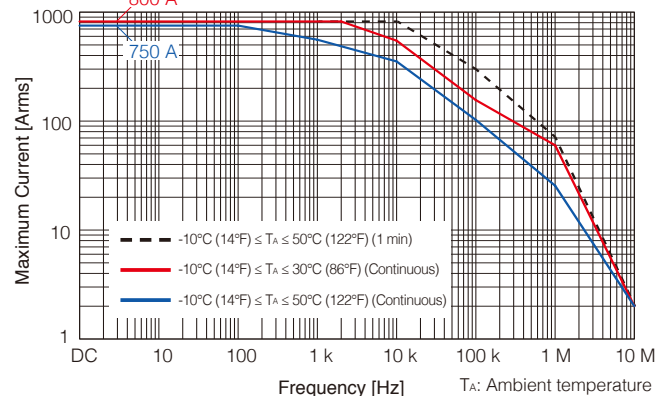

Function Specifications

Combined accuracy with connectable products

1. PW6001 POWER ANALYZER

Frequency	500 A Rated Specifications		800 A Rated Specifications		Phase
	Current	Power	Current	Power	
DC	±0.045% rdg. ±0.037% f.s. (f.s. = PW6001 Range)	±0.045% rdg. ±0.057% f.s. (f.s. = PW6001 Range)	±0.050% rdg. ±0.037% f.s. (f.s. = PW6001 Range)	±0.050% rdg. ±0.057% f.s. (f.s. = PW6001 Range)	PW6001 accuracy + Sensor accuracy
45 Hz ≤ f ≤ 65 Hz	±0.04% rdg. ±0.027% f.s. (f.s. = PW6001 Range)	±0.04% rdg. ±0.037% f.s. (f.s. = PW6001 Range)	±0.045% rdg. ±0.027% f.s. (f.s. = PW6001 Range)	±0.045% rdg. ±0.037% f.s. (f.s. = PW6001 Range)	
Bandwidths other than DC and 45 Hz ≤ f ≤ 65 Hz	PW6001 accuracy + Sensor accuracy (Consider sensor rating when calculating f.s. error.)				

- For other measurement parameters, add the PW6001 accuracy and the sensor accuracy (and consider the sensor rating when calculating the f.s. error).
- 500 A Rated specifications: For 10 A Range and 20 A Range, apply ±0.12% f.s. (f.s. = PW6001 Range)
- 800 A Rated specifications: For 20 A Range and 40 A Range, apply ±0.12% f.s. (f.s. = PW6001 Range)
- Accuracy additions defined by the POWER ANALYZER and sensor specifications also apply.

2. PW3390 POWER ANALYZER

- Add the power analyzer accuracy and the sensor accuracy (and consider the sensor rating when calculating f.s. error).
- Accuracy additions defined by the POWER ANALYZER and sensor specifications also apply.

3. CT9555 SENSOR UNIT

- Sensor accuracy × 1.5 (when the output coaxial cable is no longer than 1.6 m (5.25 ft))
- For the specifications for an output cable length of 10 m (32.81 ft), a frequency range of 1 MHz (±3 dB Typical).
- Accuracy additions defined by the conditions in specifications for connected instruments and sensors also apply.

Phase shift correction value

1. Compensation value when performing phase shift correction with the PW6001 or PW3390 (Typical): 300 kHz -9.82° (Common to 500 A rated specifications and 800 A rated specifications)
- If you would like even more accurate compensation values, the inspection data sheet (sold separately) lists the phase shift correction value for individual items.

Unique Shape Supports a Variety of Installation Scenarios

The longer the measured conductor, the greater the measurement error due to conductor inductance and parasitic capacitance. To keep the sources of error to a minimum, it is necessary to keep the conductor short. With the CT6904 you can select from a variety of installation methods, allowing you to minimize the length of the measured conductor.



Wall Installation Using Screws

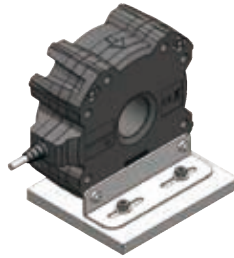

Fastening Bracket (Built-To-Order)

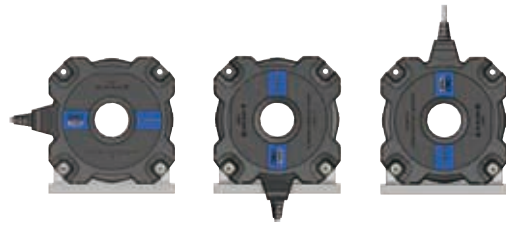

The output cable can face any direction.

Dimensional Drawing (Shared specifications for both the 500 A and 800 A rated models, Unit: mm)

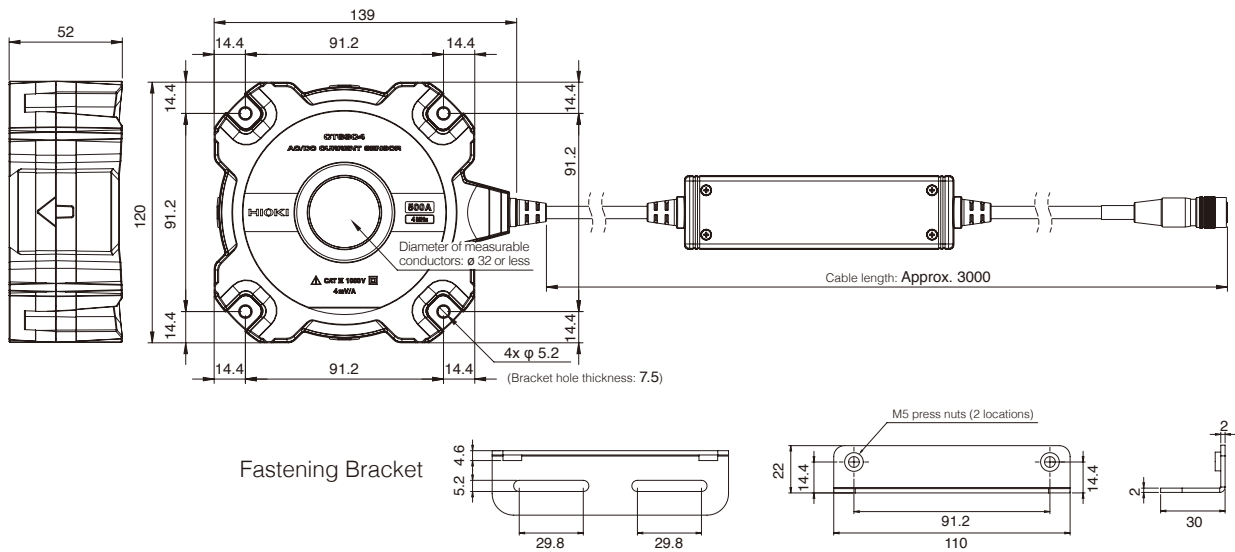

HIOKI ME15W (12-pin terminal)

Fastening Bracket (Built-To-Order)

SENSOR UNIT CT9555 (Option)

Model Name: AC/DC CURRENT SENSOR CT6904

Model No. (Order Code) (Note)

CT6904 (500 A AC/DC Rated, ME15W terminal)

Built-To-Order

Model No. (Order Code) (Note)

CT6904-01 (Output Cable 10 m (32.81 ft) length)

CT6904-60 (800 A AC/DC Rated, ME15W terminal)

CT6904-61 (Output Cable 10 m (32.81 ft) length, 800 A AC/DC Rated)

(Code No. None) Fastening Bracket

Option: SENSOR UNIT CT9555

Model No. (Order Code) (Note)

CT9555 For power supply when using a current sensor by itself, 1 ch, with waveform output

Note: Company names and product names appearing in this catalog are trademarks or registered trademarks of various companies.

HIOKI
HIOKI E. E. CORPORATION

HEADQUARTERS

81 Koizumi,
Ueda, Nagano 386-1192 Japan
<https://www.hioki.com/>



Scan for all regional contact information

DISTRIBUTED BY